

Beechcraft®

Duchess 76®

Pilot's Operating Handbook and FAA Approved Airplane Flight Manual

FAA Approved in the Normal Category based on FAR 23, This document must be carried in the airplane at all times and be kept within reach of the pilot during all flight operations.

This handbook includes the material required to be furnished to the pilot by FAR 23.

Airplane Serial Number: ME-86

Airplane Registration Number: ~~N282B~~ N150SU

FAA Approved: 

A. C. Jackson
Beech Aircraft Corporation
DOA CE-2

COPYRIGHT © BEECH 1994

P/N 105-590000-5
Issued: January, 1978

P/N 105-590000-5A9
Revised: July, 1994

PUBLISHED BY
COMMERCIAL PUBLICATIONS
BEECH AIRCRAFT CORPORATION
WICHITA, KANSAS 67201
U. S. A.

Beechcraft
A Raytheon Company

 Member of GAMA
General Aviation
Manufacturers Association

**DUCHESS 76
PILOT'S OPERATING HANDBOOK
AND
FAA APPROVED AIRPLANE FLIGHT MANUAL**

A9 Revision July, 1994

LOG OF REVISIONS

| Page | Description |
|--------------------|--|
| Title Page | Updated |
| Page A (A9) | New |
| 10-1 thru 10-64 | Revised Section X, Safety Information (May, 1994) |

A9

**DUCHESS 76
PILOT'S OPERATING HANDBOOK
AND
FAA APPROVED AIRPLANE FLIGHT MANUAL**

A8 Revision October, 1990

LOG OF REVISIONS

| Page | Description |
|--------------------|--|
| Title Page | Updated |
| Page A (A8) | New |
| 10-1 thru 10-68 | Revised Section X, Safety Information (October, 1990) |

A8

**BEECHCRAFT DUCHESS 76
Pilot's Operating Handbook
and
FAA Approved Airplane Flight Manual**

A7 September, 1983

LOG OF REVISIONS

| PAGE | DESCRIPTION |
|----------------|--|
| Title Page | Added Revision Date |
| Page A (A7) | Updated |
| a | Revised "Introduction" |
| b | Shifted Material and Revised "Introduction" |
| c and d | Added |
| 1-1 | Revised: "Table of Contents" |
| 1-5 | Revised "Use of the Handbook" |
| 1-6 and 1-6A | Shifted Material |
| 1-10 | Revised "Oil" |
| 1-17 | Revised "Demonstrated Crosswind Velocity" |
| 2-1 | Revised "Table of Contents" |
| 2-5 | Revised "Oil" |
| 2-9 | Shifted Material |
| 2-10 | Revised "Required Equipment for Various Conditions of Flight" |
| 2-11 thru 2-20 | Shifted Material and Revised "Required Equipment for Various Conditions of Flight" |
| 3-1 | Revised: "Table of Contents" |
| 3-3 | Revised "Emergency Airspeeds" |
| 4-1 | Revised: "Table of Contents" |
| 4-3 | Revised: "Speeds for Safe Operation" |
| 4-9 | Added "Hot Start" procedure |
| 4-11 | Revised: "Before Takeoff" |
| 4-12 | Revised: "Climb" |

A7

LOG OF REVISIONS

| Page | Description |
|--------------|--|
| 4-13 | Revised: "Leaning Mixture Using The Exhaust Gas Temperature Indicator (EGT)" |
| 4-14 | Revised: "Descent." |
| 4-14A | Revised: "Shutdown" |
| 4-14B | Added |
| 4-15 | Revised: "Electric Elevator Trim" |
| 5-6 thru 5-8 | Revised: "Introduction to Performance and Flight Planning" |
| 5-21 | Upgraded quality of chart |
| 5-26 | Revised: "Take-off Distance" Graph |
| 5-29 | Revised: "Accelerate-Go Distance" Graph |
| 5-31 | Revised: "Take-off Climb Gradient - One Engine Inoperative" Example |
| 8-16 | Revised: "Oil" and "Battery" |

A7

**BEECHCRAFT DUCHESS 76
Pilot's Operating Handbook
and
FAA Approved Airplane Flight Manual**

A6 January, 1982

LOG OF REVISIONS

| Page | Description |
|------------------|---|
| Title Page | Added Revision Date |
| Logo Page | Added |
| Page A (A6) | Updated |
| 2-20 | Revised "Structural Life" |
| 3-1 | Revised "Table of Contents" |
| 3-3 | Shifted Material |
| 3-4 | Shifted Material |
| 3-5 | Shifted Material |
| 3-6 and 3-7 | Shifted Material and Revised "Air Start" |
| 5-2 | Revised "Table of Contents" |
| 5-35 | Revised "Cruise Speeds" Graph |
| 5-39 | Revised "Cruise Power" Chart |
| 5-40 | Added New "Cruise Power" Chart |
| 5-40A | Added "Intentionally Left Blank" |
| 5-40B | Revised "Range Profile" |
| 5-41 | Revised "Endurance Profile" |
| 7-9 | Revised "Flight Instruments" |
| 7-30 and 7-31 | Revised "External Power" and Shifted Material |
| 8-2 | Revised "Table of Contents" |
| 8-11 | Revised "External Power" |
| 8-46 and 8-47 | Added Preamble to "Consumable Materials" and Shifted Material |

98-38307

A6

LOG OF REVISIONS

| Page | Description |
|------|---|
| 8-53 | Deleted "Landing Gear" and Revised "Power Plant" |
| 8-54 | Shifted Material and Revised "Fuel System", "Electrical System", "Utility System" and Deleted "Instruments" and "Flaps and Flight Controls" |
| 8-55 | Added "Wing Structure Inspection Schedule" and Shifted Material |

A6

98-38307

BEECHCRAFT DUCHESS 76
Pilot's Operating Handbook
and
FAA Approved Airplane Flight Manual

A5August, 1980

LOG OF REVISIONS

| Page | Description |
|----------------|--|
| Title Page | Added Revision Date |
| Page A (A5) | Updated |
| 1-1 and 1-2 | Revised "Table of Contents" |
| 1-4 and 1-5 | Revised "Use of Handbook" |
| 1-6 thru 1-6B | Shifted Material |
| 2-13 | Added "Starter Engaged Warning Light" |
| 3-1 | Revised "Table of Contents" |
| 3-12B | Added "Starter Engaged Warning Light Illuminated" |
| 4-1 | Revised "Table of Contents" |
| 4-9 | Shifted Material |
| 4-10 and 4-10A | Revised "Starting" |
| 4-10B | Revised "After Starting and Taxi" and "Before Takeoff" |
| 4-11 | Shifted Material |
| 5-23 | Revised "Take-Off Weight" Graph |
| 5-42 | Revised "Holding Time" Graph |
| 5-46 | Revised "Landing Distance - Flaps Up" |
| 5-47 | Revised "Landing Distance - Grass Surface - Flaps Down (DN)" Graph |
| 6-1 | Revised "Table of Contents" |
| 6-8 | Shifted Material |
| 6-11 | Revised "Loading Instructions" |
| 7-1 thru 7-3 | Revised "Table of Contents" |
| 7-12 | Added "Warning Horn "Q" Switch" |
| 7-12A | Added "Warning Horn Silence Button" |
| 7-19 | Shifted Material |
| 7-20 and 7-21 | Revised "Starters" |

98-38307

A5

LOG OF REVISIONS

| Page | Description |
|---------------|---|
| 7-29 | Shifted Material |
| 7-30 | Added "Starter Engaged Warning Light" |
| 7-31 | Shifted Material |
| 8-8 | Revised "Jacking" |
| 8-18 | Revised "Tires" |
| 8-36 | Revised "Lubrication Diagrams" |
| 8-42 | Revised "Recommended Servicing Schedule" |
| 8-46 and 8-47 | Revised "Consumable Materials" |
| 8-54 | Revised "Power Plant" |
| | |
| | <div data-bbox="781 1140 1382 1377" style="border: 2px solid black; padding: 10px; text-align: center;">10-1 Thru 10-67 Revised Safety Section Dated March 1981.</div> |
| | |
| | <div data-bbox="1333 1780 1437 1898" style="border: 1px solid black; padding: 5px;">A5</div> |

98-38307

**BEECHCRAFT Duchess 76
Pilot's Operating Handbook
and
FAA Approved Airplane Flight Manual**

A4April, 1980

LOG OF REVISIONS

| Page | Description |
|--------------------------------|------------------------|
| Title Page | Update |
| Page A (A4) | Update |
| 7-16 7-16A 7-16B 7-17 | Revised "Control Lock" |

98-38307

A4

**BEEHCRAFT Duchess 76
Pilot's Operating Handbook
and
FAA Approved Airplane Flight Manual**

A3 October 1979

LOG OF REVISIONS

| Page | Description |
|------------|--------------------------------|
| Title Page | Update |
| "A" Page | Update |
| 2-1 | Revise "Table of Contents" |
| 2-4 | Rearrange Material |
| 2-5 | Add "Fuel Additives" |
| 2-21 | Revise "Placards" |
| 2-26 | Revise "Placards" |
| 4-19 | Revise "Noise Characteristics" |
| 8-47 | Revise "Consumable Materials" |

A3

GENERAL

SECTION I GENERAL

TABLE OF CONTENTS

| <i>SUBJECT</i> | <i>PAGE</i> |
|--|-------------|
| Important Notice | 1-3 |
| Use of the Handbook | 1-4 |
| Revising the Handbook..... | 1-6 |
| Airplane Flight Manual Supplements | |
| Revision Record..... | 1-6A |
| Vendor-Issued STC Supplements | 1-6A |
| Airplane Three View..... | 1-7 |
| Ground Turning Clearance | 1-8 |
| DESCRIPTIVE DATA | 1-9 |
| Engines | 1-9 |
| Propellers..... | 1-9 |
| Fuel..... | 1-10 |
| Oil..... | 1-10 |
| Maximum Certificated Weights..... | 1-10 |
| Standard Airplane Weights..... | 1-11 |
| Cabin and Entry Dimensions | 1-11 |
| Baggage Space and Entry Dimensions | 1-11 |
| Specific Loadings..... | 1-11 |
| SYMBOLS, ABBREVIATIONS, AND TERMINOLOGY... 1-11 | |
| Airspeed Terminology | 1-12 |
| Meteorological Terminology | 1-14 |
| Power Terminology | 1-15 |
| Engine Controls and Instruments Terminology..... | 1-16 |
| Airplane Performance and Flight | |
| Planning Terminology..... | 1-17 |
| Weight and Balance Terminology..... | 1-18 |

INTENTIONALLY LEFT BLANK

THANK YOU . . .

for displaying confidence in us by selecting a BEECHCRAFT airplane. Our design engineers, assemblers, and inspectors have utilized their skills and years of experience to ensure that the new BEECHCRAFT meets the high standards of quality and performance for which BEECHCRAFT airplanes have become famous throughout the world.

IMPORTANT NOTICE

This handbook should be read carefully by the owner and the operator in order to become familiar with the operation of the airplane. Suggestions and recommendations have been made within it to aid in obtaining maximum performance without sacrificing economy. Be familiar with, and operate the airplane in accordance with, the Pilot's Operating Handbook and FAA Approved Airplane Flight Manual, and/or placards which are located in the airplane.

As a further reminder, the owner and the operator should also be familiar with the Federal Aviation Regulations applicable to the operation and maintenance of the airplane, and FAR Part 91, General Operating and Flight Rules. Further, the airplane must be operated and maintained in accordance with FAA Airworthiness Directives which may be issued against it.

The Federal Aviation Regulations place the responsibility for the maintenance of this airplane on the owner and the operator, who should ensure that all maintenance is done by qualified mechanics in conformity with all airworthiness requirements established for this airplane.

All limits, procedures, safety practices, time limits, servicing, and maintenance requirements contained in this handbook

are considered mandatory for continued airworthiness to maintain the airplane in a condition equal to that of its original manufacture.

Authorized BEECHCRAFT Aero or Aviation Centers or International Distributors or Dealers can provide recommended modification, service, and operating procedures issued by both the FAA and Beech Aircraft Corporation, which are designed to get maximum utility and safety from the airplane.

USE OF THE HANDBOOK

The Pilot's Operating Handbook is designed to facilitate maintaining the documents necessary for the safe and efficient operation of the airplane. The handbook has been prepared in loose leaf form for ease in maintenance and in a convenient size for storage. The handbook has been arranged with quick reference tabs imprinted with the title of each section and contains ten basic divisions.

| | |
|------------|--------------------------------------|
| Section 1 | General |
| Section 2 | Limitations |
| Section 3 | Emergency Procedures |
| Section 4 | Normal Procedures |
| Section 5 | Performance |
| Section 6 | Weight and Balance/Equipment List |
| Section 7 | Systems Description |
| Section 8 | Handling, Servicing, and Maintenance |
| Section 9 | Supplements |
| Section 10 | Safety Information |

INTENTIONALLY LEFT BLANK

DUCHESS 76

PILOT'S OPERATING HANDBOOK

AND

FAA APPROVED AIRPLANE FLIGHT MANUAL

TABLE OF DIVISIONS

SECTION I..... GENERAL

SECTION II..... LIMITATIONS

SECTION III..... EMERGENCY PROCEDURES

SECTION IV NORMAL PROCEDURES

SECTION V PERFORMANCE

**SECTION VI WEIGHT AND BALANCE/
EQUIPMENT LIST**

SECTION VII SYSTEMS DESCRIPTION

**SECTION VIII HANDLING, SERVICING
AND MAINTENANCE**

SECTION IX SUPPLEMENTS

SECTION X SAFETY INFORMATION

techniques and materials, and may be dangerous when installed in an airplane.

Salvaged airplane parts, reworked parts obtained from non-BEECHCRAFT approved sources, or parts, components, or structural assemblies, the service history of which is unknown or cannot be authenticated, may have been subjected to unacceptable stresses or temperatures or have other hidden damage, not discernible through routine visual or usual nondestructive testing techniques. This may render the part, component or structural assembly, even though originally manufactured by BEECHCRAFT, unsuitable and unsafe for airplane use.

BEECHCRAFT expressly disclaims any responsibility for malfunctions, failures, damage or injury caused by use of non-BEECHCRAFT approved parts.

BEECHCRAFT
Duchess 76

INTRODUCTION

The format and contents of this Pilot's Operating Handbook and FAA Approved Airplane Flight Manual conform to GAMA (General Aviation Manufacturers Association) Handbook Specification Number 1. Use of this specification by all manufacturers will provide the pilot with the same type of data in the same place in all handbooks.

Attention is called to Section X (SAFETY INFORMATION). BEECHCRAFT feels that it is very important to have Safety Information in a condensed form in the hands of the pilots. The Safety Information should be read and studied. Periodic review will serve as a reminder of good piloting techniques.

WARNING

Use only genuine BEECHCRAFT or BEECHCRAFT approved parts obtained from BEECHCRAFT approved sources, in connection with the maintenance and repair of Beech airplanes.

Genuine BEECHCRAFT parts are produced and inspected under rigorous procedures to insure airworthiness and suitability for use in Beech airplane applications. Parts purchased from sources other than BEECHCRAFT, even though outwardly identical in appearance, may not have had the required tests and inspections performed, may be different in fabrication

**BEECHCRAFT Duchess 76
Pilots Operating Handbook
and
FAA Approved Airplane Flight Manual**

A2April 1979

LOG OF REVISIONS

| Page | Description |
|--------------|--|
| Title Page | Update |
| "A" Page | Update |
| 1-1 & 1-2 | Revise "Table of Contents" |
| 1-3 thru 1-6 | Rearrange Material and Revise Introduction |
| 1-13 | Revise "Airspeed Terminology" |
| 1-15 | Revise "Meteorological Terminology" |
| 1-17 | Revise "Airplane Performance and Flight Planning Terminology" |
| 2-9 | Revise "Required Equipment" |
| 3-1 & 3-2 | Revise "Table of Contents" |
| 3-3 | Revise Information |
| 3-5 | Revise Procedures |
| 3-6 & 3-7 | Revise "Air Start" |
| 3-11 | Revise "Warning" |
| 3-12A | Revise "Illumination of Alternator-out Light" |
| 3-12B | Rearrange Material |
| 3-15 | Remove "Practice Demonstration of V_{MCA} " |
| 3-16 | Rearrange Material |
| 4-1 | Revise "Table of Contents" |
| 4-3 | Revise "Airspeeds" |
| 4-8 & 4-9 | Revise "Starting Engines Using APU" |
| 4-10 | Revise "Starting" and "Caution" |
| 4-11 | Revise "Before Takeoff" |
| 4-12 | Revise "Takeoff" |
| 4-14 | Revise "Balked Landing" |
| 4-16 | Revise "Warning" |
| 4-17 | Rearrange Material |
| 4-18 | Add "Practice Demonstration of V_{MCA} " |
| 4-19 | Revise "Noise Characteristics" |

A2

LOG OF REVISIONS

| Page | Description |
|----------------|---|
| 5-14 | Revise "Comments" |
| 5-44 | Revise "Climb Speed" |
| 5-47 | Revise "Associated Conditions" |
| 6-17 | Revise "Table" |
| 7-1 thru 7-3 | Revise "Table of Contents" |
| 7-9 | Revise "Engine Instrumentation" |
| 7-11 | Add "Time-Delay Relay" |
| 7-12 | Rearrange Material |
| 7-20 & 7-21 | Rearrange Material |
| 7-22 | Add "Fuel Selector Valves" |
| 7-24 & 7-25 | Rearrange Material |
| 7-26 | Revise "Battery" |
| 7-27 | Revise "Power Distribution Schematic" |
| 7-28 & 7-29 | Revise "Alternators" |
| 7-30 | Revise "External Power" |
| 7-31 thru 7-33 | Delete "Charts" |
| 7-39 | Revise "Pilot System" |
| 7-40 | Revise "Static System" |
| 7-41 | Revise "Stall Warning" |
| 8-3 | Revise "Introduction" |
| 8-4 | Revise "Publications" |
| 8-8 thru 8-10 | Revise "Prolonged Out-of-Service Care" |
| 8-11 & 8-12 | Revise "External Power" |
| 8-16 & 8-17 | Revise "Battery" |
| 8-18 | Revise "Shock Struts" |
| 8-20 | Revise "Brakes" |
| 8-26 & 8-27 | Revise "Cleaning" |
| 8-46 & 8-47 | Revise "Consumable Materials" |
| 8-51 | Revise "Bulb Replacement Guide" |
| 8-53 | Revise "Overhaul and Replacement Guide" |

A2

**BEEHCRAFT Duchess 76
Pilot's Operating Handbook
and
FAA Approved Airplane Flight Manual**

A1 Revision.....March 1979

LOG OF REVISIONS

| Page | Description |
|---------------|---|
| Title Page | Update |
| "A" Page | Update |
| 2-12 & 2-13 | Revise "Electrical Power" |
| 3-1 | Revise "Table of Contents" |
| 3-12 | Add "Complete Loss of Electrical Power" |
| 3-12A & 3-12B | Rearrange Material |
| 4-1 | Revise "Table of Contents" |
| 4-9 & 4-10 | Revise "Starting" Procedures |
| 4-10A & 4-10B | Rearrange Material |
| | <div data-bbox="1382 1838 1495 1927" style="border: 1px solid black; padding: 2px; display: inline-block;">A1</div> |

BEECHCRAFT Duchess 76
Pilot's Operating Handbook
and
FAA Approved Airplane Flight Manual

A-Original Issue January 1978

LOG OF REVISIONS

| Page | Description |
|-----------------|------------------------|
| Title Page | — |
| "A" Page | — |
| a and b | — |
| 1-1 thru 1-20 | — |
| 2-1 thru 2-28 | — |
| 3-1 thru 3-17 | — |
| 4-1 thru 4-18 | — |
| 5-1 thru 5-47 | — |
| 6-1 thru 6-18 | — |
| 7-1 thru 7-41 | — |
| 8-1 thru 8-56 | — |
| 9-1 and 9-2 | — |
| Supplements | See Log of Supplements |
| 10-1 thru 10-37 | — |

A

NOTE

The owner/operator should always refer to all supplements, whether STC Supplements or Beech Supplements, for possible placards, limitations, normal, emergency and other operational procedures for proper operation of the airplane with optional equipment installed.

The following information may be provided to the holder of this manual automatically:

1. Original issues and revisions of Class I and Class II Service Instructions
2. Original issues and revisions of FAA Approved Airplane Flight Manual Supplements
3. Reissues and revisions of FAA Approved Airplane Flight Manuals, Flight Handbooks, Owner's Manuals, Pilot's Operating Manuals, and Pilot's Operating Handbooks

This service is free and will be provided only to airplane owners who are listed on the FAA Aircraft Registration Branch List or the BEECHCRAFT International Owners Notification Service List, and then only if listed by airplane serial number for the model for which this handbook is applicable. For detailed information on how to obtain "Revision Service" applicable to this handbook or other BEECHCRAFT Service Publications consult any BEECHCRAFT Aero or Aviation Center, International Distributor, or International Dealer, or refer to the latest revision of BEECHCRAFT Service Instructions No. 0250-010.

Due to the large variety of airplane configurations available through optional equipment, it should be noted that where information pertaining to optional equipment appears in the handbook, the optional equipment will not normally be designated as such. Due to custom design variations, the illustrations in this handbook will not be typical of every airplane.

Beech Aircraft Corporation expressly reserves the right to supersede, cancel, and/or declare obsolete, without prior notice, any part, part number, kit, or publication that may be referenced in this handbook.

REVISING THE HANDBOOK

Immediately following the Title Page is the "Log of Revisions" page(s). The Log of Revisions pages are used for maintaining a listing of all effective pages in the handbook (except the SUPPLEMENTS section), and as a record of revisions to these pages. In the lower right corner of the outlined portion is a box containing a capital letter which denotes the issue or reissue of the handbook. It will be advanced one letter, alphabetically, per reissue. This letter will be suffixed by a number whenever the handbook is revised. When a revision to the handbook is made, a new Log of Revisions will be issued. All Logs of Revisions must be retained in the handbook to provide a complete record of material status until a reissue is made.

WARNING

When this handbook is used for airplane operational purposes it is the pilot's responsibility to maintain it in current status.

**AIRPLANE FLIGHT MANUAL SUPPLEMENTS
REVISION RECORD**

Section IX contains the FAA Approved Airplane Flight Manual Supplements headed by a Log of Supplements page. On the "Log" page is a listing of the FAA Approved Supplemental Equipment available for installation on the airplane. When new supplements are received or existing supplements are revised, a new "Log" page will replace the previous one, since it contains a listing of all previous approvals, plus the new approval. The supplemental material will be added to the grouping in accordance with the descriptive listing.

NOTE

Upon receipt of a new or revised supplement, compare the "Log" page just received with the existing "Log" page in the manual. Retain the "Log" page with the latest date on the bottom of the page and discard the other log.

VENDOR-ISSUED STC SUPPLEMENTS

When a new airplane is delivered from the factory, the handbook delivered with it contains either an STC (Supplemental Type Certificate) Supplement or a Beech Flight Manual Supplement for every installed item requiring a supplement. If a new handbook for operation of the airplane is obtained at a later date, it is the responsibility of the owner/operator to ensure that all required STC Supplements (as well as weight and balance and other pertinent data) are transferred into the new handbook.

INTENTIONALLY LEFT BLANK

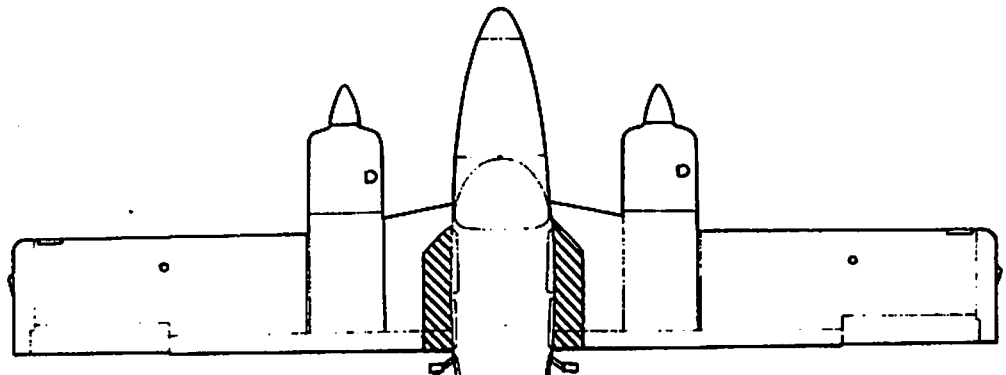

WING AREA: 181 SQ. FT.

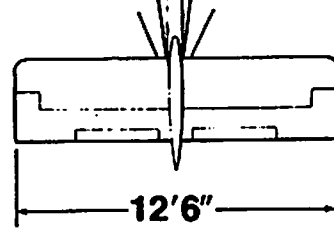

12'6"

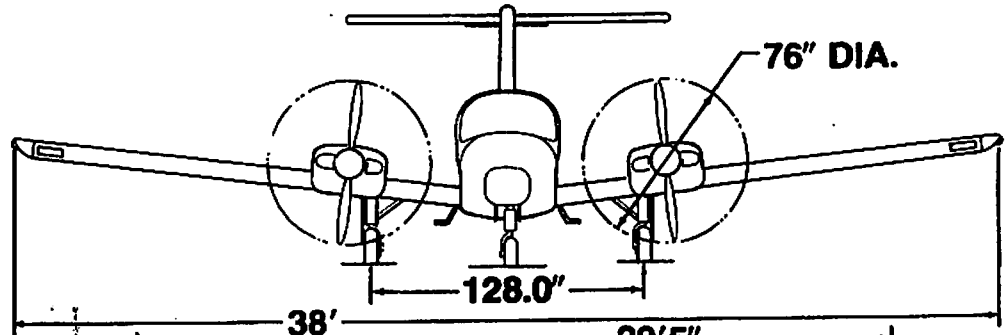

76" DIA.

38'

29'5"

128.0"

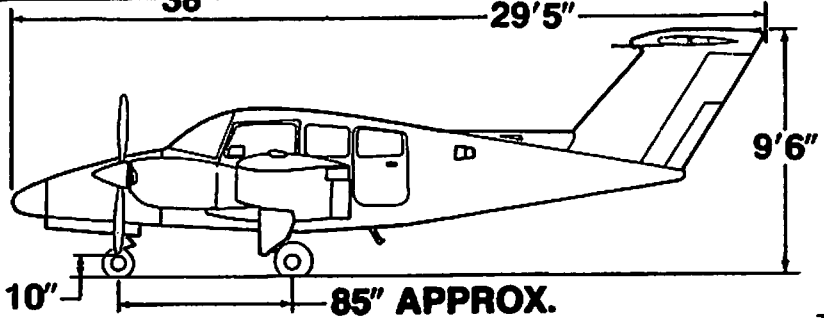

10"

85" APPROX.

9'6"

76-607-4

THREE-VIEW

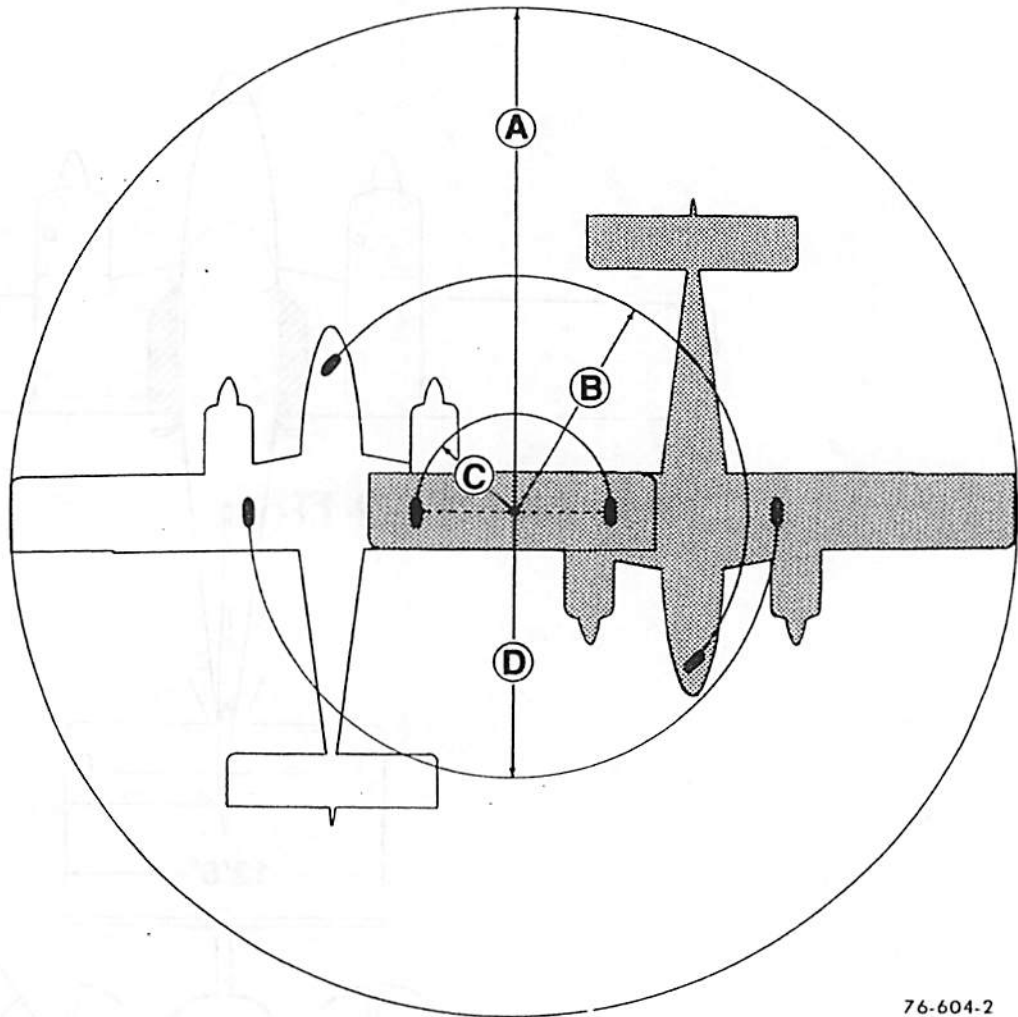

76-604-2

GROUND TURNING CLEARANCE

- (A) Radius for Wing Tip27 feet 2 inches
- (B) Radius for Nose Wheel9 feet 10 inches
- (C) Radius for Inside Gear3 feet 1 inch
- (D) Radius for Outside Gear 13 feet 8 inches

TURNING RADII ARE PREDICATED ON THE USE OF PARTIAL BRAKING ACTION AND DIFFERENTIAL POWER.

DESCRIPTIVE DATA

ENGINES

Two Avco Lycoming engines are installed; one O-360-A1G6D (clockwise rotating) located on the left wing, and one LO-360-A1G6D (counterclockwise rotating) located on the right wing. The engines are four-cylinder, direct-drive, horizontally opposed, and each rated at 180 horsepower at 2700 rpm.

Take-off and Maximum

Continuous Power Full throttle, 2700 rpm

Recommended Maximum

Cruise Power 24 in. Hg, 2700 rpm

PROPELLERS

The airplane is equipped with two Hartzell, constant-speed, full-feathering, two-blade propellers: the left engine (clockwise rotating) has an HC-M2YR-2CEUF hub with FC 7666A blades and a C2285-3P spinner; the right engine (counterclockwise rotating) incorporates an HC-M2YR-2CLEUF hub with FJC 7666A blades and a C2285-3LP spinner.

Pitch settings at the 30 inch station: Low, $12.1^\circ \pm .1^\circ$;
High, 17° to 20° ; Feathered, $81^\circ \pm 1^\circ$.

Diameter is 76 inches, with cut-off permitted to 74.0 inches.

FUEL

Aviation Gasoline, grade 100 (green) or grade 100 LL (blue).

Total Capacity 103 gallons
Total Usable 100 gallons

OIL

Engine oils must meet Avco Lycoming Specification No. 301F and be used in accordance with Avco Lycoming Service Instructions No. 1014J or subsequent revisions. Refer to HANDLING, SERVICING, AND MAINTENANCE section for a list of oils meeting this specification.

| Average Ambient Air Temperature | MIL-L-6082 Grades | MIL-L-22851 Ashless Dispersant Grades |
|---------------------------------|-------------------|---------------------------------------|
| Above 60°F | SAE 50 | SAE 40 or SAE 50 |
| 30° to 90°F | SAE 40 | SAE 40 |
| 0° to 70°F | SAE 30 | SAE 40, SAE 30 or SAE 20W40 |
| Below 10°F | SAE 20 | SAE 30 or SAE 20W30 |

Oil Capacity8 quarts each engine

MAXIMUM CERTIFICATED WEIGHTS

Maximum Ramp Weight 3916 lbs
Maximum Take-off Weight 3900 lbs
Maximum Landing Weight 3900 lbs
Maximum Zero Fuel Weight 3500 lbs
Maximum Weight in Baggage Compartment 200 lbs

STANDARD AIRPLANE WEIGHTS

| | |
|---------------------------------|----------|
| Standard Empty Weight | 2446 lbs |
| Maximum Useful Load | 1470 lbs |

CABIN AND ENTRY DIMENSIONS

| | |
|----------------------------------|-----------------|
| Cabin Width (maximum) | 3 ft 8 in. |
| Cabin Length (maximum) | 7 ft 11 in. |
| Cabin Height (maximum) | 4 ft |
| Cabin Door | 36 in. x 38 in. |
| Door Sill Height | 2 in. |

BAGGAGE SPACE AND ENTRY DIMENSIONS

| | |
|--|------------|
| Compartment Volume | 19.5 cu ft |
| Compartment Width (nominal) | 38 in. |
| Compartment Length (nominal) | 26 in. |
| Compartment Height (nominal) | 37 in. |
| Door Width (minimum) | 22 in. |
| Door Height (minimum) | 33 in. |

SPECIFIC LOADINGS

| | |
|--|----------------|
| Wing Loading at Maximum Take-off Weight | 21.5 lbs/sq ft |
| Power Loading at Maximum Take-off Weight | 10.8 lbs/hp |

SYMBOLS, ABBREVIATIONS, AND TERMINOLOGY

The following Abbreviations and Terminologies have been listed for convenience and ready interpretation where used within this handbook. Whenever possible, they have been categorized for ready reference.

AIRSPPEED TERMINOLOGY

- IAS** Indicated Airspeed is the speed of an airplane as shown on its airspeed indicator. As used within this handbook IAS assumes no instrument error.
- CAS** Calibrated Airspeed is the indicated airspeed of an airplane, corrected for position and instrument error. Calibrated airspeed is equal to true airspeed in standard atmosphere at sea level.
- TAS** True Airspeed is the airspeed of an airplane relative to undisturbed air which is the CAS corrected for altitude, temperature, and compressibility.
- GS** Ground Speed is the speed of an airplane relative to the ground.
- V_{MCA}** Air Minimum Control Speed is the minimum flight speed at which the airplane is directionally controllable as determined in accordance with Federal Aviation Regulations. The airplane certification conditions include one engine becoming inoperative and windmilling, a 5-degree bank towards the operative engine, take-off power on operative engine, landing gear up, flaps in take-off position, and most rearward C.G. For some conditions of weight and altitude, stall can be encountered at speeds above V_{MCA} as established by the certification procedure described above, in which event stall speed must be regarded as the limit of effective directional control.

V_{SSE}

The Intentional One-Engine-Inoperative Speed is a speed above both V_{MCA} and stall speed, selected to provide a margin of lateral and directional control when one engine is suddenly rendered inoperative. Intentional failing of one engine below this speed is not recommended.

V_A

Maneuvering Speed is the maximum speed at which application of full available aerodynamic control will not overstress the airplane.

V_F

Design Flap Speed is the highest speed permissible at which wing flaps may be actuated.

V_{FE}

Maximum Flap Extended Speed is the highest speed permissible with wing flaps in a prescribed extended position.

V_{LE}

Maximum Landing Gear Extended Speed is the maximum speed at which an airplane can be safely flown with the landing gear extended.

V_{LO}

Maximum Landing Gear Operating Speed is the maximum speed at which the landing gear can be safely extended or retracted.

V_{NE}

Never Exceed Speed is the speed limit that may not be exceeded at any time.

| | |
|----------|--|
| V_{NO} | Maximum Structural Cruising Speed is the speed that should not be exceeded except in smooth air and then only with caution. |
| V_S | Stalling Speed or the minimum steady flight speed at which the airplane is controllable. |
| V_{SO} | Stalling Speed or the minimum steady flight speed at which the airplane is controllable in the landing configuration. |
| V_X | Best Angle-of-Climb Speed is the airspeed which delivers the greatest gain of altitude in the shortest possible horizontal distance. |
| V_Y | Best Rate-Of-Climb Speed is the airspeed which delivers the greatest gain in altitude in the shortest possible time. |

METEOROLOGICAL TERMINOLOGY

| | |
|------------|---|
| ISA | International Standard Atmosphere in which: <ol style="list-style-type: none">(1) The air is a dry perfect gas;(2) The temperature at sea level is 15° Celsius (59° Fahrenheit);(3) The pressure at sea level is 29.92 in. Hg (1013.2 millibars);(4) The temperature gradient from sea level to the altitude at which the temperature is -56.5°C (-69.7°F) is -0.00198°C (-0.003566°F) per foot and zero above that altitude. |
|------------|---|

OAT Outside Air Temperature is the free air static temperature, obtained either from inflight temperature indications adjusted for instrument error and compressibility effects, or ground meteorological sources.

Indicated Pressure Altitude The number actually read from an altimeter when the barometric subscale has been set to 29.92 in. Hg (1013.2 millibars).

Pressure Altitude Altitude measured from standard sea level pressure (29.92 in. Hg) by a pressure or barometric altimeter. It is the indicated pressure altitude corrected for position and instrument error. In this handbook, altimeter instrument errors are assumed to be zero. Position errors may be obtained from the Altimeter Correction graph.

Station Pressure Actual atmospheric pressure at field elevation.

Wind The wind velocities recorded as variables on the charts of this handbook are to be understood as the headwind or tailwind components of the reported winds.

POWER TERMINOLOGY

Take-off and Maximum Continuous Highest power rating not limited by time.

Cruise Climb Power recommended for cruise climb.

**ENGINE CONTROLS AND INSTRUMENTS
TERMINOLOGY**

| | |
|--------------------|---|
| Throttle Control | The lever used to control power by introducing fuel-air mixture into the intake passages of the engine. Settings are reflected by readings on the manifold pressure gage. |
| Propeller Control | This lever requests the governor to maintain rpm at a selected value and, in the maximum decrease rpm position, feathers the propeller. |
| Mixture Control | This lever is used to set fuel flow in all modes of operation and cuts off fuel completely for engine shutdown. |
| Tachometer | Indicates the rotational speed of the engine/propeller in revolutions per minute (rpm). |
| Propeller Governor | Regulates the rpm of the engine/propeller by increasing or decreasing the propeller pitch through a pitch change mechanism in the propeller hub. |
| Manifold Pressure | An instrument that measures the absolute pressure in the intake manifold of an engine, expressed in inches of mercury (in. Hg). |
| EGT | The Exhaust Gas Temperature Indicator is used to identify the lean and best-power fuel flow mixtures for various power settings during cruise. |

**AIRPLANE PERFORMANCE AND FLIGHT
PLANNING TERMINOLOGY**

**Climb
Gradient**

The ratio of the change in height during a portion of a climb, to the horizontal distance traversed, in the same time interval.

**Demonstrated
Crosswind
Velocity**

The demonstrated crosswind velocity is the velocity of the crosswind component for which adequate control of the airplane during takeoff and landing was actually demonstrated during certification tests. The value shown is not limiting.

**Accelerate-
Stop Distance**

The distance required to accelerate an airplane to a specified speed and, assuming failure of an engine at the instant that speed is attained, to bring the airplane to a stop.

**Accelerate-
Go Distance**

The distance required to accelerate an airplane to a specified speed and, assuming failure of an engine at the instant that speed is attained, feather inoperative propeller and continue takeoff on the remaining engine to a height of 50 feet.

MEA

Minimum Enroute IFR Altitude.

**Route
Segment**

A part of a route. Each end of that part is identified by:

- (1) A geographical location; or
- (2) A point at which a definite radio fix can be established.

WEIGHT AND BALANCE TERMINOLOGY

| | |
|---------------------------------|--|
| Standard Empty Weight | Weight of a standard airplane including unusable fuel, full operating fluids, and full oil. |
| Basic Empty Weight | Standard empty weight plus optional equipment. |
| Usable Fuel | Fuel available for flight planning. |
| Unusable Fuel | Fuel remaining after a runout test has been completed in accordance with governmental regulations. |
| Payload | Weight of occupants, cargo, and baggage. |
| Useful Load | Difference between ramp weight and basic empty weight. |
| Maximum Ramp Weight | Maximum weight approved for ground maneuvering. (It includes weight of start, taxi, and run-up fuel.) |
| Maximum Take-Off Weight | Maximum weight approved for the start of the take-off run. |
| Maximum Landing Weight | Maximum weight approved for the landing touchdown. |
| Maximum Zero Fuel Weight | Maximum weight exclusive of usable fuel. |

| | |
|--|---|
| Loading Condition | That combination of airplane weight and corresponding moment applicable to the various loadings computed for weight and balance purposes. |
| Reference Datum | An imaginary vertical plane from which all horizontal distances are measured for balance purposes. |
| Station | A location along the airplane fuselage usually given in terms of distance from the reference datum. |
| Arm | The horizontal distance from the reference datum to the center of gravity (CG) of an item. |
| Moment | The product of the weight of an item multiplied by its arm. (Moment divided by a constant is used to simplify balance calculations by reducing the number of digits.) |
| Airplane Center of Gravity (CG) | The point at which an airplane would balance if suspended. Its distance from the reference datum is found by dividing the total moment by the total weight of the airplane. |
| CG Arm | The arm obtained by adding the airplane's individual moments and dividing the sum by the total weight. |
| CG Limits | The extreme center of gravity locations within which the airplane must be operated at a given weight. |

**Section I
General**

**BEECHCRAFT
Duchess 76**

- Tare** The apparent weight which may be indicated by a scales before any load is applied.
- Leveling
Points** Those points which are used during the weighing process to level the airplane.
- Jack Points** Points on the airplane identified by the manufacturer as suitable for supporting the airplane for weighing or other purposes.

LIMITATIONS

SECTION II

LIMITATIONS

TABLE OF CONTENTS

| <i>SUBJECT</i> | <i>PAGE</i> |
|--|-------------|
| Airspeed Limitations | 2-3 |
| Airspeed Indicator Markings | 2-4 |
| Power Plant Limitations | 2-4 |
| Engines | 2-4 |
| Fuel | 2-5 |
| Fuel Additives | 2-5 |
| Oil | 2-5 |
| Propellers | 2-5 |
| Power Plant Instrument Markings | 2-6 |
| Miscellaneous Instrument Markings | 2-6 |
| Weight Limits | 2-7 |
| Center of Gravity | 2-7 |
| Maneuvers | 2-7 |
| Flight Load Factors (3900 Pounds) | 2-8 |
| Minimum Flight Crew | 2-8 |
| Kinds of Operation | 2-8 |
| Fuel | 2-9 |
| Fuel Management | 2-9 |
| Seating | 2-9 |
| Structural Life | 2-9 |
| Required Equipment for Various Conditions of Flight | 2-10 |
| Placards | 2-21 |

INTENTIONALLY LEFT BLANK

The limitations included in this section have been approved by the Federal Aviation Administration.

The following limitations in this section must be observed in the operation of this airplane.

AIRSPEED LIMITATIONS

| SPEED | CAS KTS | IAS KTS | REMARKS |
|--|--------------------|--------------------|--|
| Never Exceed VNE | 194 | 194 | Do Not Exceed This Speed in Any Operation. |
| Maximum Structural Cruising VNO | 154 | 154 | Do Not Exceed This Speed Except in Smooth Air and Then Only With Caution. |
| Maneuvering VA | 132 | 132 | Do Not Make Full or Abrupt Control Movements Above This Speed. |
| Maximum Flap Extension/Extended VF and VFE (Full Down 35°) | 110 | 110 | Do Not Extend Flaps or Operate With Flaps Extended Above This Speed. |
| Maximum Landing Gear Extended VLE | 140 | 140 | Do Not Exceed This Speed With Landing Gear Extended. |
| Maximum Landing Gear Operating VLO Extension Retraction | 140 113 | 140 112 | Do Not Extend or Retract Landing Gear Above This Speed. |
| Air Minimum Control VMCA | 67 | 65 | Minimum Speed for Directional Controllability After Sudden Loss of Engine. |

***AIRSPEED INDICATOR MARKINGS**

| MARK- ING | CAS VALUE OR RANGE KTS | IAS VALUE OR RANGE KTS | SIGNIFICANCE |
|----------------------|---------------------------------------|---------------------------------------|---|
| White Arc | 58-110 | 60-110 | Full Flap Operating Range |
| Blue Radial | 86 | 85 | Single-Engine Best Rate- of-Climb |
| Red Radial | 67 | 65 | Minimum Single-Engine Control (VMCA) |
| Green Arc | 68-154 | 70-154 | Normal Operat- ing Range |
| Yellow Arc | 154-194 | 154-194 | Operate With Caution, Only In Smooth Air |
| Red Radial | 194 | 194 | Maximum Speed For All Operations (Never Exceed) |

*The airspeed indicator is marked in IAS values.

POWER PLANT LIMITATIONS

ENGINES

Two Avco Lycoming engines installed; one O-360-A1G6D (clockwise rotating) located on the left wing, and one LO-360-A1G6D (counterclockwise rotating) located on the right wing. The engines are four-cylinder, direct-drive, horizontally opposed, and each rated at 180 horsepower at 2700 rpm.

Take-off and Maximum

Continuous Power..... Full Throttle, 2700 RPM

Maximum Oil Temperature 245°F

Maximum Cylinder Head Temperature 500°F

POWER PLANT INSTRUMENT MARKINGS

Oil Temperature

Caution Range (Yellow Arc).....60 to 120°F
Normal Operating Range (Green Arc).....120 to 245°F
Maximum (Red Radial) 245°F

Oil Pressure

Minimum Idle (Red Radial)..... 25 psi
Caution Range (Yellow Arc).....25 to 60 psi
Normal Operating Range (Green Arc).....60 to 100 psi
Maximum (Red Radial) 100 psi

Manifold Pressure

Normal Operating Range (Green Arc)..... 15 to 29.6 in. Hg

Tachometer

Normal Operating Range
(Green Arc)2000 to 2700 rpm
Maximum (Red Radial)2700 rpm

Fuel Pressure

Minimum (Red Radial) 0.5 psi
Normal Operating Range (Green Arc).....0.5 to 8.0 psi
Maximum (Red Radial) 8.0 psi

Cylinder Head Temperature

Normal Operating Range (Green Arc).....200 to 500°F
Maximum (Red Radial) 500°F

MISCELLANEOUS INSTRUMENT MARKINGS

Instrument Pressure

Normal Operating Range (Green Arc)..... 4.3 to 5.9 in. Hg
Red Button Source Failure Indicators

| | |
|----------------------------------|---------|
| Minimum Oil Pressure (Idle)..... | 25 psi |
| Maximum Oil Pressure..... | 100 psi |
| Minimum Fuel Pressure..... | 0.5 psi |
| Maximum Fuel Pressure..... | 8.0 psi |

FUEL

Aviation Gasoline, grade 100 (green) or grade 100 LL (blue).

FUEL ADDITIVES

ALCOR TCP Concentrate, mixed according to the instructions provided by Alcor, Inc.

OIL

Engine oils must meet Avco Lycoming Specification No. 301F and be used in accordance with Avco Lycoming Service Instruction No. 1014J or subsequent revisions. Refer to the Approved Engine Oils, Section VIII, SERVICING.

PROPELLERS

Two Hartzell, constant-speed, full-feathering, two-blade propellers: the left engine (clockwise rotating) has an HC-M2YR-2CEUF hub with FC 7666A blades and C2285-3P spinner; the right engine (counterclockwise rotating) incorporates an HC-M2YR-2CLEUF hub with FJC 7666A blades and a C2285-3LP spinner.

Pitch settings at the 30-inch station: Low, $12.1^{\circ} \pm .1^{\circ}$;
High, 17° to 20° ; Feathered, $81^{\circ} \pm 1^{\circ}$.
Diameter is 76 inches, with cut-off permitted to 74.0 inches.

**BEECHCRAFT
Duchess 76**

**Section II
Limitations**

Fuel Quantity

Yellow Arc.....E to 9 Gallons

WEIGHT LIMITS

Maximum Ramp Weight..... 3916 lbs
Maximum Take-off Weight 3900 lbs
Maximum Landing Weight 3900 lbs
Zero Fuel Weight 3500 lbs
Maximum Baggage Compartment Load 200 lbs

CENTER OF GRAVITY (Landing Gear Extended)

Forward Limits: 106.6 inches aft of datum at 3250 lbs and under, then straight line variation to 110.6 inches aft of datum at a weight of 3900 lbs.

Aft Limit: 117.5 inches aft of datum at all weights.

Reference Datum: 129.37 inches forward of the center of wing spar jack points.

MAC Leading Edge: 99.08 inches aft of datum.

MAC Length: 57.65 inches.

MANEUVERS

This is a normal category airplane. Acrobatic maneuvers, including spins, are prohibited.

Maximum slip duration 30 seconds

**Section II
Limitations**

**BEECHCRAFT
Duchess 76**

FLIGHT LOAD FACTORS (3900 POUNDS)

Positive maneuvering load factors:

Flaps Up..... 3.8G
Flaps Down (DN)..... 2.0G

Negative maneuvering load factor:

Flaps Up..... - 1.52G

MINIMUM FLIGHT CREW..... One pilot

KINDS OF OPERATION

This airplane is approved for the following type operations when the required equipment is installed and operational as defined herein:

1. VFR day and night
2. IFR day and night
3. FAR 91 operations when all pertinent limitations and performance considerations are complied with.

WARNING

FLIGHT IN ICING CONDITIONS PROHIBITED.

FUEL

TOTAL FUEL with left and right wing fuel systems full:

Capacity..... 103 gallons*
Usable 100 gallons

*Value given is nominal. Tank capacity will vary with temperature, and manufacturing tolerances.

FUEL MANAGEMENT

Do not take off when Fuel Quantity indicators indicate in the yellow band on either indicator.

Maximum slip duration is 30 seconds.

The fuel crossfeed system to be used during emergency conditions in level flight only.

SEATING

All occupied seats must be in the upright position for takeoff and landing.

STRUCTURAL LIFE

The basic wing structure has a substantiated life of 20,000 flight hours provided the mandatory inspection requirements of chapter four of the BEECHCRAFT DUCHESS 76 MAINTENANCE MANUAL are complied with.

**REQUIRED EQUIPMENT FOR VARIOUS CONDITIONS OF
FLIGHT**

Part 91 of the Federal Aviation Regulations specifies minimum numbers and types of airplane instruments and equipment which must be installed and operated for various kinds of flight conditions. This includes VFR day, VFR night, IFR day and IFR night.

Regulations also require that all airplanes be certified by the manufacturer for operations under various flight conditions. At certification, all required equipment must be in operating condition and should be maintained to assure continued airworthiness. If deviations from the installed equipment were not permitted, or if the operating rules did not provide for various flight conditions, the airplane could not be flown unless all equipment were operable. With appropriate limitations, the operation of every system or component installed in the airplane is not necessary when the remaining operative instruments and equipment provide for continued safe operation. Operation in accordance with limitations established to maintain airworthiness can permit continued or uninterrupted operation of the airplane.

For the sake of brevity, the Required Equipment Listing does not include obviously required items such as wings, rudder, flaps, engines, landing gear, etc. Also the list does not include items which do not affect the airworthiness of the airplane such as entertainment systems, passenger convenience items, etc. However, it is important to note that **ALL ITEMS WHICH ARE RELATED TO THE AIRWORTHINESS OF THE AIRPLANE AND NOT INCLUDED ON THE LIST ARE AUTOMATICALLY REQUIRED TO BE OPERATIVE.**

To enable the pilot to rapidly determine the FAA equipment requirements necessary for a flight into specific conditions, the following equipment requirements and exceptions are presented. It is the final responsibility of the pilot to determine whether the lack of, or inoperative status of a piece of equipment on the airplane, will limit the conditions under which the pilot may operate the airplane.

LEGEND

Numbers refer to quantities required to be operative for a specified condition.

- (-) Indicates that the item may be inoperative for the specified condition.
- (*) Refers to the REMARKS AND/OR EXCEPTIONS column for explicit information or reference.

**Section II
Limitations**

**BEECHCRAFT
Duchess 76**

| SYSTEM and/or COMPONENT | VFR Day | | | VFR Night | | | IFR Day | | | IFR Night | | |
|-------------------------------------|---------|---|---|-----------|---|---|---------|---|---|-----------|---|--------------|
| | | | | | | | | | | | | |
| | | | | | | | | | | | | |
| GENERAL OVERWATER FLIGHT | * | * | * | * | * | * | * | * | * | * | * | * Per FAR 91 |
| COMMUNICATIONS | | | | | | | | | | | | |
| VHF communications system | * | * | * | * | * | * | * | * | * | * | * | * Per FAR 91 |
| ELECTRICAL POWER | | | | | | | | | | | | |
| Battery system | 1 | 1 | 1 | 1 | 1 | 1 | 1 | 1 | 1 | 1 | 1 | - |
| DC alternator | 2 | 2 | 2 | 2 | 2 | 2 | 2 | 2 | 2 | 2 | 2 | - |
| DC loadmeter | 2 | 2 | 2 | 2 | 2 | 2 | 2 | 2 | 2 | 2 | 2 | - |

| | | | | | |
|--|---|---|---|---|---|
| Alternator-out overvoltage indicator light | 2 | 2 | 2 | 2 | 2 |
| Alternator-out undervoltage indicator light | 2 | 2 | 2 | 2 | 2 |
| Starter Engaged Warning Light (ME-333, ME-346 and after) | 1 | 1 | 1 | 1 | 1 - May be inoperative provided loadmeters are operative and monitored. |
| EQUIPMENT AND FURNISHINGS | | | | | |
| Seat belts and shoulder harnesses | 1 | 1 | 1 | 1 | 1 - Per Person or Per FAR 91 |
| Emergency locator transmitter | 1 | 1 | 1 | 1 | 1 - Per FAR 91 |
| FIRE PROTECTION | | | | | |
| Portable fire extinguisher | * | * | * | * | *Optional |

| SYSTEM and/or COMPONENT | VFR Day | | VFR Night | | IFR Day | | IFR Night | | Remarks and/or Exceptions |
|---------------------------------------|---------|---|-----------|---|---------|---|-----------|---|---|
| | | | | | | | | | |
| FLIGHT CONTROLS | | | | | | | | | |
| Trim tab indicators - Rudder Elevator | 1 | 1 | 1 | 1 | 1 | 1 | 1 | 1 | May be inoperative provided that tabs are visually checked in the neutral position prior to each takeoff and checked for full range of operation. |
| Flap position indicator | 1 | 1 | 1 | 1 | 1 | 1 | 1 | 1 | May be inoperative provided flap travel is visually inspected prior to takeoff. |
| Stall warning system | 1 | 1 | 1 | 1 | 1 | 1 | 1 | 1 | |

| | | | | | | |
|-----------------------------------|---|---|---|---|---|--|
| FUEL EQUIPMENT | | | | | | |
| Engine driven fuel pump | 2 | 2 | 2 | 2 | 2 | 2 |
| Electrically driven aux fuel pump | 2 | 2 | 2 | 2 | 2 | 2 |
| Fuel quantity indicator | 2 | 2 | 2 | 2 | 2 | 2 |
| | | | | | | One may be inoperative provided other side is operational and amount of fuel on board can be established to be adequate for the intended flight. |
| Fuel pressure indicator | 2 | 2 | 2 | 2 | 2 | 2 |
| ICE AND RAIN PROTECTION | | | | | | |
| Alternate static air source | 1 | 1 | 1 | 1 | 1 | 1 |
| Pitot heater | - | - | - | - | - | - |

**Section II
Limitations**

**BEECHCRAFT
Duchess 76**

| SYSTEM and/or COMPONENT | VFR Day | | | | Remarks and/or Exceptions |
|-------------------------------|-----------|---------|-----------|---------|---------------------------|
| | VFR Night | | IFR Day | | |
| | IFR Night | IFR Day | IFR Night | IFR Day | |
| LANDING GEAR | | | | | |
| Landing gear motor | 1 | 1 | 1 | 1 | |
| Landing gear position lights | 4 | 4 | 4 | 4 | |
| Landing gear warning horn | 1 | 1 | 1 | 1 | |
| LIGHTS | | | | | |
| Cockpit and instrument lights | - | * | - | * | *Lights must be operative |
| Taxi Light (2) | - | - | - | - | |

| | | | | | | |
|-------------------------------|---|---|---|---|---|-------------|
| Landing light (1) | - | * | - | * | - | *Per FAR 91 |
| Strobe light | * | 2 | * | 2 | - | *Optional |
| Position light | - | 3 | - | 3 | - | |
| NAVIGATION INSTRUMENTS | | | | | | |
| Altimeter | 1 | 1 | 1 | 1 | - | |
| Airspeed indicator | 1 | 1 | 1 | 1 | - | |
| Vertical speed | - | - | - | - | - | |
| Magnetic compass | 1 | 1 | 1 | 1 | - | |
| Attitude indicator | - | - | 1 | 1 | - | |
| Turn and slip indicator | - | - | 1 | 1 | - | |
| Directional gyro | - | - | 1 | 1 | - | |
| Clock | - | - | 1 | 1 | - | |
| Transponder | * | * | * | * | - | *Per FAR 91 |
| Navigation equipment | - | - | * | * | - | *Per FAR 91 |

**Section II
Limitations**

**BEECHCRAFT
Duchess 76**

| SYSTEM and/or COMPONENT | VFR Day | | | | Remarks and/or Exceptions |
|--------------------------------------|-----------|---------|-----------|---------|---------------------------|
| | VFR Night | | IFR Day | | |
| | IFR Night | IFR Day | IFR Night | IFR Day | |
| PNEUMATIC | | | | | |
| Pressure system for instrument air | - | 1 | 1 | - | |
| Pressure gage | - | 1 | 1 | - | |
| ENGINE INDICATING INSTRUMENTS | | | | | |
| Engine tachometer indicator | 2 | 2 | 2 | - | |
| Exhaust gas temperature indicator | * | * | * | - | *Optional |

| | | |
|-------------------------------------|---|---|
| Manifold pressure indicator | 2 | - |
| Cylinder head temperature indicator | 2 | - |
| ENGINE OIL INSTRUMENTS | | |
| Oil pressure indicator | 2 | 2 |
| Oil temperature indicator | 2 | 2 |

INTENTIONALLY LEFT BLANK

PLACARDS

On Left Cabin Door (ME-1 thru ME-282, ME-284 thru ME-286) or On Left Cabin Sidewall (ME-283, ME-287 and after):



OPERATION LIMITATIONS

THIS AIRPLANE MUST BE OPERATED AS A NORMAL CATEGORY AIRPLANE IN COMPLIANCE WITH THE OPERATING LIMITATION STATED IN THE FORM OF PLACARDS, MARKINGS AND MANUALS. MAXIMUM WEIGHT IS 3900 LBS. THIS AIRPLANE APPROVED FOR VFR, IFR, DAY AND NIGHT NON-ICING FLIGHT WHEN EQUIPPED IN ACCORDANCE WITH FAR 91 OR FAR 135.

NO ACROBATIC MANEUVERS INCLUDING SPINS APPROVED.

WARNING — TURN OFF STROBE LIGHTS WHEN TAXIING IN VICINITY OF OTHER AIRCRAFT OR DURING FLIGHT THROUGH CLOUD, FOG OR HAZE.

AIRSPEEDS

NEVER EXCEED ----- 194 KNOTS

MAX. STRUCTURAL CRUISE ----- 154 KNOTS

MAX. MANEUVERING ----- 132 KNOTS

MAX. FLAPS 20° ----- 120 KNOTS

MAX. FULL DOWN FLAPS 35° ----- 110 KNOTS

MAX. LANDING GEAR EXTENSION ----- 140 KNOTS

MAX. LANDING GEAR RETRACTION ----- 113 KNOTS

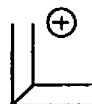

ALTITUDE LOST IN ONE ENGINE INOP STALL -----150 FEET & 10° PITCH DOWN

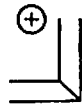

Lower Sidewall Adjacent to Pilot:



WARNING

ALTERNATE STATIC AIR SOURCE

**ON
ALTERNATE**

**SEE PERFORMANCE
SECTION OF PILOTS
OPERATING HANDBOOK
FOR AIRSPEED & ALTIMETER
CALIBRATION ERROR**



**OFF
NORMAL**



PLACARDS (Cont'd)

On Left Cabin Door:



On Floorboard in Front of Pilot's Seat:

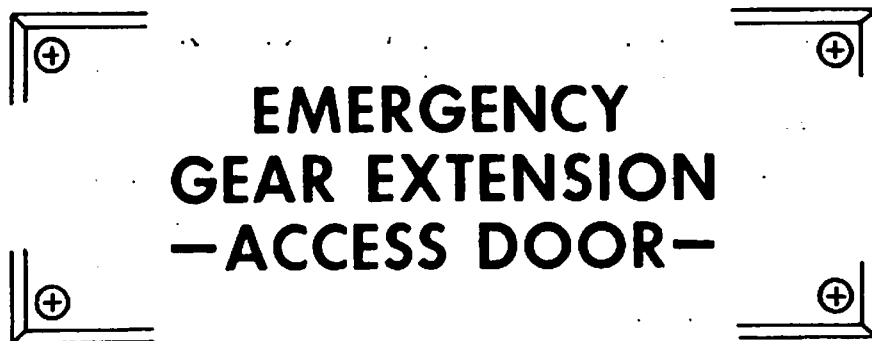

On Inside of Emergency Gear Extension Access Door:



1. Landing Gear Motor Circuit Breaker - OFF (Pull)
2. Gear Position Switch - DOWN
3. Maximum Indicated Airspeed - 100 KNOTS



On Lower Left Sidewall Panel:

**TO LEVEL AIRCRAFT – LEVEL
BAGGAGE COMPARTMENT FLOOR**

On Left Side Panel:

**DEFROST
PULL ON**

**CABIN AIR
PULL OFF**

**CABIN HEAT
PULL INCREASE**

On Aft Cabin Bulkhead:

**HAT SHELF
NO HEAVY OBJECTS**

PLACARDS (Cont'd)

On Fuel Selector Panel:

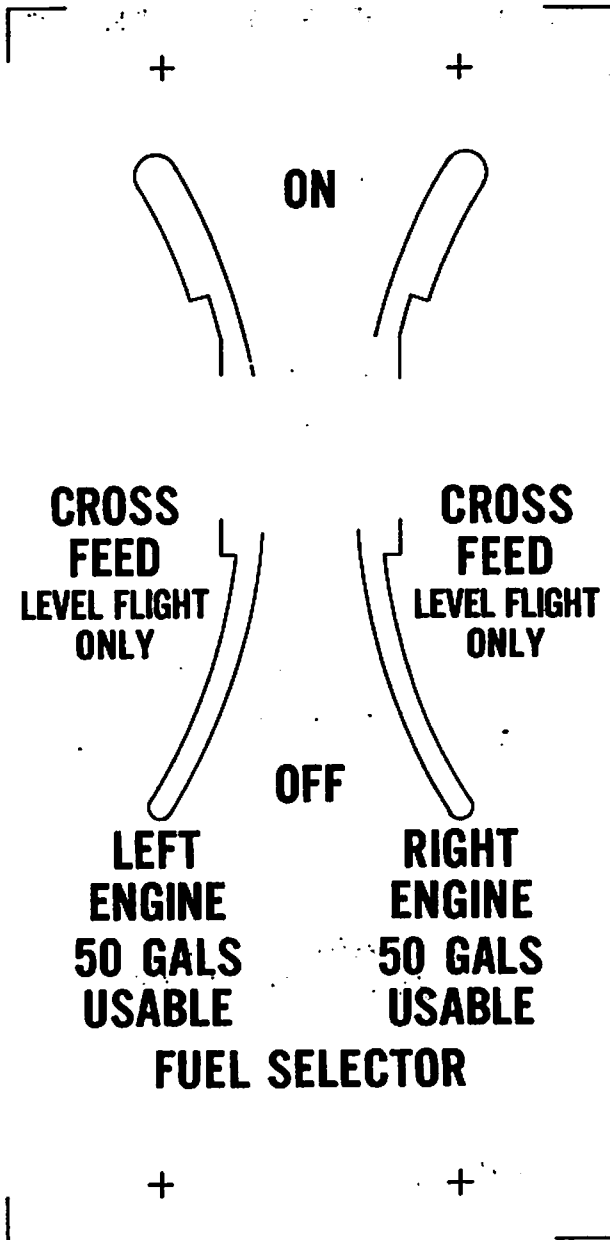

**BEECHCRAFT
Duchess 76**

**Section II
Limitations**

On Pedestal :

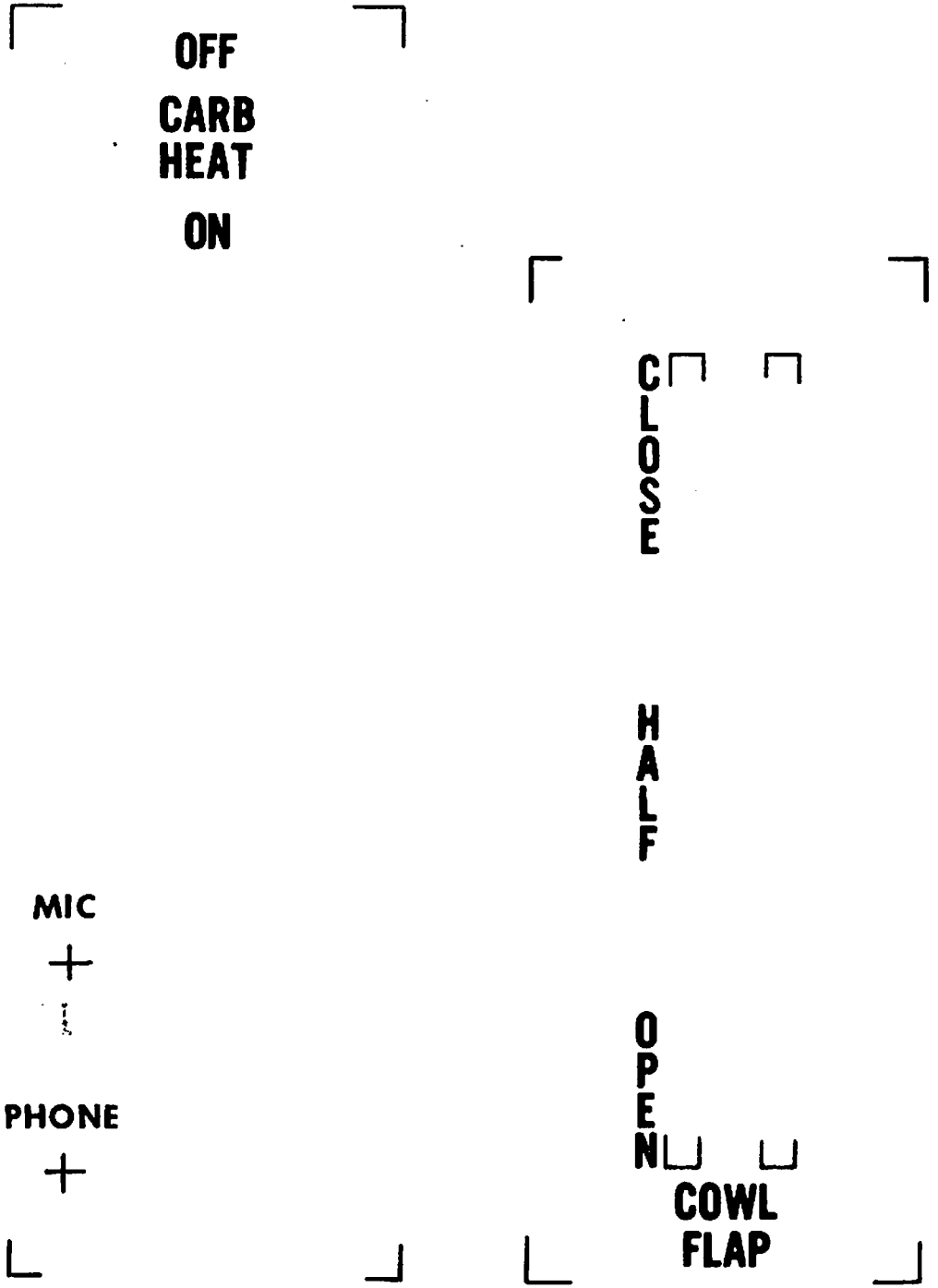

PLACARDS (Cont'd)

On Pedestal Between Front Seats:

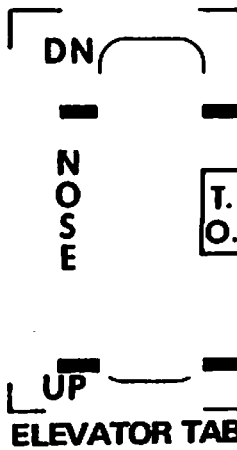
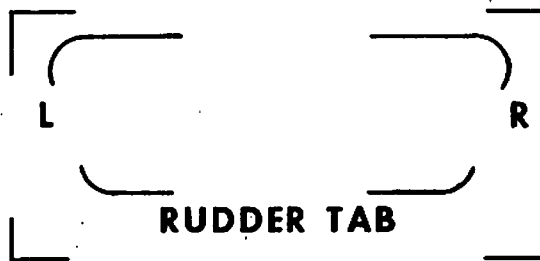
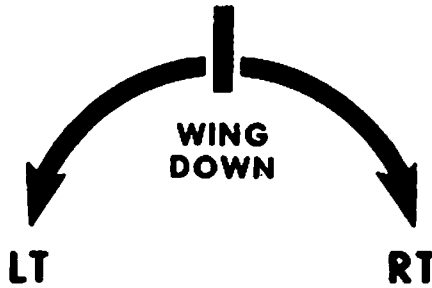

Adjacent to Each Seat:

INSTRUCTION-SHOULDER STRAP

- 1. OCCUPANTS SHORTER THAN
4 FT. 7 IN. **DO NOT** USE
SHOULDER STRAP.**
- 2. PLACE SEAT BACK IN THE
UPRIGHT POSITION DURING
TAKEOFF AND LANDING.**

On Baggage Door Adjacent to Handle:

**PULL PIN
ROTATE
HANDLE
TO OPEN**



On Baggage Compartment Door:

BAGGAGE COMPARTMENT

**LOAD IN ACCORDANCE
WITH WEIGHT AND BALANCE
INSTRUCTION**

**MAXIMUM STRUCTURAL
CAPACITY - 200 POUNDS**

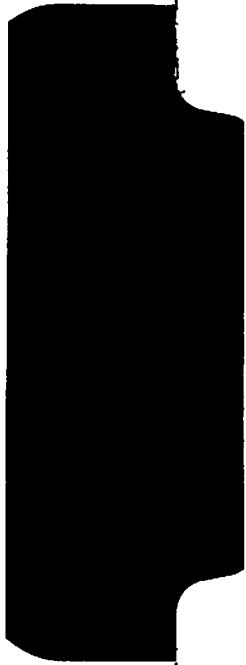



SECTION III

EMERGENCY PROCEDURES

TABLE OF CONTENTS

| <i>SUBJECT</i> | <i>PAGE</i> |
|---|-------------|
| Emergency Airspeeds (3900 lbs) | 3-3 |
| One-engine Operation | 3-3 |
| Determining Inoperative Engine | 3-4 |
| One-engine-inoperative Procedures | 3-4 |
| Engine Failure During Ground Roll | 3-4 |
| Engine Failure After Lift-off and in Flight | 3-5 |
| Air Start | 3-6 |
| Engine Fire (Ground) | 3-8 |
| Engine Fire in Flight | 3-8 |
| Emergency Descent | 3-8 |
| Maximum Glide Configuration | 3-8 |
| Landing Emergencies | 3-9 |
| Gear-up Landing | 3-9 |
| One-engine-inoperative Landing | 3-9 |
| One-engine-inoperative Go-Around | 3-10 |
| Systems Emergencies | 3-10 |
| Operation on Crossfeed | 3-10 |
| Electrical Smoke or Fire | 3-11 |
| Complete Loss of Electrical Power | 3-12 |
| Illumination of Alternator-Out Light | 3-12A |
| Starter Engaged Warning Light Illuminated | 3-12B |
| Unscheduled Electric Elevator Trim | 3-12B |
| Landing Gear Manual Extension | 3-13 |
| Landing Gear Retraction After | |
| Practice Manual Extension | 3-13 |
| Alternate Static Air Source | 3-14 |
| Emergency Exit | 3-15 |

TABLE OF CONTENTS (Continued)

| <i>SUBJECT</i> | <i>PAGE</i> |
|--|-------------|
| Simulated One-Engine Inoperative | 3-15 |
| Unlatched Door in Flight | 3-15 |
| Spins | 3-16 |

All airspeeds quoted in this section are indicated airspeeds (IAS) and assume zero instrument error.

EMERGENCY AIRSPEEDS (3900 LBS)

| | |
|---|---------|
| One-Engine-Inoperative Best | |
| Angle-of-Climb (V_X) | 85 kts |
| One-Engine-Inoperative Best | |
| Rate-of-Climb (V_Y) | 85 kts |
| Air Minimum Control Speed (V_{MCA}) | 65 kts |
| One-Engine-Inoperative | |
| Enroute Climb | 85 kts |
| Emergency Descent | 140 kts |
| One-Engine-Inoperative Landing: | |
| Maneuvering to Final Approach | 90 kts |
| Final Approach (Flaps Down) | 85 kts |
| Intentional One-Engine-Inoperative | |
| Speed (V_{SSE}) | 71 kts |
| Maximum Glide Range | 95 kts |

Stall warning horn is inoperative when the Battery and Alternator Switches are turned off.

The following information is presented to enable the pilot to form, in advance, a definite plan of action for coping with the most probable emergency situations which could occur in the operation of the airplane. Where practicable, the emergencies requiring immediate corrective action are treated in check list form for easy reference and familiarization. Other situations, in which more time is usually permitted to decide on and execute a plan of action, are discussed at some length.

ONE-ENGINE OPERATION

Two major factors govern one engine operations; airspeed and directional control. The airplane can be safely maneuvered or trimmed for normal hands-off operation and sustained in this configuration by the operative engine AS LONG AS SUFFICIENT AIRSPEED IS MAINTAINED.

DETERMINING INOPERATIVE ENGINE

The following checks will help determine which engine has failed:

1. **DEAD FOOT - DEAD ENGINE.** The rudder pressure required to maintain directional control will be on the side of the operative engine.
2. **THROTTLE.** Partially retard the throttle for the engine that is believed to be inoperative; there should be no change in control pressures or in the sound of the engine if the correct throttle has been selected. **AT LOW ALTITUDE AND AIRSPEED THIS CHECK MUST BE ACCOMPLISHED WITH EXTREME CAUTION.**

Do not attempt to determine the inoperative engine by means of the tachometers or the manifold pressure gages. These instruments often indicate near normal readings.

ONE-ENGINE-INOPERATIVE PROCEDURES

ENGINE FAILURE DURING GROUND ROLL

1. **Throttles - IDLE**
2. **Braking - MAXIMUM**
3. **Fuel Selectors - OFF**
4. **Battery, Alternator, and Magneto/Start Switches - OFF**

NOTE

Braking effectiveness is improved if the brakes are not locked.

ENGINE FAILURE AFTER LIFT-OFF AND IN FLIGHT

An immediate landing is advisable regardless of take-off weight. Continued flight can not be assured if take-off weight exceeds the weight determined from the TAKE-OFF WEIGHT graph. Higher take-off weights will result in a loss of altitude while retracting the landing gear and feathering the propeller. Continued flight requires immediate pilot response to the following procedures:

1. Landing Gear and Flaps - UP
2. Throttle (inoperative engine) - IDLE
3. Propeller (inoperative engine) - FEATHER
4. Power (operative engine) - AS REQUIRED
5. Airspeed - AT OR ABOVE THE 50-FT TAKE-OFF SPEED (80 KNOTS)

After positive control of the airplane is established:

6. Secure inoperative engine:
 - a. Mixture Control - IDLE CUT-OFF
 - b. Fuel Selector - OFF
 - c. Aux Fuel Pump - OFF
 - d. Magneto/Start Switch - OFF
 - e. Alternator Switch - OFF
 - f. Cowl Flap - CLOSE
7. Airspeed - ESTABLISH 85 KTS
8. Electrical Load - MONITOR (Maximum load of 100% on remaining engine)

NOTE

The most important aspect of engine failure is the necessity to maintain lateral and directional control. If airspeed is below 65 knots, reduce power on operative engine as required to maintain control. Refer to the SAFETY INFORMATION section for additional information regarding pilot technique.

AIR START

CAUTION

The pilot should determine the reason for engine failure before attempting an air start.

NOTE

Airspeed should be maintained at or above 100 KIAS to ensure the engine will windmill.

WITH UNFEATHERING ACCUMULATORS:

1. Fuel Selector - ON
2. Throttle - SET approximately ¼ travel
3. Aux Fuel Pump - ON
4. Magneto/Start Switch - BOTH
5. Propeller Control - MOVE FULL FORWARD UNTIL ENGINE WINDMILLS, THEN BACK TO MIDRANGE. USE STARTER MOMENTARILY IF AIRSPEED IS BELOW 100 KTS.

If propeller does not unfeather or engine does not turn, proceed to WITHOUT UNFEATHERING ACCUMULATORS procedure.

6. Mixture - FULL RICH
7. If engine fails to run, clear engine by allowing it to windmill with mixture in the FULL LEAN position. When engine fires, advance mixture to FULL RICH.
8. When Engine Starts - ADJUST THROTTLE, PROPELLER, AND MIXTURE CONTROLS
9. Aux Fuel Pump - OFF (when reliable power has been regained)
10. Alternator Switch - ON
11. Oil Pressure and Oil Temperature - CHECK
12. Warm Up Engine (approximately 2000 rpm and 15 in. HG)
13. Set power as required and trim.

WITHOUT UNFEATHERING ACCUMULATORS:

CAUTION

Numerous air starts without unfeathering accumulators can shorten engine-mount life.

1. Fuel Selector - ON
2. Throttle - SET approximately ¼ travel
3. Aux Fuel Pump - ON
4. Magneto/Start Switch - BOTH
5. Mixture - FULL RICH
6. Propeller Control - MOVE FORWARD OF FEATHERING DETENT TO MIDRANGE
7. Magneto/Start Switch - START and PUSH TO PRIME (hold on START until windmilling begins and continue to prime as required)

NOTE

If air start is unsuccessful, return propeller control to the FEATHER position and secure engine.

8. When Engine Starts - ADJUST THROTTLE, PROPELLER, AND MIXTURE CONTROLS
9. Aux Fuel Pump - OFF (when reliable power has been regained)
10. Alternator Switch - ON
11. Oil Pressure and Oil Temperature - CHECK
12. Warm Up Engine (approximately 2000 rpm and 15 in. Hg)
13. Set power as required and trim.

ENGINE FIRE (GROUND)

1. Mixture Controls - IDLE CUT-OFF
2. Continue to crank affected engine
3. Fuel Selectors - OFF
4. Battery and Alternator Switches - OFF
5. Extinguish fire with extinguisher

ENGINE FIRE IN FLIGHT

Shut down the affected engine according to the following procedure and land immediately. Follow the applicable single-engine procedures in this section.

1. Fuel Selector - OFF
2. Mixture Control - IDLE CUT-OFF
3. Propeller - FEATHER
4. Aux Fuel Pump - OFF
5. Magneto/Start Switch - OFF
6. Alternator Switch - OFF

EMERGENCY DESCENT

1. Propellers - 2700 RPM
2. Throttles - IDLE
3. Airspeed - 140 KTS
4. Landing Gear - DOWN

MAXIMUM GLIDE CONFIGURATION

1. Propellers - FEATHER
2. Wing Flaps - UP
3. Landing Gear - UP
4. Cowl Flaps - CLOSE
5. Airspeed - 95 KTS

The glide ratio in this configuration is approximately 2 nautical miles of gliding distance for each 1000 feet of altitude above the terrain.

LANDING EMERGENCIES

GEAR-UP LANDING

If possible, choose firm sod or foamed runway. When assured of reaching the landing site:

1. Cowl Flaps - CLOSE
2. Wing Flaps - FULL DOWN (DN)
3. Throttles - IDLE
4. Mixture Controls - IDLE CUT-OFF
5. Battery, Alternator, and Magneto/Start Switches - OFF
6. Fuel Selectors - OFF
7. Keep wings level during touchdown.
8. Get clear of the airplane as soon as possible after it stops.

NOTE

The gear-up landing procedures are based on the best available information and no actual tests have been conducted.

ONE-ENGINE-INOPERATIVE LANDING

On final approach and when it is certain that the field can be reached:

1. Landing Gear - DOWN
2. Airspeed - 85 KTS
3. Power - AS REQUIRED

When it is certain there is no possibility of go-around:

4. Wing Flaps - FULL DOWN (DN)
5. Execute normal landing.

ONE-ENGINE-INOPERATIVE GO-AROUND

WARNING

Level flight may not be possible for certain combinations of weight, temperature and altitude. In any event, **DO NOT** attempt a one-engine inoperative go-around after flaps have been fully extended.

1. Power - MAXIMUM ALLOWABLE
2. Landing Gear - UP
3. Wing Flaps - UP
4. Airspeed - MAINTAIN 85 KTS MINIMUM

SYSTEMS EMERGENCIES

OPERATION ON CROSSFEED

NOTE

The fuel crossfeed system is to be used during emergency conditions in level flight only.

Left Engine Inoperative:

1. Right Aux Fuel Pump - ON
2. Left Fuel Selector - OFF
3. Right Fuel Selector - CROSSFEED
4. Right Aux Fuel Pump - ON or OFF as required

Right Engine Inoperative:

1. Left Aux Fuel Pump - ON
2. Right Fuel Selector - OFF
3. Left Fuel Selector - CROSSFEED
4. Left Aux Fuel Pump - ON or OFF as required

ELECTRICAL SMOKE OR FIRE

Action to be taken must consider existing conditions and equipment installed:

1. Battery and Alternator Switches - OFF

WARNING

Electrically driven instruments and stall warning horn will become inoperative.

2. All Electrical Switches - OFF
3. Battery and Alternator Switches - ON
4. Essential Electrical Equipment - ON (Isolate defective equipment)

NOTE

Ensure fire is out and will not be aggravated by draft. Turn off CABIN HEAT switch and push in the CABIN AIR control. To aid in smoke evacuation, open pilot's storm window if required.

COMPLETE LOSS OF ELECTRICAL POWER

INDICATIONS

1. Dimming of lights, with loadmeters showing 100% or much greater than normal, or loadmeters showing 0% accompanied by no ALTERNATOR-OUT Lights.

ACTION

1. Both Alternator Switches - OFF
2. Battery Switch - OFF
3. Both BUS-ISO Circuit Breakers - PULL
4. Remove all electrical loads.
5. Both Alternator Switches - ON.
6. Minimize all electrical loads. Select only that electrical equipment which is essential for safe flight.
7. Extend landing gear with emergency system.
8. LAND AS SOON AS PRACTICAL; HAVE THE COMPLETE ELECTRICAL SYSTEM CHECKED BEFORE THE NEXT FLIGHT.

CAUTION

Since the battery is off line when this procedure is used, large changes in electrical load should be minimized in order to reduce the possibility of damage to electrical components.

ILLUMINATION OF ALTERNATOR-OUT LIGHT

In the event of the illumination of a single ALTERNATOR-OUT UNDERVOLTAGE light or a single ALTERNATOR-OUT OVERVOLTAGE light:

Check the respective loadmeter for load indication:

- a. No Load - Turn off affected alternator.
- b. Reduce load to single alternator capability.
- c. Reset the affected alternator with the alternator switch. Monitor overvoltage and undervoltage lights and loadmeter for proper operation.

CAUTION

If proper operation is not restored, turn alternator switch OFF.

In the event of the illumination of both ALTERNATOR-OUT UNDERVOLTAGE lights or both ALTERNATOR-OUT OVERVOLTAGE lights:

Check loadmeters for load indication. If condition indicates malfunction of both alternator circuits:

- a. Both ALT Switches - OFF
- b. Minimize electrical load since only battery power will be available.
- c. Reset the alternators with the alternator switches. Monitor overvoltage and undervoltage lights and loadmeters for proper operation.

CAUTION

If proper operation is not restored, turn alternator switches OFF.

**STARTER ENGAGED WARNING LIGHT ILLUMINATED
(If installed)**

After engine start, should the starter relay remain engaged, the starter will remain energized and the starter engaged warning light will remain illuminated. Continuing to supply power to the starter will result in eventual loss of electrical power.

Illuminated On the Ground:

1. Battery and Alternator Switches - OFF
2. Do not take off

Illuminated In Flight After Air Start:

1. Perform action for COMPLETE LOSS OF ELECTRICAL POWER (see this section)
2. Land as soon as practical

UNSCHEDULED ELECTRIC ELEVATOR TRIM

1. Airplane Attitude - MAINTAIN using elevator control.
2. Elevator Trim Thumb Switch (on control wheel) - DEPRESS AND MOVE IN DIRECTION OPPOSITE UNSCHEDULED PITCH TRIM.
3. Elevator Trim ON-OFF Switch (on instrument panel) - OFF
4. Manual Elevator Trim Control Wheel - RETRIM AS DESIRED

NOTE

Do not attempt to operate the electric trim system until the cause of the malfunction has been determined and corrected.

LANDING GEAR MANUAL EXTENSION

Reduce airspeed before attempting manual extension of the landing gear.

1. Landing GEAR MOTOR Circuit Breaker - OFF (pull out)
2. Landing Gear Switch Handle - DOWN position
3. Airspeed - 100 KTS MAXIMUM
4. Emergency Extension Valve - OPEN (Use Emergency Extension Wrench - Turn Counterclockwise)
5. If electrical system is operative, check landing gear position lights and warning horn. (Check Landing GEAR CONTROL circuit breaker engaged.)

WARNING

After emergency landing gear extension, do not move any landing gear controls or reset any switches or circuit breakers until airplane is on jacks, as failure may have been in the gear-up circuit and gear might retract with the airplane on the ground.

LANDING GEAR RETRACTION AFTER PRACTICE MANUAL EXTENSION

After practice manual extension of the landing gear, the gear can only be retracted electrically, as follows:

CAUTION

Do not operate landing gear electrically, or turn on landing light or taxi light, if battery is off the line.

1. Emergency Extension Valve - CLOSE (Use Emergency Extension Wrench - Turn Clockwise)
2. Landing GEAR MOTOR Circuit Breaker - ON (push in)
3. Landing Gear Switch Handle - UP

ALTERNATE STATIC AIR SOURCE

THE ALTERNATE STATIC AIR SOURCE SHOULD BE USED FOR CONDITIONS WHERE THE NORMAL STATIC SOURCE HAS BEEN OBSTRUCTED. When the airplane has been exposed to moisture and/or icing conditions (especially on the ground), the possibility of obstructed static ports should be considered. Partial obstruction will result in the rate-of-climb indication being sluggish during a climb or descent. Verification of suspected obstruction is possible by switching to the alternate system and noting a sudden sustained change in rate of climb. This may be accompanied by abnormal indicated airspeed and altitude changes beyond normal calibration differences.

Whenever any obstruction exists in the Normal Static Air System, or the Alternate Static Air System is desired for use:

1. Pilot's Alternate Static Air Source - Switch to ON ALTERNATE (lower sidewall adjacent to pilot)
2. For Airspeed Calibration and Altimeter Correction, refer to PERFORMANCE section.

NOTE

The alternate static air valve should remain in the OFF NORMAL position when system is not needed.

EMERGENCY EXIT

The forward cabin doors and/or the aft utility door may be used for egress if required.

SIMULATED ONE-ENGINE INOPERATIVE

ZERO THRUST (Simulated Feather)

Use the following power setting (only on one engine at a time) to establish zero thrust. Use of this power setting avoids the difficulties of restarting an engine and preserves the availability of power to counter potential hazards.

1. Throttle Lever - SET 8.0 in. Hg MANIFOLD PRESSURE
2. Propeller Lever - RETARD TO FEATHER DETENT

NOTE

This setting will approximate Zero Thrust using recommended one-engine-inoperative climb speeds.

UNLATCHED DOOR IN FLIGHT

If the cabin door is not secured it may come unlatched in flight. This usually occurs during or just after takeoff. The door will trail in a position approximately 3 inches open. A buffet may be encountered with the door open in flight. Return to the field in a normal manner. If practicable, during the landing flare-out have a passenger hold the door to prevent it from swinging open.

SPINS

If a Spin is Entered Inadvertently:

Immediately move the control column full forward, apply full rudder opposite to the direction of the spin and reduce power on both engines to idle. These three actions should be done as nearly simultaneously as possible; then continue to hold this control position until rotation stops and then neutralize all controls and execute a smooth pullout. Ailerons should be neutral during recovery.

NOTE

Federal Aviation Administration Regulations do not require spin demonstration of airplanes of this class; therefore, no spin tests have been conducted. The recovery technique is based on the best available information.

NORMAL PROCEDURES

SECTION IV

NORMAL PROCEDURES

TABLE OF CONTENTS

| <i>SUBJECT</i> | <i>PAGE</i> |
|---|-------------|
| Speeds for Safe Operation (3900 lbs) | 4-3 |
| Preflight Inspection | 4-3 |
| Before Starting..... | 4-7 |
| External Power | 4-7 |
| Starting Engines Using Auxiliary Power Unit..... | 4-8 |
| Starting | 4-9 |
| After Starting, and Taxi | 4-10A |
| Before Takeoff | 4-10B |
| Takeoff..... | 4-11 |
| Climb | 4-12 |
| Cruise | 4-12 |
| Leaning Mixture Using EGT Indicator | 4-13 |
| Descent | 4-13 |
| Before Landing | 4-13 |
| Balked Landing | 4-14 |
| After Landing | 4-14 |
| Shutdown..... | 4-15 |
| Environmental Systems..... | 4-15 |
| Heating and Ventilation | 4-15 |
| Electric Elevator Trim..... | 4-15 |
| Cold Weather Operation | 4-16 |
| Preflight Inspection..... | 4-16 |
| Engines | 4-16 |
| Taxiing | 4-17 |
| Practice Demonstration of VMCA | 4-18 |
| Noise Characteristics..... | 4-19 |
| September, 1983 | 4-1 |

INTENTIONALLY LEFT BLANK

All airspeeds quoted in this section are indicated airspeeds (IAS) and assume zero instrument error.

SPEEDS FOR SAFE OPERATION (3900 LBS)

| | |
|---|---------|
| Maximum Demonstrated Crosswind Component..... | 25 kts |
| Takeoff: | |
| Lift-off..... | 71 kts |
| 50-ft Speed..... | 80 kts |
| Two-Engine Best Angle-of-Climb (V_X)..... | 71 kts |
| Two-Engine Best Rate-of-Climb (V_Y) | 85 kts |
| Cruise Climb | 100 kts |
| Turbulent Air Penetration..... | 132 kts |
| Landing Approach: | |
| Flaps UP | 87 kts |
| Flaps DOWN (DN)..... | 76 kts |
| Balked Landing Climb..... | 71 kts |
| Intentional One-Engine-Inoperative | |
| Speed (V_{SSE})..... | 71 kts |
| Air Minimum Control Speed (V_{MCA})..... | 65 kts |

PREFLIGHT INSPECTION

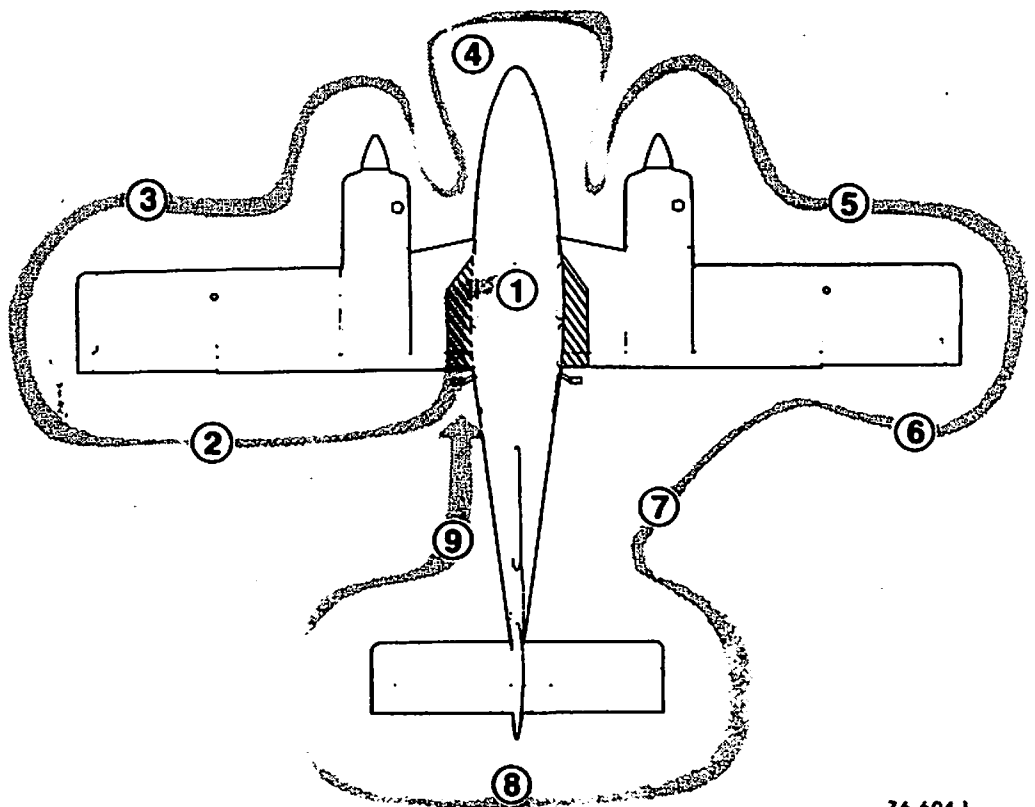

76-604.1

1. *COCKPIT*

- a. Control Lock - REMOVE AND STOW
- b. Parking Brake - SET
- c. All Switches - OFF
- d. Trim Tabs - SET TO ZERO
- e. Flush-type Fuel Drain/Emergency Gear Extension Tool - OBTAIN (refer to SYSTEMS section for information pertaining to flush-type fuel drains). This tool can also be used for opening the oil and fuel filler caps.

2. *LEFT WING TRAILING EDGE*

- a. Flap - CHECK GENERAL CONDITION
- b. Fuel Vent - CHECK, UNOBSTRUCTED
- c. Aileron - CHECK GENERAL CONDITION AND FREEDOM OF MOVEMENT
- d. Wing Tip - CHECK
- e. Position and Strobe Light - CHECK

3. *LEFT WING LEADING EDGE*

- a. Pitot - REMOVE COVER, EXAMINE FOR OBSTRUCTIONS
- b. Landing and Taxi Light - CHECK
- c. Stall Warning Vane - CHECK FREEDOM OF MOVEMENT
- d. Fuel Tank - CHECK QUANTITY; Cap - SECURE
- e. Tiedown and Chocks - REMOVE
- f. Flush-type Fuel Sump - DRAIN (use fuel-drain tool)
- g. Fuel Selector - DRAIN
- h. Engine Cowling - CHECK CONDITION AND SECURITY

- i. Air Intakes - CLEAR
- j. Propeller - EXAMINE FOR NICKS, SECURITY, AND OIL LEAKS
- k. Engine Oil - CHECK QUANTITY; Cap and Door - SECURE
- l. Cowl Flap - CHECK
- m. Wheel Well, Door, Tire, Brake Line, and Strut - CHECK
- n. Flush-type Crossfeed Fuel Drains (2) - DRAIN (use fuel-drain tool)

4. NOSE SECTION

- a. Nose Cowling and Nose Cone - CHECK CONDITION AND SECURITY
- b. Heater Air Intake - CLEAR
- c. Heater Exhaust and Vents - CLEAR
- d. Wheel Well, Doors, Tire, and Strut - CHECK

5. RIGHT WING LEADING EDGE

- a. Flush-type Crossfeed Fuel Drains (2) - DRAIN (use fuel-drain tool)
- b. Wheel Well, Door, Tire, Brake Line, and Strut - CHECK
- c. Engine Cowling - CHECK CONDITION AND SECURITY
- d. Air Intakes - CLEAR
- e. Propeller - EXAMINE FOR NICKS, SECURITY, AND OIL LEAKS
- f. Engine Oil - CHECK QUANTITY; Cap and Door - SECURE

- g. Cowl Flap - CHECK
- h. Fuel Selector - DRAIN
- i. Flush-type Fuel Sump - DRAIN
- j. Tiedown and Chocks - REMOVE
- k. Fuel Tank - CHECK QUANTITY; Cap - SECURE
- l. Stall Warning Vane - CHECK FREEDOM OF MOVEMENT
- m. Taxi Light - CHECK
- n. Wing Tip - CHECK
- o. Position and Strobe Light - CHECK

6. *RIGHT WING TRAILING EDGE*

- a. Aileron - CHECK CONDITION AND FREEDOM OF MOVEMENT
- b. Fuel Vent - CHECK, UNOBSTRUCTED
- c. Flap - CHECK GENERAL CONDITION

7. *FUSELAGE RIGHT SIDE*

- a. Battery Vents - CHECK, UNOBSTRUCTED
- b. Static Port - CLEAR OF OBSTRUCTIONS
- c. Emergency Locator Transmitter - ARMED

8. *EMPENNAGE*

- a. Control Surfaces and Trim Tabs - CHECK
- b. Tail Cone and Position Light - CHECK
- c. Tiedown - REMOVE
- d. Cabin Air Inlet - CHECK

9. FUSELAGE LEFT SIDE

- a. Static Port - CLEAR OF OBSTRUCTIONS
- b. Cabin Air Outlet - CHECK
- c. All Antennas - CHECK
- d. Load Distribution - CHECK AND SECURE
- e. Aft Utility Door - CHECK SECURE

NOTE

Check operation of lights if night flight is anticipated.

BEFORE STARTING

1. Fuel Drain/Emergency Extension Tool - STOW
2. Seats - POSITION AND LOCK; Seat Backs - UPRIGHT
3. Seat Belts and Shoulder Harnesses - FASTEN
4. Parking Brake - SET
5. All Avionics - OFF
6. Circuit Breakers - IN
7. Landing Gear Handle - DOWN
8. Carburetor Heat - OFF (up position)
9. Cowl Flap Controls - OPEN (down position)
10. Fuel Selectors - CHECK OPERATION, THEN ON
11. Light Switches - OFF
12. Battery and Alternator Switches - ON
13. Fuel Quantity Indicators - CHECK QUANTITY (See LIMITATIONS for take-off fuel)
14. Landing Gear Position Lights - CHECK

EXTERNAL POWER

The following precautions shall be observed while using external power:

CAUTION

Exercise caution when connecting the external power cable to prevent shorting the battery to the airframe or arcing the clamps of the cable together.

1. Make certain the battery switch is ON and all avionics, and electrical switches are OFF, and a battery is in the system before connecting an external power unit. This protects the voltage regulators and associated electrical equipment from voltage transients (power fluctuations).
2. The airplane has a negative ground system. Be sure to connect the positive lead of the auxiliary power unit to the positive terminal of the airplane's external power receptacle and the negative lead of the auxiliary power unit to the negative terminal of the external power receptacle.
3. To prevent arcing, make certain no power is being supplied when the connection is made.

STARTING ENGINES USING AUXILIARY POWER UNIT

1. Battery Switch - ON
2. Alternators, Electrical and Avionics Equipment - OFF
3. Auxiliary Power Unit - CONNECT
4. Auxiliary Power Unit - SET OUTPUT 13.5 to 14.25 volts (If 28-volt system - SET OUTPUT 27.0 to 28.5 volts)

5. Auxiliary Power Unit - ON
6. Left Engine - START (use normal start procedures)
7. Auxiliary Power Unit - OFF (after engine has been started)
8. Auxiliary Power Unit - DISCONNECT (before starting right engine)
9. Alternator Switches - ON

STARTING

1. Battery Switch - ON; Both ALTERNATOR-OUT UNDERVOLTAGE Lights - ILLUMINATED
2. Mixture - FULL RICH
3. Propeller - HIGH RPM (Low Pitch)
4. Throttle - FAST IDLE (1/4 Travel)
5. Aux Fuel Pump - ON
6. Magneto/Start Switch - Engage starter - PUSH TO PRIME as engine is cranking - Release to BOTH position when engine starts.

WARNING

Do not pump throttles during starting procedures.

Hot Start (Engine Hot)

- a. Mixture - FULL RICH
- b. Throttle - FAST IDLE (1/4 Travel)
- c. Fuel Boost Pump - OFF
- d. Starter - ENGAGE (Do Not Prime)

Flooded Engine:

- a. Mixture - IDLE CUT-OFF
- b. Throttle - FAST IDLE (1/4 Travel)

- c. Starter - ENGAGE (After 2 to 3 seconds prime briefly, intermittently)
- d. Mixture - ADVANCE TO FULL RICH when engine starts.

CAUTION

Maximum starter engage duty cycle is 30 seconds ON, followed by a minimum of two minutes OFF.

- 7. Engine Warm-up - 1000 to 1200 RPM
- 8. Oil Pressure - ABOVE RED RADIAL WITHIN 30 SECONDS
- 9. External Power (if used) - DISCONNECT
- 10. Alternator Switch - ON; CHECK FOR CHARGING
- 11. Starter Engaged Warning Light (if installed) - CHECK; should be illuminated during start and extinguished after start.
- 12. Using same procedure, start other engine.
- 13. Left Alternator Switch and Battery Switch - OFF. Check for Left ALTERNATOR-OUT UNDERVOLTAGE Light illuminated, and an indication of less than 75% (14-volt system) or 40% (28-volt system) on the right loadmeter.
- 14. Left Alternator Switch and Battery Switch - ON.
- 15. Right Alternator Switch and Battery Switch - OFF. Check for Right ALTERNATOR-OUT UNDERVOLTAGE Light illuminated, and an indication of less than 75% (14-volt system) or 40% (28-volt system) on the left loadmeter.
- 16. Right Alternator Switch and Battery Switch - ON.

CAUTION

If the starter engaged warning light remains illuminated after starting, or the loadmeters and/or ALTERNATOR-OUT UNDERVOLTAGE lights do not indicate/illuminate properly, an electrical malfunction is indicated. The battery switch and both alternator switches should be placed in the OFF position. Do not take off.

If the starter engaged warning light is not installed or is inoperative, and the loadmeters and/or ALTERNATOR-OUT UNDERVOLTAGE lights do not indicate/illuminate properly, an electrical malfunction is indicated. The battery switch and both alternator switches should be placed in the OFF position. Do not take off.

AFTER STARTING, AND TAXI

CAUTION

Never taxi with a flat tire or flat shock strut. During taxi operations, particular attention should be given to propeller tip clearance. Extreme caution is required when operating on unimproved or irregular surfaces or when high winds exist.

1. Avionics - ON, AS REQUIRED
2. Lights - AS REQUIRED

NOTE

Turn strobe lights off when taxiing in the vicinity of other aircraft or when flying in fog or clouds. Standard position lights are to be used for all night operations.

3. Annunciator Warning Lights - PRESS-TO-TEST
4. Aux Fuel Pumps - OFF, THEN ON (check fuel pressure indicators to verify operation of engine-driven pumps)
5. All Engine Instruments - CHECK
6. Brakes - RELEASE AND CHECK

CAUTION

Detuning the counterweight system of the engine can occur by rapid throttle operation, high rpm (low pitch) and low manifold pressure, or propeller feathering. (See latest revision of Lycoming Service Bulletin No. 245.)

BEFORE TAKEOFF

1. Seat Belts and Shoulder Harnesses - CHECK
2. Parking Brake - SET
3. Radios - CHECK
4. Flight Instruments - CHECK AND SET
5. Engine Instruments - CHECK
6. Starter Engaged Warning Light (if installed) - CHECK (should not be lit). If light is not installed or is inoperative, monitor loadmeters for proper indications.
7. Fuel Selectors - ON
8. Flight Controls - CHECK PROPER DIRECTION AND FREEDOM OF MOVEMENT

9. Wing Flaps - CHECK OPERATION
10. Electric Trim - CHECK OPERATION
11. Trim - SET TO TAKE-OFF RANGE
12. Throttles - 2200 RPM
13. Propellers - EXERCISE (100-200 rpm drop)
14. Magnetos - CHECK (175 rpm maximum drop, within 50 rpm of each other)

NOTE

Avoid operation on one magneto for more than 5 to 10 seconds. If rpm drop is excessive, lean to smooth operation and recheck.

15. Carburetor Heat - CHECK and set OFF (cold) for takeoff
16. Throttles - 1500 RPM
17. Propellers - FEATHER CHECK (Do not exceed 500 rpm drop.) Repeat 3 or 4 times in cold weather.
18. Gyro Pressure and Loadmeters - CHECK
19. Throttles - IDLE
20. Aux Fuel Pumps - CHECK ON
21. Doors and Window - SECURE
22. Parking Brake - RELEASE
23. Engine Instruments - CHECK

TAKEOFF

Take-off Power Full Throttle, 2700 rpm

1. Power - SET TAKE-OFF POWER (before brake release)
2. Mixtures - FULL RICH or lean to smooth operation as required by field elevation
3. Airspeed - ACCELERATE TO AND MAINTAIN TAKE-OFF SPEED

**Section IV
Normal Procedures**

**BEECHCRAFT
Duchess 76**

4. Landing Gear - RETRACT when airplane is positively airborne

NOTE

If red in-transit light remains illuminated after 30 seconds, place landing gear switch handle in the down position, make a normal landing and have the landing gear system checked.

5. Airspeed - ESTABLISH DESIRED CLIMB SPEED when clear of obstacles

CLIMB

Maximum Climb..... Full Throttle, 2700 RPM
Cruise Climb..... Full Throttle, 2600 RPM

1. Engine Temperatures - MONITOR
2. Power - SET
3. Mixtures - LEAN AS REQUIRED
4. Cowl Flaps - AS REQUIRED
5. Aux Fuel Pumps - OFF

CRUISE

Maximum Cruise Power 24.0 in. Hg or
full throttle, at 2700 rpm
Recommended Cruise Power 24.0 in. Hg or
full throttle, at 2500 rpm
Recommended Cruise Power 24.0 in. Hg or
full throttle, at 2300 rpm
Economy Cruise Power 20.0 in. Hg or
full throttle, at 2300 rpm

1. Power - SET AS DESIRED (Use Tables in PERFORMANCE section)
2. Mixtures - LEAN AS REQUIRED
3. Cowl Flaps - AS REQUIRED

**LEANING MIXTURE USING THE EXHAUST GAS
TEMPERATURE INDICATOR (EGT)**

For level flight at 75% power or less, the EGT unit should be used in the following manner:

1. Lean the mixture and note the point on the indicator at which the temperature peaks and starts to fall.
 - a. **CRUISE (LEAN) MIXTURE** - Enrich mixture (push mixture control forward) until EGT indicator shows a drop of 25°F to 50°F on rich side of peak.
 - b. **BEST POWER MIXTURE** - Enrich mixture (push mixture control forward) until EGT indicator shows a drop of 75°F to 100°F on rich side of peak.

CAUTION

Do not continue to lean mixture beyond the point necessary to establish peak temperature. Continuous operation is recommended at 25°F or below peak EGT only on rich side of peak.

2. Changes in altitude and power setting require EGT to be rechecked and mixture reset.
3. A mixture resulting in an EGT 25°F on the rich side of peak should also result in fuel flow and TAS values approximately equal to those presented in the Cruise Power Settings tables in the PERFORMANCE Section. If not, the values derived from the Range, Endurance, and Cruise Speeds charts must be revised accordingly. In very cold weather, EGT's 25°F rich of peak may not be obtainable.

DESCENT

1. Altimeter - SET
2. Cowl Flaps - CLOSE
3. Windshield Defroster - AS REQUIRED
4. Carburetor Heat - FULL ON or FULL OFF, AS REQUIRED
5. Power - AS REQUIRED (avoid prolonged idle settings and low cylinder head temperatures)
6. Mixtures - ENRICH AS REQUIRED

BEFORE LANDING

1. Seat Belts and Shoulder Harnesses - FASTENED, SEAT BACKS UPRIGHT
2. Fuel Selectors - CHECK ON
3. Aux Fuel Pumps - ON
4. Mixture Controls - FULL RICH (or as required by field elevation)
5. Carburetor Heat - FULL ON or FULL OFF AS REQUIRED

NOTE

In the event of a go-around, Carburetor Heat shall be in the full OFF (cold) position after full throttle application.

6. Cowl Flaps - AS REQUIRED
7. Landing Gear - DOWN (140 KTS Maximum)
8. Landing and Taxi Lights - AS REQUIRED
9. Wing Flaps - FULL DOWN (DN) (110 KTS Maximum)
10. Airspeed - ESTABLISH LANDING APPROACH SPEED
11. Propellers - HIGH RPM

BALKED LANDING

1. Propellers - HIGH RPM
2. Throttles - FULL FORWARD
3. Airspeed - 71 KTS
4. Wing Flaps - UP
5. Landing Gear - UP
6. Cowl Flaps - AS REQUIRED

AFTER LANDING

1. Landing and Taxi Lights - AS REQUIRED
2. Wing Flaps - UP
3. Trim Tabs - SET TO TAKE-OFF RANGE
4. Cowl Flaps - OPEN

SHUTDOWN

1. Parking Brake - SET
2. Aux Fuel Pumps - OFF
3. Electrical and Avionics Equipment - OFF
4. Propellers - HIGH RPM
5. Throttles - 1000 RPM
6. Mixtures - IDLE CUT-OFF
7. Magneto/Start Switches - OFF, after engines stop
8. Battery and Alternator Switches - OFF
9. Controls - LOCKED
10. Install wheel chocks and release brakes if the airplane is to be left unattended.

INTENTIONALLY LEFT BLANK

ENVIRONMENTAL SYSTEMS

HEATING AND VENTILATION

Refer to the SYSTEMS DESCRIPTION section for operation of heating and ventilation controls.

ELECTRIC ELEVATOR TRIM

1. On/Off Switch - ON
2. Control Wheel Trim Switch - Depress and move forward for nose down, aft for nose up, and when released, the switch returns to the center (OFF) position.

Procedure for UNSCHEDULED ELECTRIC ELEVATOR TRIM is given in EMERGENCY PROCEDURES Section. █

COLD WEATHER OPERATION

PREFLIGHT INSPECTION

All accumulations of ice, snow and frost must be removed from the wings, tail, control surfaces and hinges, propellers, windshield, fuel cell filler caps, crankcase vents, and fuel vents. If such accumulations are not removed completely, the airplane shall not be flown. The deposits will not blow off in flight. While an adverse weight factor is clearly involved in the case of heavy deposits, it is less obvious that even slight accumulations will disturb or completely destroy the designed aerodynamic properties of the airfoils.

The normal preflight procedures should then be completed, with particular attention given to check of flight controls for complete freedom of movement.

ENGINES

Use engine oil in accordance with Consumable Materials in the HANDLING, SERVICING AND MAINTENANCE section.

WARNING

■ Ascertain that magneto/start switches and battery master switch are OFF before moving propeller by hand.

Always pull the propeller through by hand, opposite the direction of rotation, several times to clear the engine and "limber up" the cold, heavy oil before using the starter. This will also lessen the load on the battery if external power is not used.

Under very cold conditions, it may be necessary to preheat the engines prior to a start. Particular attention should be given to the oil cooler, engine sump and propeller hub to

ensure proper preheat. A start with congealed oil in the system may produce an indication of normal pressure immediately after the start, but then the oil pressure may decrease when residual oil in the engine is pumped back with the congealed oil in the sump. If an engine heater capable of heating both the engine sump and cooler is not available, the oil should be drained while the engine is hot and stored in a warm area until the next flight.

If there is no oil pressure within the first 30 seconds of running, or if oil pressure drops after a few minutes of ground operation, shut down and check for broken oil lines, oil cooler leaks or the possibility of congealed oil.

NOTE

It is advisable to use external power for starting in cold weather.

During warm-up, monitor engine temperatures closely, since it is quite possible to exceed the cylinder head temperature limit in trying to bring up the oil temperature. Exercise the propellers several times to remove cold oil from the pitch change mechanism. The propellers should also be cycled occasionally in flight.

During letdown and landing, give special attention to engine temperatures, since the engines will have a tendency toward overcooling.

TAXIING

Avoid taxiing through water, slush, or muddy surfaces if possible. In cold weather, water, slush, or mud, when splashed onto landing gear mechanisms or control surface hinges may freeze, preventing free movement and resulting in structural damage.

PRACTICE DEMONSTRATION OF VMCA

VMCA demonstration may be required for multi-engine pilot certification. The following procedure shall be used at a safe altitude of at least 5000 feet above the ground in clear air only.

WARNING

**INFLIGHT ENGINE CUTS BELOW VSSE
SPEED OF 71 KTS ARE PROHIBITED.**

1. Landing Gear - UP
2. Wing Flaps - UP
3. Airspeed - ABOVE 71 KTS (VSSE)
4. Propeller Levers - HIGH RPM
5. Throttle (simulated inoperative engine) - IDLE
6. Throttle (other engine) - FULL FORWARD
7. Airspeed - REDUCE approximately 1 knot per second until either VMCA or stall warning is obtained.

CAUTION

Use rudder to maintain directional control (heading) and ailerons to maintain 5° bank towards the operative engine (lateral attitude). At the first sign of either VMCA or stall warning (which may be evidenced by: inability to maintain heading or lateral attitude, aerodynamic stall buffet, or stall warning horn sound) immediately initiate recovery: reduce power to idle on the operative engine and immediately lower the nose to regain VSSE.

NOISE CHARACTERISTICS

Approach to and departure from an airport should be made so as to avoid prolonged flight at low altitude near noise-sensitive areas. Avoidance of noise-sensitive areas, if practical, is preferable to overflight at relatively low altitudes.

For VFR operations over outdoor assemblies of persons, recreational and park areas, and other noise-sensitive areas, pilots should make every effort to fly not less than 2000 feet above the surface, weather permitting, even though flight at a lower level may be consistent with the provisions of government regulations.

NOTE

The preceding recommended procedures do not apply where they would conflict with Air Traffic Control clearances or instructions, or where, in the pilot's judgement, an altitude of less than 2000 feet is necessary to adequately exercise his duty to see and avoid other airplanes.

Flyover noise level established in compliance with FAR 36 is:

78.7 dB(A)

No determination has been made by the Federal Aviation Administration that the noise level of this airplane is or should be acceptable or unacceptable for operation at, into, or out of any airport.

PERFORMANCE

1

1

SECTION V PERFORMANCE

TABLE OF CONTENTS

| <i>SUBJECT</i> | <i>PAGE</i> |
|---|-------------|
| Introduction to Performance and Flight Planning | 5-3 |
| Conditions | 5-3 – 5-13 |
| Comments Pertinent to the Use of Performance Graphs..... | 5-14 |
| Airspeed Calibration – Normal System..... | 5-16 |
| Altimeter Correction – Normal System | 5-17 |
| Airspeed Calibration – Alternate System..... | 5-18 |
| Altimeter Correction – Alternate System..... | 5-19 |
| Fahrenheit to Celsius Temperature Conversion..... | 5-20 |
| ISA Conversion..... | 5-21 |
| Manifold Pressure vs RPM..... | 5-22 |
| Take-Off Weight..... | 5-23 |
| Stall Speeds – Power Idle..... | 5-24 |
| Wind Components | 5-25 |
| Take-Off Distance..... | 5-26 |
| Take-Off Distance – Grass Surface..... | 5-27 |
| Accelerate-Stop Distance | 5-28 |
| Accelerate-Go Distance..... | 5-29 |
| Climb – Two Engine | 5-30 |
| Take-Off Climb Gradient, One Engine Inoperative | 5-31 |
| Time, Fuel, and Distance to Climb | 5-32 |
| Climb – One Engine Inoperative..... | 5-33 |
| Service Ceiling – One Engine Inoperative | 5-34 |

TABLE OF CONTENTS (Continued)

| <i>SUBJECT</i> | <i>PAGE</i> |
|--|-------------|
| Cruise Speeds | 5-35 |
| Cruise Power Settings | 5-36 - 5-40 |
| Maximum Cruise Power | 5-36 |
| Recommended Cruise Power | 5-37 |
| Recommended Cruise Power | 5-38 |
| Recommended Cruise Power | 5-39 |
| Economy Cruise Power | 5-40 |
| Range Profile – 100 Gallons..... | 5-40B |
| Endurance Profile – 100 Gallons..... | 5-41 |
| Holding Time..... | 5-42 |
| Time, Fuel, and Distance to Descend | 5-43 |
| Climb – Balked Landing..... | 5-44 |
| Landing Distance – Flaps Down (DN)..... | 5-45 |
| Landing Distance – Flaps Up..... | 5-46 |
| Landing Distance – Grass Surface – Flaps Down (DN)..... | 5-47 |

**INTRODUCTION TO PERFORMANCE
AND FLIGHT PLANNING**

All airspeeds quoted in this section are indicated airspeeds (IAS) except as noted and assume zero instrument error.

The graphs and tables in this section present performance information for takeoff, climb, landing and flight planning at various parameters of weight, power, altitude, and temperature. FAA approved performance information is included in this section. Examples are presented on all performance graphs. In addition, the calculations for flight time, block speed, and fuel required are presented using the conditions listed.

CONDITIONS

At Denver:

Outside Air Temperature 15°C (59°F)
Field Elevation 5330 ft
Altimeter Setting 29.60 in. Hg
Wind 270° at 10 kts
Runway 26L length 10,010 ft

**Route of Trip
DEN-V81-AMA**

For VFR Cruise at 11,500 feet

**Section V
Performance**

**BEECHCRAFT
Duchess 76**

| ROUTE SEGMENT | MAGNETIC COURSE | DIST NM | WIND 11,500 FEET DIR/KTS | OAT 11,500 FEET °C | ALT SETTING IN. HG |
|--------------------------|----------------------------|--------------------|---|---------------------------------------|-----------------------------------|
| DEN-COS | 161° | 55 | 010/30 | -5 | 29.60 |
| COS-PUB | 153° | 40 | 010/30 | -5 | 29.60 |
| PUB-TBE | 134° | 74 | 100/20 | 0 | 29.56 |
| TBE-DHT | 132° | 87 | 200/20 | 9 | 29.56 |
| DHT-AMA | 125° | 65 | 200/20 | 10 | 29.56 |

REFERENCE: Enroute Low Altitude Chart L-6

At Amarillo:

Outside Air Temperature 25°C (77°F)
 Field Elevation 3605 ft
 Altimeter Setting 29.56 in. Hg
 Wind 180° at 10 kts
 Runway 21 Length 10,000 ft

To determine pressure altitude at origin and destination airports, add 100 feet to field elevation for each .1 in. Hg below 29.92, and subtract 100 feet from field elevation for each .1 in. Hg above 29.92.

Pressure Altitude at DEN:

$$29.92 - 29.60 = .32 \text{ in. Hg}$$

The pressure altitude at DEN is 320 feet above the field elevation.

$$5330 + 320 = 5650 \text{ ft}$$

**BEECHCRAFT
Duchess 76**

**Section V
Performance**

Pressure Altitude at AMA:

$$29.92 - 29.56 = .36 \text{ in. Hg}$$

The pressure altitude at AMA is 360 feet above the field elevation.

$$3605 + 360 = 3965 \text{ ft}$$

NOTE

For flight planning, the difference between cruise altitude and cruise pressure altitude has been ignored.

Maximum Allowable Take-off Weight = 3900 lbs

Ramp Weight = 3900 + 16 = 3916 lbs

NOTE

Fuel for start, taxi, and takeoff is normally 16 pounds.

Enter the Take-Off Weight graph at 5650 feet pressure altitude and 15°C.

The take-off weight to achieve a positive rate-of-climb at lift-off for one engine inoperative is:

Take-off Weight = 2925 pounds

**Section V
Performance**

**BEEHCRAFT
Duchess 76**

Enter the Take-Off Distance graph at 15°C, 5650 feet pressure altitude, 3900 pounds, and 9.5 knots headwind component.

Ground Roll.....1680 ft
Total Distance over 50-ft Obstacle3670 ft

Enter the Accelerate-Stop graph at 15°C, 5650 feet pressure altitude, 3900 pounds, and 9.5 knots headwind component:

Accelerate-Stop Distance3250 ft

NOTE

Since 3250 feet is less than the available field length (10,010 ft), the accelerate-stop procedure can be performed at any weight.

Takeoff at 3900 lbs can be accomplished. However, if an engine failure occurs prior to retraction of landing gear, the accelerate-stop procedure must be performed (even if airborne, unless sufficient altitude is available for retraction of landing gear while descending).

The following example assumes 15°C, SL pressure altitude, and a take-off weight of 3350 pounds.

Although not required by regulations, information has been presented to determine the take-off weight, field requirements and take-off flight path assuming an engine failure occurs during the take-off procedure. The following illustrates the use of these charts.

Enter the Accelerate-Go graph at 15°C, SL pressure altitude, 3350 pounds, and 10 knots headwind component:

Total Distance Over 50-ft Obstacle4700 ft
Ground Roll.....940 ft

Enter the graph for Take-off Climb Gradient – One Engine Inoperative at 15°C, SL pressure altitude, and 3350 pounds:

Climb Gradient..... 4.6%

A 4.6% climb gradient is 46 feet of vertical height per 1000 feet of horizontal distance.

NOTE

The Take-off Climb Gradient – One Engine Inoperative graph assumes zero wind conditions. Climbing into a headwind will result in higher angles of climb, and hence, better obstacle clearance capabilities.

**Section V
Performance**

**BEECHCRAFT
Duchess 76**

Calculation of horizontal distance to clear an obstacle 90 feet above the runway surface:

Horizontal distance used to climb from 50 feet to 90 feet
 $= (90 - 50) (1000 \div 46) = 870$ feet

Total Distance = 4700 + 870 = 5570 feet

The above results are illustrated below:

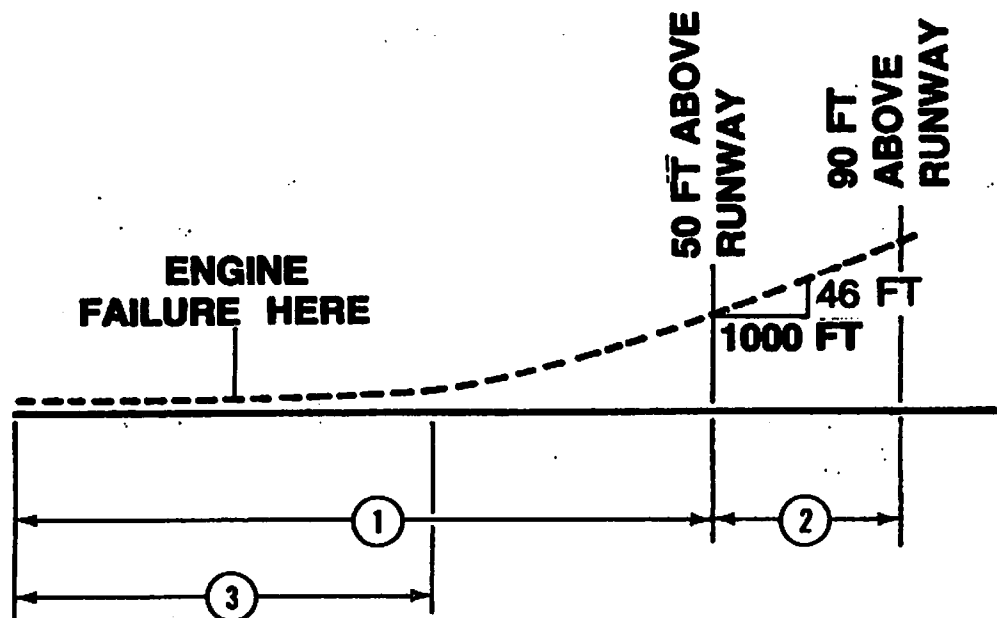

① Accelerate-go take-off distance = 4700 feet

② Distance to climb from 50 ft. to 90 ft. above runway = 870 feet

The following calculations provide information for the flight planning procedure. All examples are presented on the performance graphs. A take-off weight of 3900 pounds has been assumed.

Enter the Time, Fuel, and Distance to Climb graph at 15°C to 5650 feet and to 3900 pounds. Also enter at -5°C to 11,500 feet and to 3900 pounds. Read:

$$\begin{aligned}\text{Time to Climb} &= 14 - 6 = 8 \text{ min} \\ \text{Fuel Used to Climb} &= 6.1 - 2.8 = 3.3 \text{ gal} \\ \text{Distance Traveled} &= 24 - 10 = 14 \text{ NM}\end{aligned}$$

The temperatures for cruise are presented for a standard day (ISA); 20°C (36°F) above a standard day (ISA + 20°C); and 20°C (36°F) below a standard day (ISA - 20°C). These should be used for flight planning. The IOAT values are true temperature values which have been adjusted for the compressibility effects. IOAT should be used for setting cruise power while enroute.

Enter the graph for ISA conversion at 11,500 feet and the temperature for the route segment:

| | | | |
|---------|---------------|---|------------|
| DEN-PUB | OAT | = | -5°C |
| | ISA Condition | = | ISA + 3°C |
| PUB-TBE | OAT | = | 0°C |
| | ISA Condition | = | ISA + 8°C |
| TBE-DHT | OAT | = | 9°C |
| | ISA Condition | = | ISA + 17°C |
| DHT-AMA | OAT | = | 10°C |
| | ISA Condition | = | ISA + 18°C |

Enter the table for Recommended Cruise Power - 24 in. Hg, 2500 RPM at 11,000 ft, 12,000 ft, ISA and ISA + 20°C.

**Section V
Performance**

**BEECHCRAFT
Duchess 76**

| ALTI- TUDE FEET | TEMPERATURE | | | | | |
|-----------------------|--------------------------|-----------------------------|--------------|--------------------------|-----------------------------|--------------|
| | ISA | | | ISA + 20°C | | |
| | MAN. PRESS. IN. HG | FUEL FLOW GPH/ ENG | TAS KNOTS | MAN. PRESS. IN. HG | FUEL FLOW GPH/ ENG | TAS KNOTS |
| 11,000 | 19.4 | 8.8 | 157 | 19.4 | 8.5 | 158 |
| 12,000 | 18.7 | 8.5 | 156 | 18.7 | 8.2 | 156 |

Interpolate for 11,500 feet and the temperature for the appropriate route segment. Results of the interpolations are:

| ROUTE SEGMENT | MAN. PRESS. IN. HG | FUEL FLOW GPH/ENG | TAS KNOTS |
|------------------|--------------------------|-------------------------|--------------|
| DEN-PUB | 19.1 | 8.7 | 157 |
| PUB-TBE | 19.1 | 8.6 | 157 |
| TBE-DHT | 19.1 | 8.5 | 157 |
| DHT-AMA | 19.1 | 8.4 | 157 |

NOTE

The above are exact values for the assumed conditions.

**BEECHCRAFT
Duchess 76**

**Section V
Performance**

Enter the graph for Descent at 11,500 feet to the descent line, and enter again at 3965 feet to the descent line, and read:

$$\begin{aligned} \text{Time to Descend} &= 10 - 4 = 6 \text{ min} \\ \text{Fuel Used to Descend} &= 3.35 - 1.28 = 2.07 \text{ gal} \\ \text{Distance to Descend} &= 32 - 11 = 21 \text{ NM} \end{aligned}$$

Time and fuel used were calculated at Recommended Cruise Power – 24 in. Hg 2500 RPM as follows:

$$\text{Time} = \frac{\text{Distance}}{\text{Ground Speed}}$$

$$\text{Fuel Used} = (\text{Time}) (\text{Total Fuel Flow})$$

Results are:

| ROUTE SEGMENT | DISTANCE | EST GROUND SPEED | TIME AT CRUISE ALTITUDE | FUEL USED FOR CRUISE |
|------------------|----------|------------------------|-------------------------------|-------------------------------|
| | NM | KNOTS | HRS: MIN | GAL |
| DEN-COS | *41 | 184 | : 13 | 3.8 |
| COS-PUB | 40 | 183 | : 13 | 3.7 |
| PUB-TBE | 74 | 143 | : 31 | 8.9 |
| TBE-DHT | 87 | 146 | : 36 | 10.2 |
| DHT-AMA | *44 | 148 | : 18 | 5.1 |

*Distance required to climb or descend has been subtracted from segment distance.

TIME – FUEL – DISTANCE

| ITEM | TIME HRS: MINS | FUEL GAL | DISTANCE NM |
|---|---------------------------|---------------------|------------------------|
| Start, Runup, Taxi, and Take- off | 0:00 | 2.7 | 0 |
| Climb | :08 | 3.3 | 14 |
| Cruise | 1:51 | 31.7 | 260 |
| Descent | :06 | 2.1 | 21 |
| Total | 2:05 | 39.8 | 321 |

Total Flight Time: 2 hours, 5 minutes

Block Speed: 321 NM ÷ 2 hours, 5 minutes = 154 knots

Reserve Fuel: (45 minutes at Economy Cruise Power):

Enter the cruise power settings table for Economy Cruise Power at 11,500 feet for ISA (assume ISA Fuel Flow Rate).

Fuel Flow Per Engine = 8.0 gal/hr

Total Fuel Flow = 16.0 gal/hr (96 lbs/hr)

Reserve Fuel = (45 min) (96 lbs/hr) = 72 lbs (12 gal)

Total Fuel = 39.8 + 12.0 = 51.8 gallons

**BEECHCRAFT
Duchess 76**

**Section V
Performance**

The estimated landing weight is determined by subtracting the fuel required for the flight from the ramp weight:

Assumed ramp weight = 3916 lbs

Estimated fuel from DEN to AMA = 39.8 gal (239 lbs)

Estimated landing weight = 3916 - 239 = 3677 lbs

Examples have been provided on the performance graphs. The above conditions have been used throughout. Rate of climb was determined for the initial cruise altitude conditions.

Enter the graph for Landing Distance – Flaps Down (DN) at 25°C, 3965 feet pressure altitude, 3677 pounds and 9.5 kts headwind component:

Ground Roll 1050 ft
Total Distance over 50-ft Obstacle..... 1970 ft
Approach Speed..... 76 kts

Enter the graph for Climb – Balked Landing at 25°C, 3965 feet pressure altitude and 3677 pounds:

Rate-of-Climb 610 ft/min
Climb Gradient..... 8.0%

**COMMENTS PERTINENT TO THE USE OF
PERFORMANCE GRAPHS**

1. The example, in addition to presenting an answer for a particular set of conditions, also presents the order in which the graphs should normally be used, i.e., if the first item in the example is OAT, then enter the graph at the known OAT.
2. The reference lines indicate where to begin following guide lines, always project to the reference line first, then follow the guide lines to the next known item.
3. Indicated airspeeds (IAS) were obtained by using the Airspeed Calibration – Normal System.
4. The associated conditions define the specific conditions from which performance parameters have been determined. They are not intended to be used as instructions; however, performance values determined from charts can only be achieved if specified conditions exist.
5. The full amount of usable fuel is available for all approved flight conditions.

INTENTIONALLY LEFT BLANK

AIRSPEED CALIBRATION - NORMAL SYSTEM

NOTE: INDICATED AIRSPEED ASSUMES ZERO INSTRUMENT ERROR

EXAMPLE:

| | |
|------------|-----------|
| IAS..... | 75 KTS |
| FLAPS..... | DOWN (DN) |
| <hr/> | |
| CAS..... | 75 KTS |

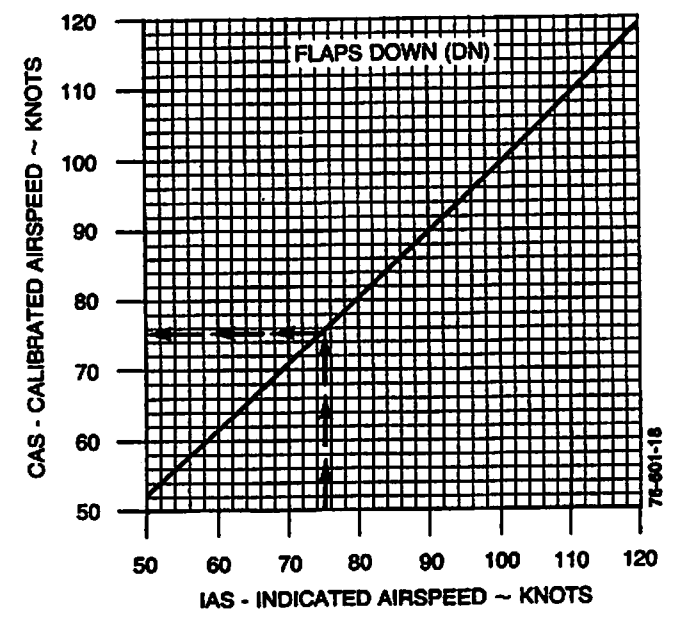
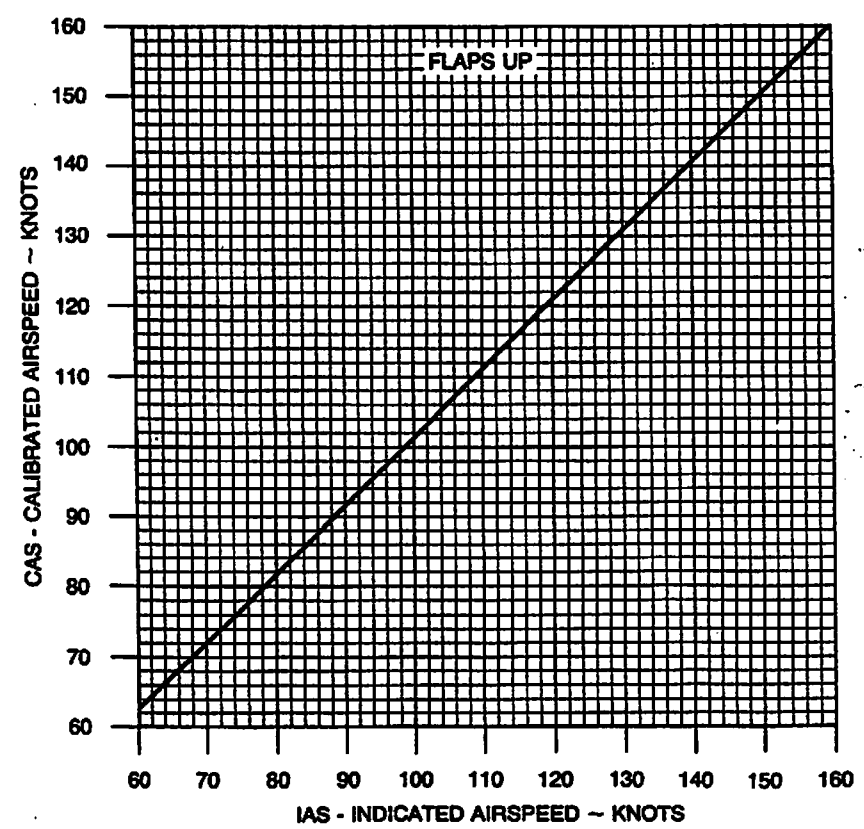

91-109-92

ALTIMETER CORRECTION - NORMAL SYSTEM

EXAMPLE:

| | |
|-----------------------------------|-----------|
| IAS | 75 KTS |
| FLAPS | DOWN (DN) |
| INDICATED PRESSURE ALTITUDE | 4000 FT |
| <hr/> | |
| ALTIMETER CORRECTION | +2 FT |
| ACTUAL PRESSURE ALTITUDE | 4002 FT |

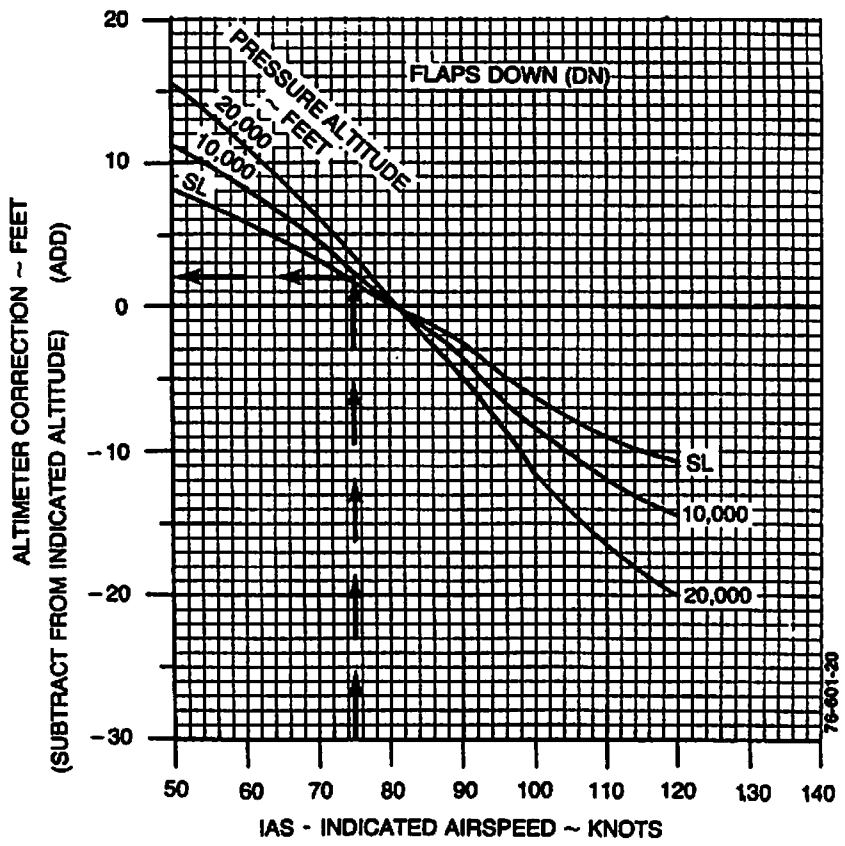
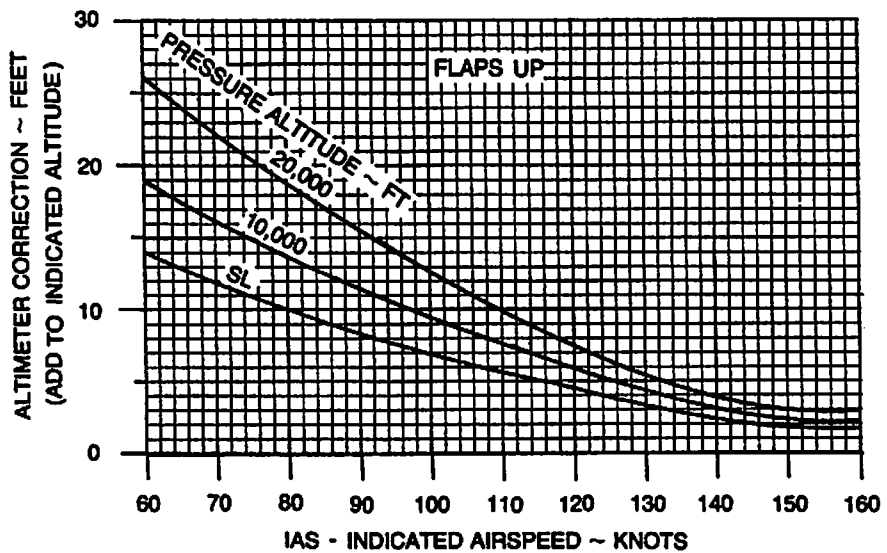

AIRSPEED CALIBRATION - ALTERNATE SYSTEM

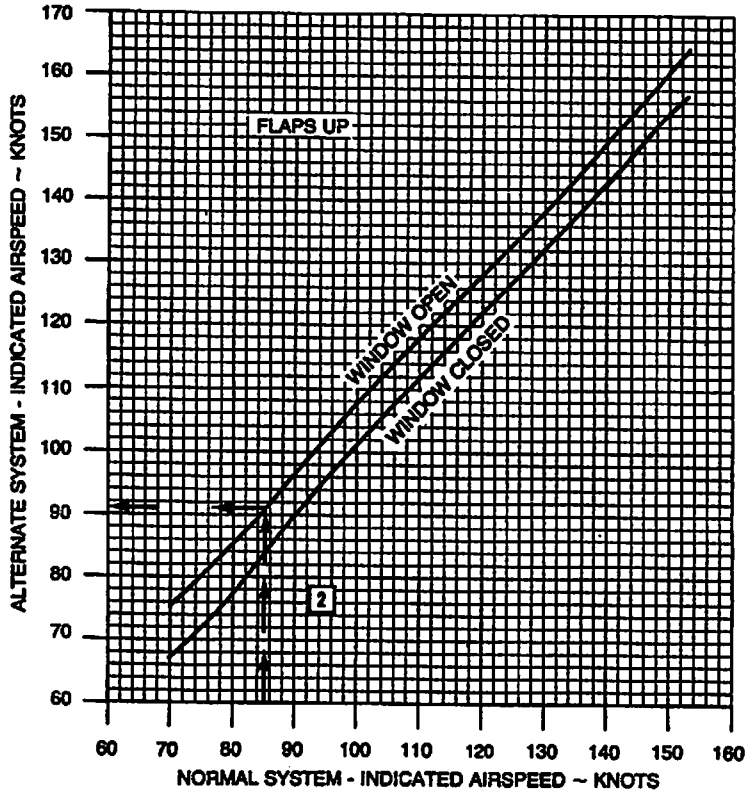

EXAMPLE:

1 FLAPSDOWN (DN)
 STORM WINDOWCLOSED
 IAS - ALTERNATE SYSTEM69 KTS

IAS - NORMAL SYSTEM75 KTS
 CAS - (SEE AIRSPEED CALIBRATION75 KTS
 NORMAL SYSTEM)

2 FLAPSUP
 STORM WINDOWOPEN
 IAS - NORMAL SYSTEM85 KTS

IAS - ALTERNATE SYSTEM91 KTS

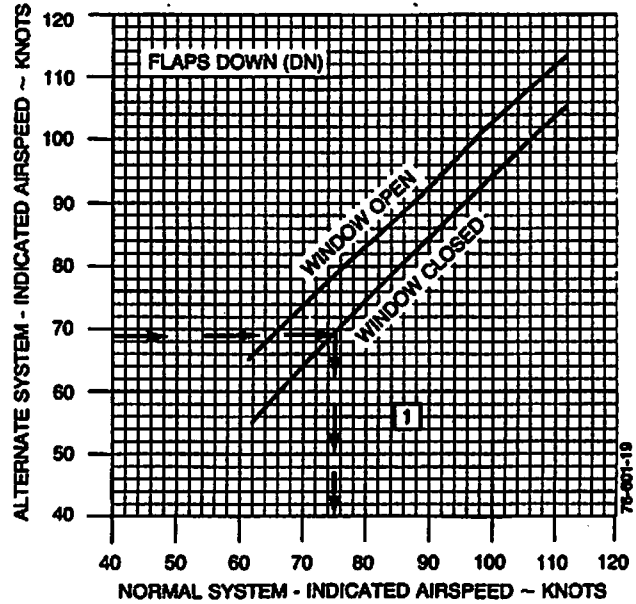

ALTIMETER CORRECTION - ALTERNATE SYSTEM

EXAMPLE:

| | |
|----------------------------------|-----------|
| IAS..... | 75 KTS |
| FLAPS..... | DOWN (DN) |
| INDICATED PRESSURE ALTITUDE..... | 4000 FT |
| STORM WINDOW..... | OPEN |
| <hr/> | |
| ALTIMETER CORRECTION..... | - 25 FT |
| ACTUAL PRESSURE ALTITUDE..... | 3975 FT |

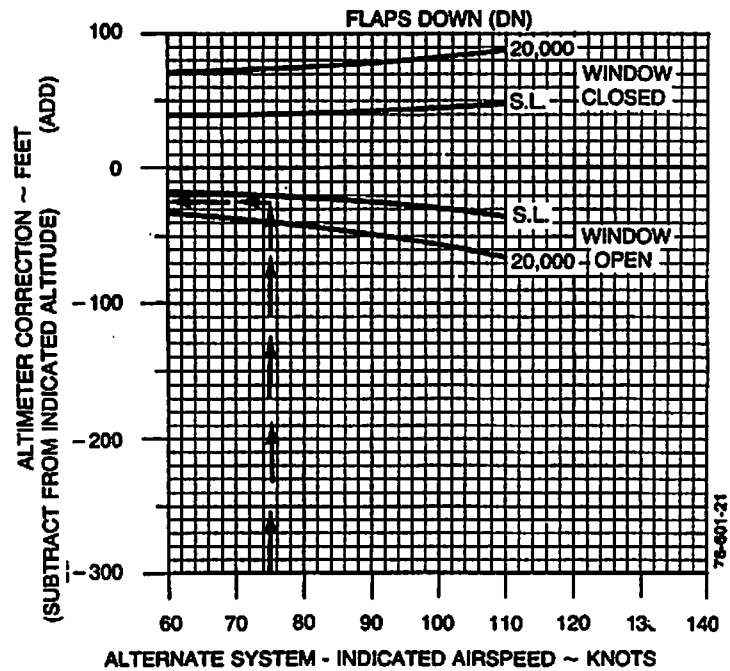
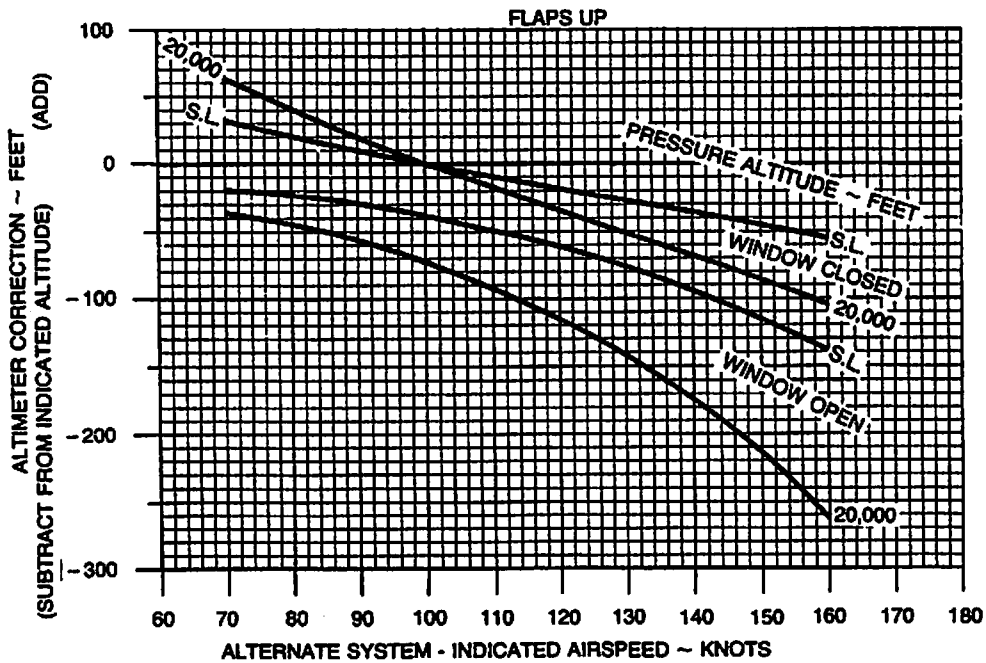

11-601-21

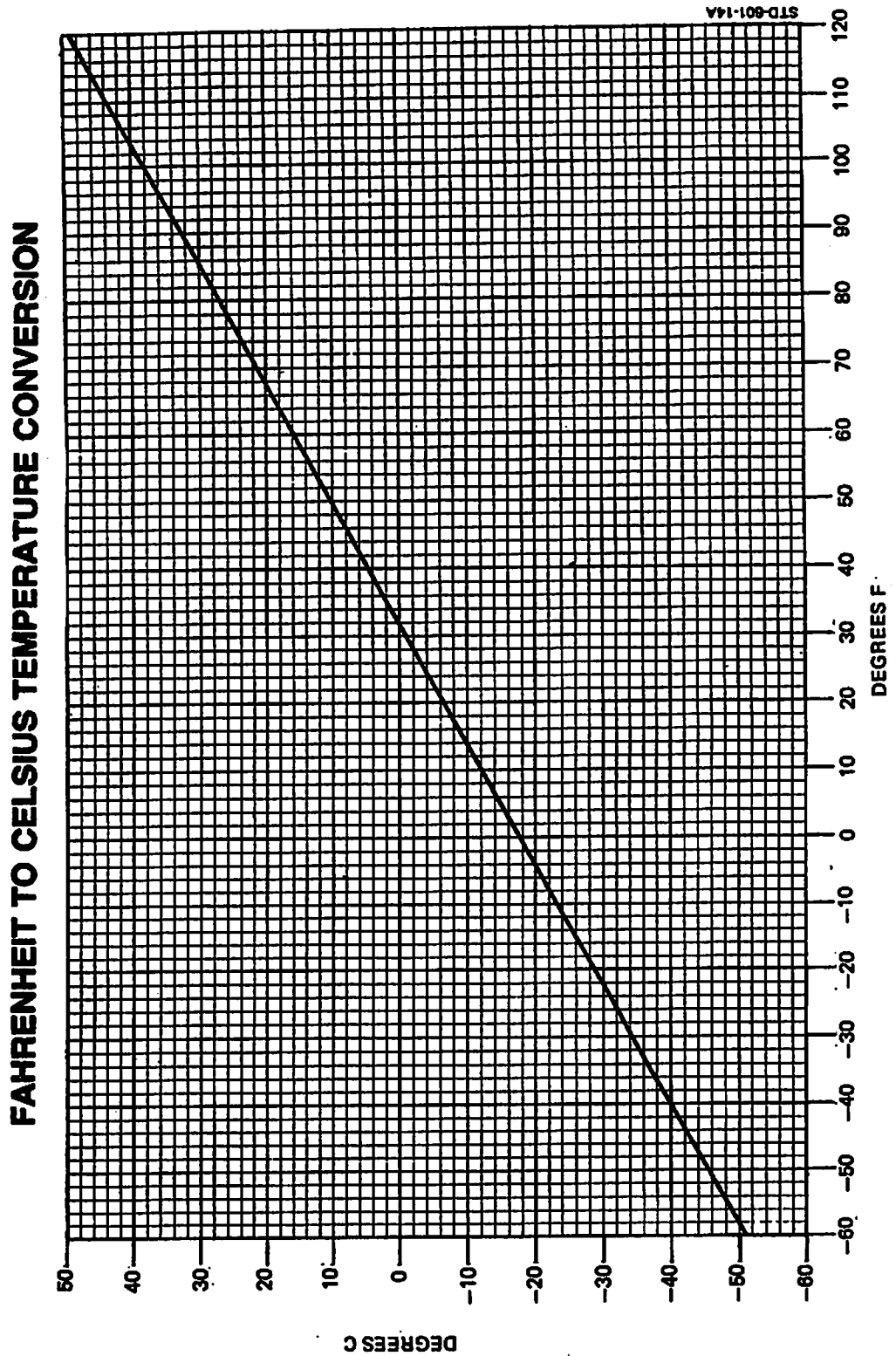

ISA CONVERSION
PRESSURE ALTITUDE vs OUTSIDE AIR TEMPERATURE

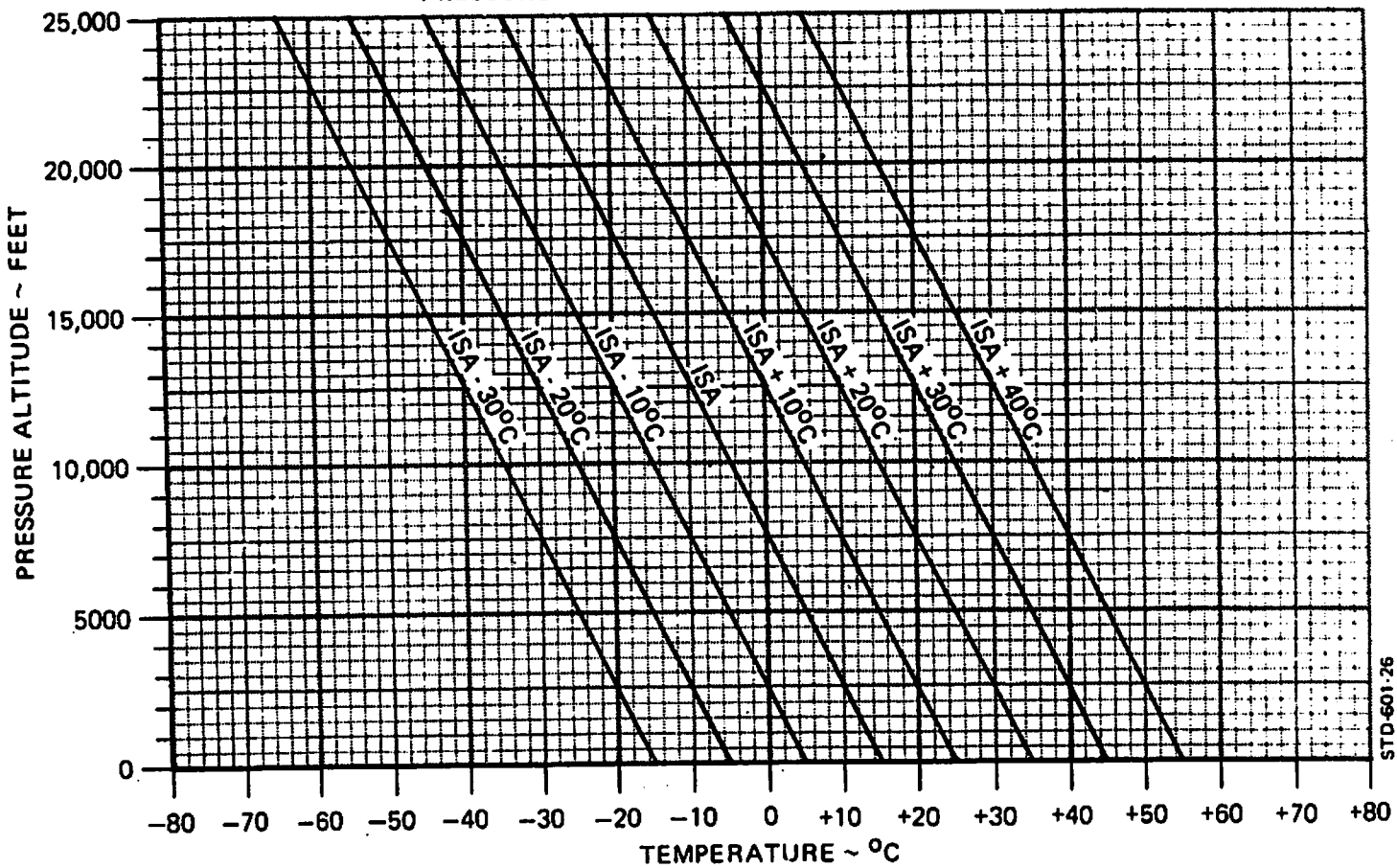

STD 601.26

MANIFOLD PRESSURE vs RPM

EXAMPLE:

ENGINE SPEED 2500 RPM
MANIFOLD PRESSURE . . . 19.1 IN. HG

WITHIN RECOMMENDED LIMITS

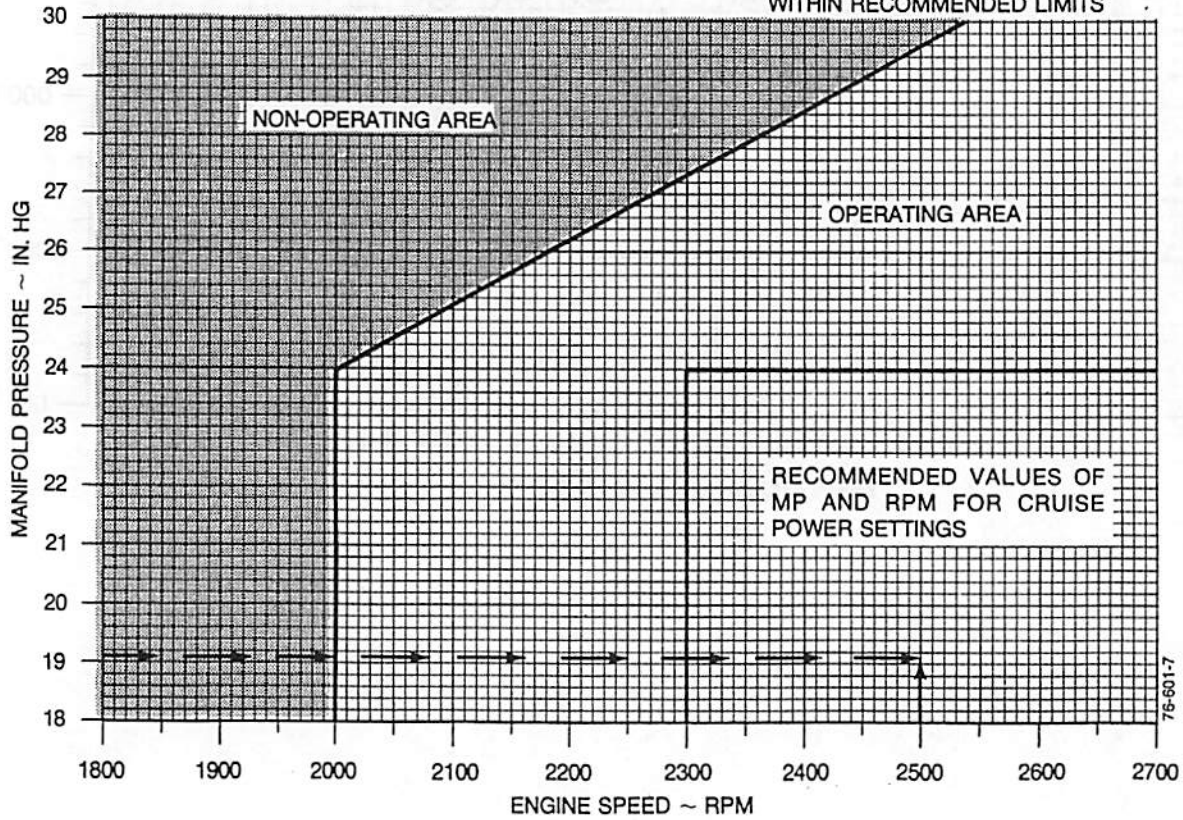

76-601-7

**TAKE-OFF WEIGHT
TO ACHIEVE POSITIVE SINGLE ENGINE
RATE OF CLIMB AT LIFT-OFF**

ASSOCIATED CONDITIONS:

AIRPLANE.....AIRBORNE
 POWER.....TAKE-OFF AT
 2700 RPM
 FLAPS.....UP
 LANDING GEAR.....DOWN
 INOPERATIVE PROPELLER...FEATHERED

EXAMPLE:

PRESSURE ALTITUDE.....5650 FT
 OAT.....15°C
 TAKE-OFF WEIGHT.....2925 LBS

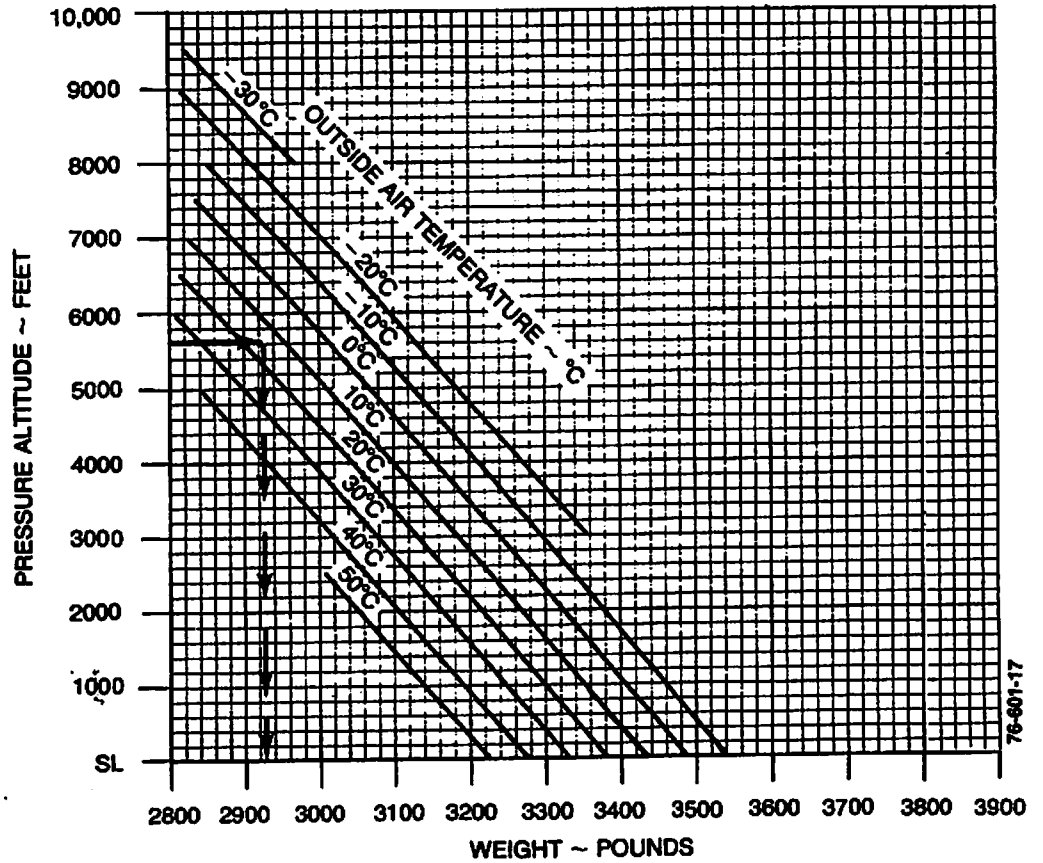

STALL SPEEDS - POWER IDLE

- NOTES:
1. THE MAXIMUM ALTITUDE LOSS EXPERIENCED WHILE CONDUCTING STALLS IN ACCORDANCE WITH FAR 23.201 WAS 400 FEET.
 2. MAXIMUM NOSE DOWN, PITCH ATTITUDE AND ALTITUDE LOSS DURING RECOVERY FROM ONE ENGINE INOPERATIVE STALLS PER FAR 23.205 ARE 5° AND 100 FEET RESPECTIVELY.
 3. A NORMAL STALL RECOVERY TECHNIQUE MAY BE USED.

EXAMPLE:

WEIGHT3877 LBS
 FLAPSDOWN (DN)
 ANGLE OF BANK30°

STALL SPEED64 KTS IAS
 62 KTS CAS

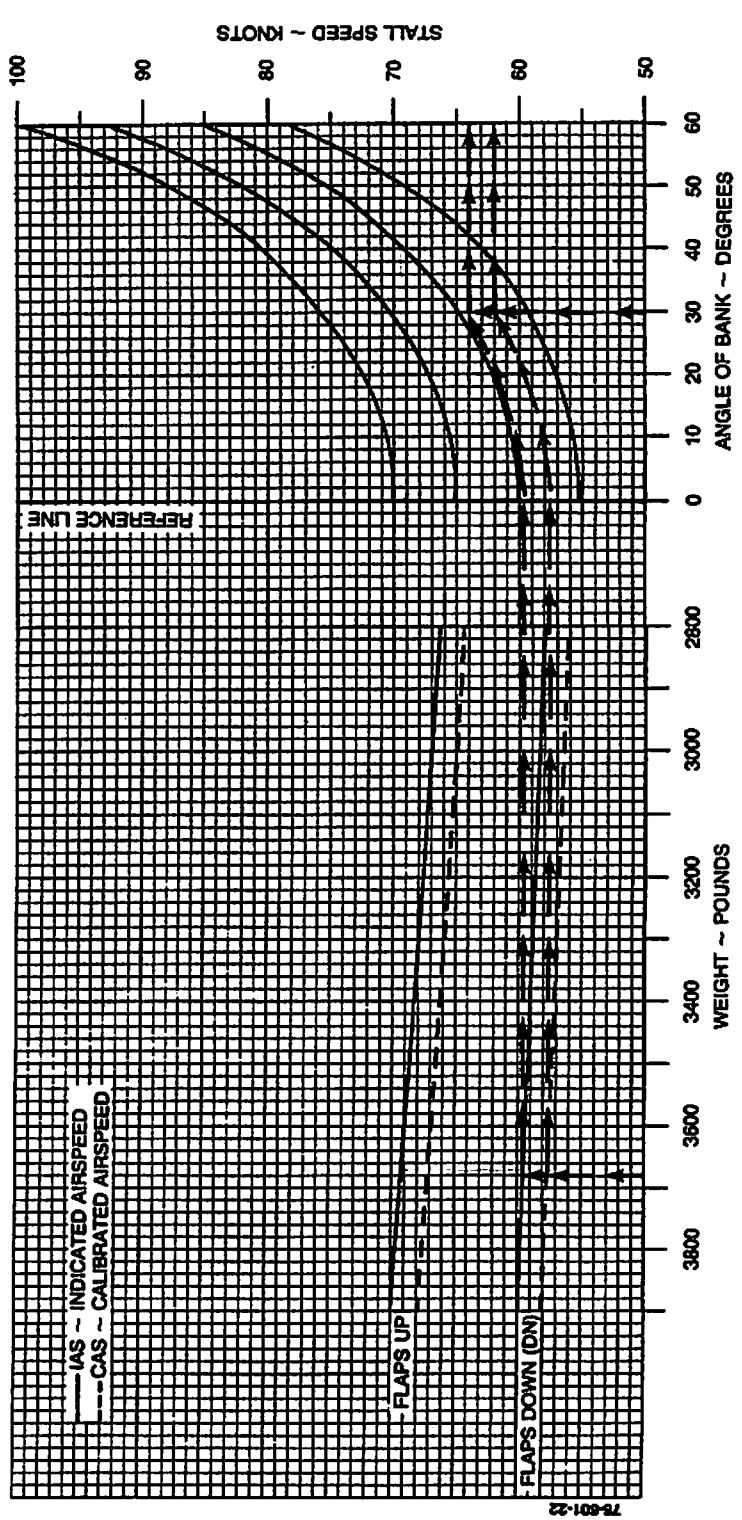

**WIND COMPONENTS
Demonstrated Crosswind is 25 kts**

EXAMPLE:

| | |
|--|-----------|
| WIND SPEED | 10 KNOTS |
| ANGLE BETWEEN WIND DIRECTION AND FLIGHT PATH | 20° |
| HEADWIND COMPONENT | 9.5 KNOTS |
| CROSSWIND COMPONENT | 3.5 KNOTS |
| FLIGHT PATH | |

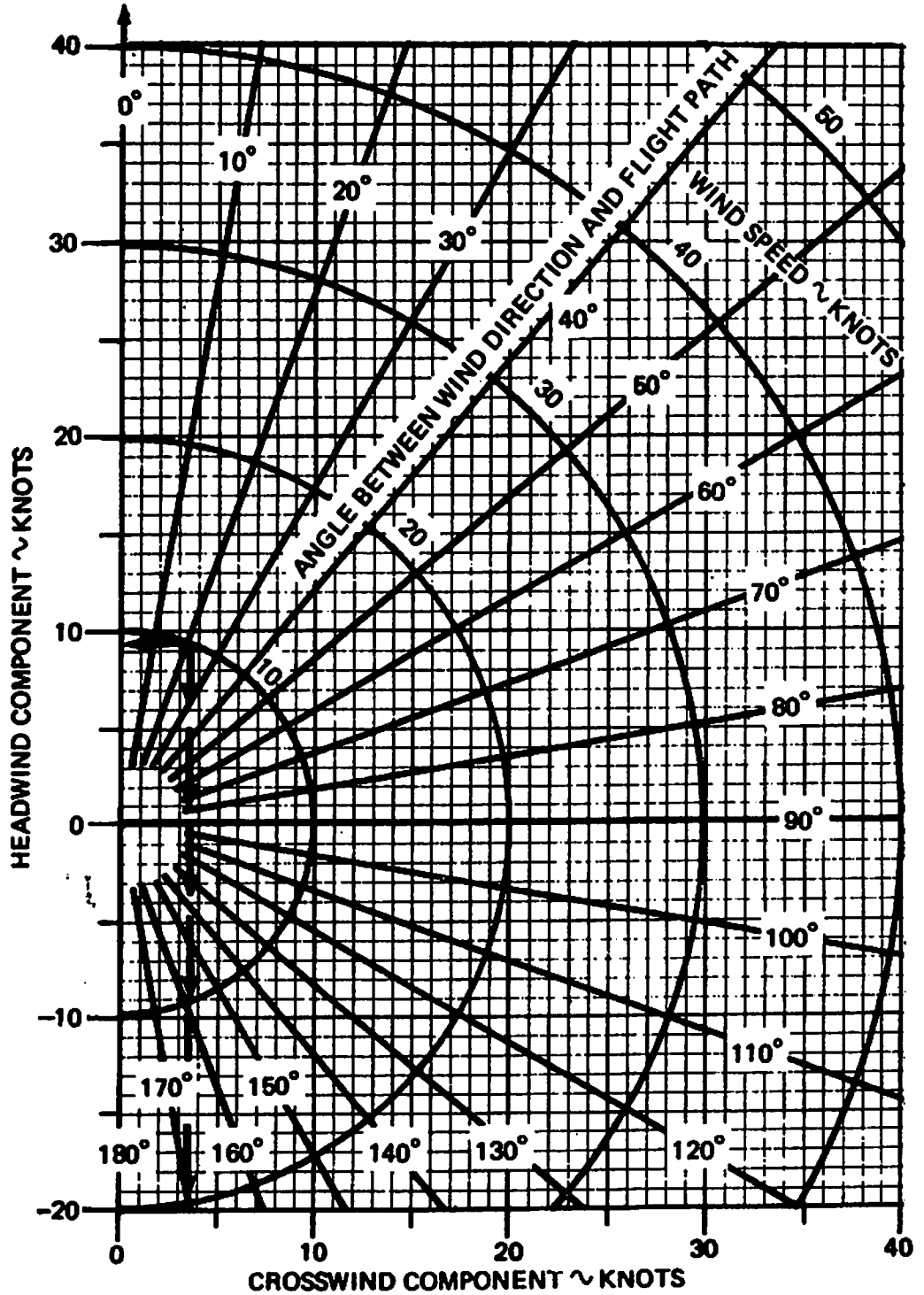

TAKE-OFF DISTANCE

ASSOCIATED CONDITIONS:

POWER TAKE-OFF POWER AT 2700 RPM SET BEFORE BRAKE RELEASE
 MIXTURE FULL RICH (ABOVE 5000 FT LEAN TO 75°-100° F ON RICH SIDE OF PEAK EGT)
 FLAPS UP
 LANDING GEAR RETRACT AFTER POSITIVE CLIMB ESTABLISHED
 RUNWAY PAVED, LEVEL, DRY SURFACE
 COWL FLAPS OPEN

| TAKE-OFF SPEEDS (ALL WEIGHTS) | |
|----------------------------------|----------|
| LIFT-OFF | 71 KNOTS |
| 50 FEET | 80 KNOTS |

EXAMPLE:

OAT 15°C
 PRESSURE ALTITUDE 5650 FT
 TAKE-OFF WEIGHT 3900 LBS
 HEADWIND COMPONENT 9.5 KTS

GROUND ROLL 1680 FT
 TOTAL DISTANCE OVER 50-FT OBSTACLE 3670 FT

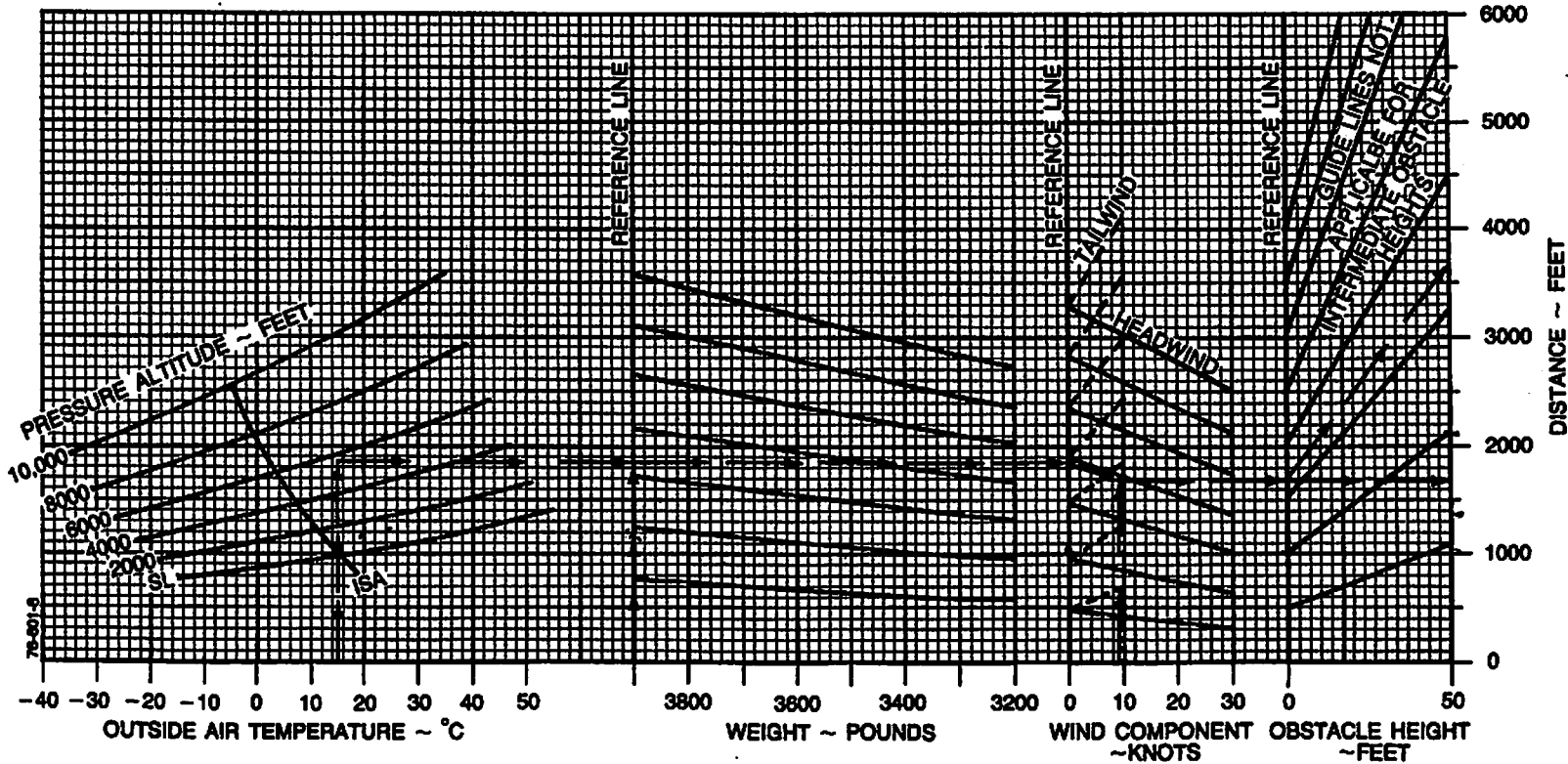

TAKE-OFF DISTANCE - GRASS SURFACE

ASSOCIATED CONDITIONS:

- POWER TAKE-OFF AT 2700 RPM SET BEFORE BRAKE RELEASE
- FLAPS UP
- LANDING GEAR RETRACT AFTER POSITIVE CLIMB ESTABLISHED
- RUNWAY SHORT, DRY GRASS, LEVEL SURFACE
- COWL FLAPS OPEN
- MIXTURE FULL RICH (ABOVE 5000 FT LEAN TO 75° - 100°F ON RICH SIDE OF PEAK EGT)

| TAKE-OFF SPEEDS (ALL WEIGHTS) | |
|----------------------------------|----------|
| LIFT-OFF | 71 KNOTS |
| 50 FEET | 80 KNOTS |

EXAMPLE:

- OAT 15°C
 - PRESSURE ALTITUDE 5650 FT
 - TAKE-OFF WEIGHT 3900 LBS
 - HEADWIND COMPONENT 9.5 KTS
-
- GROUND ROLL 1850 FT
 - TOTAL DISTANCE OVER 50 FT OBSTACLE 3650 FT
 - TAKE-OFF SPEED: AT LIFT-OFF 71 KTS
 - AT 50 FT 80 KTS

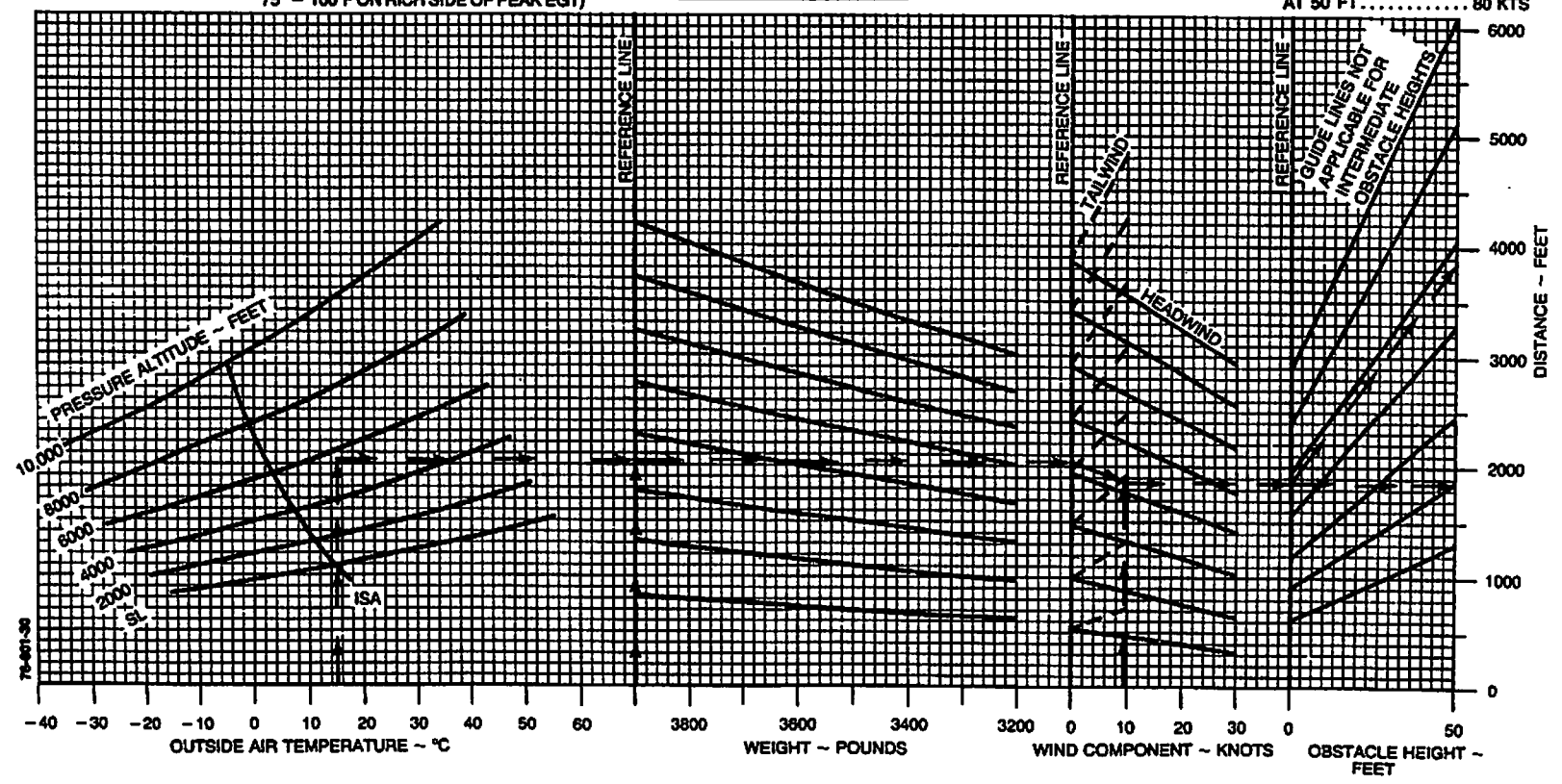

BEECHCRAFT
Duchess 76

Section V
Performance

ACCELERATE - STOP DISTANCE

DECISION SPEED 71 KNOTS (ALL WEIGHTS)

ASSOCIATED CONDITIONS:

- POWER..... 1. TAKE-OFF POWER AT 2700 RPM
SET BEFORE BRAKE RELEASE
- FLAPS..... UP
- RUNWAY..... PAVED, LEVEL, DRY SURFACE
- COWL FLAPS..... OPEN
- MIXTURE..... FULL RICH (ABOVE 5000 FT LEAN TO
75° - 100°F ON RICH SIDE OF PEAK EGT)
- 2. ENGINE IDLE AT DECISION SPEED

EXAMPLE:

- OAT..... 15°C
- PRESSURE ALTITUDE..... 5650 FT
- TAKE-OFF WEIGHT..... 3900 LBS
- HEADWIND COMPONENT..... 9.5 KTS
- ACCELERATE AND STOP DISTANCE..... 3250 FT
- DECISION SPEED..... 71 KTS

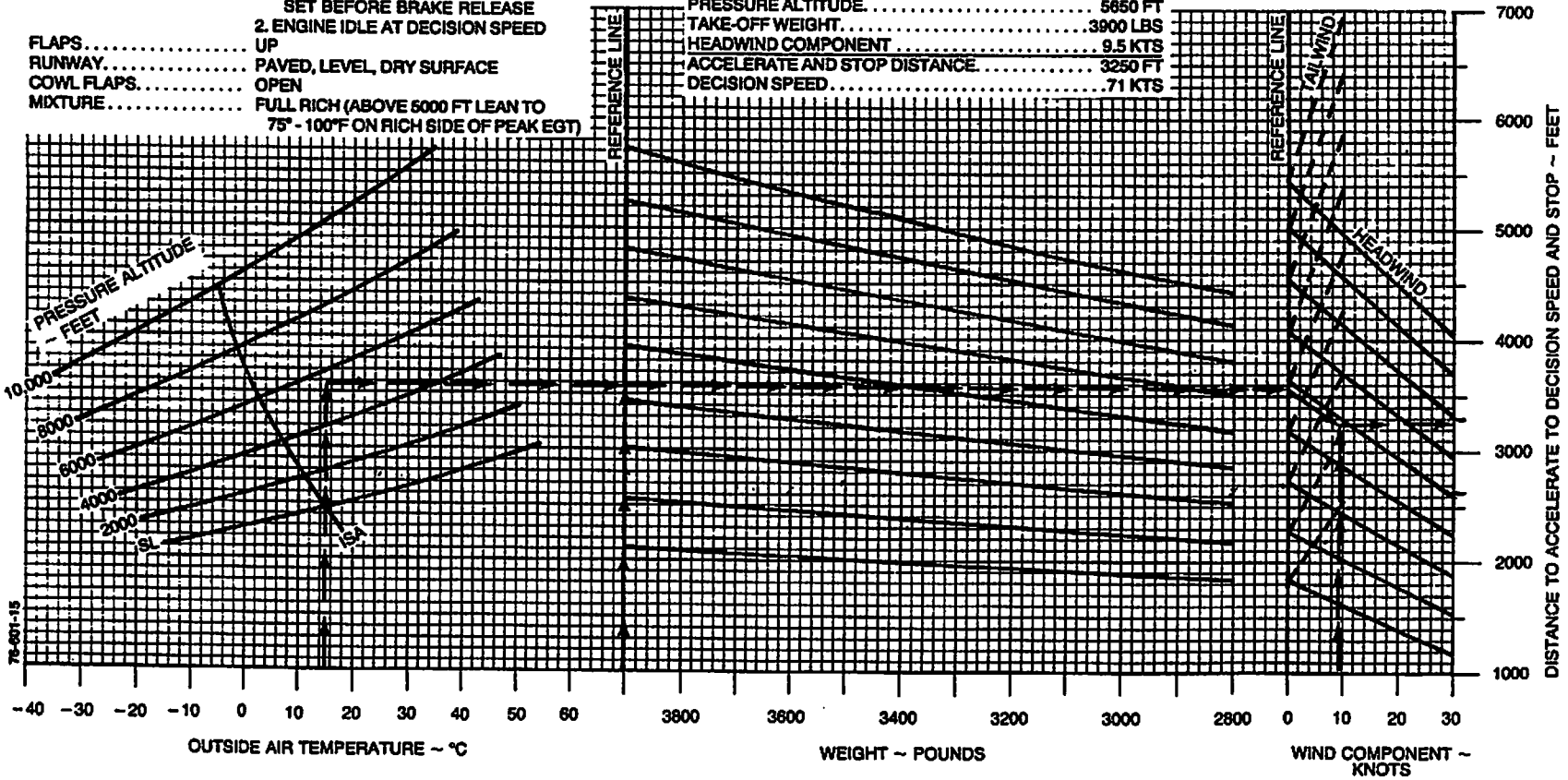

ACCELERATE-GO DISTANCE

ASSOCIATED CONDITIONS:

POWER TAKE-OFF POWER AT 2700 RPM.
 SET BEFORE BRAKE RELEASE.
 FLAPS UP
 LANDING GEAR RETRACT AFTER LIFT-OFF.
 RUNWAY PAVED, LEVEL, DRY SURFACE.
 COWL FLAPS OPEN
 MIXTURE FULL RICH (ABOVE 5000 FT, SET TO
 75-100°F ON RICH SIDE OF PEAK EGT)

| TAKE-OFF SPEEDS (ALL WEIGHTS) | |
|----------------------------------|----------|
| LIFT-OFF | 71 KNOTS |
| 50 FT | 80 KNOTS |

EXAMPLE:

OAT 15°C
 PRESSURE ALTITUDE SL
 TAKE-OFF WEIGHT 3350 LBS
 HEADWIND COMPONENT 10 KTS

TOTAL DISTANCE OVER
 50-FT OBSTACLE 4700 FT
 GROUND ROLL 940 FT

- NOTE: 1. GROUND ROLL DISTANCE IS 20% OF TAKE-OFF DISTANCE OVER 50-FT OBSTACLE.
 2. DISTANCES ASSUME AN ENGINE FAILURE AT LIFT-OFF AND PROPELLER IMMEDIATELY FEATHERED.
 3. WEIGHTS IN SHADED AREA MAY NOT PROVIDE POSITIVE ONE-ENGINE-INOPERATIVE CLIMB. REFER TO TAKE-OFF WEIGHT GRAPH FOR MAXIMUM WEIGHT AT WHICH THE ACCELERATE-GO PROCEDURE SHOULD BE ATTEMPTED.

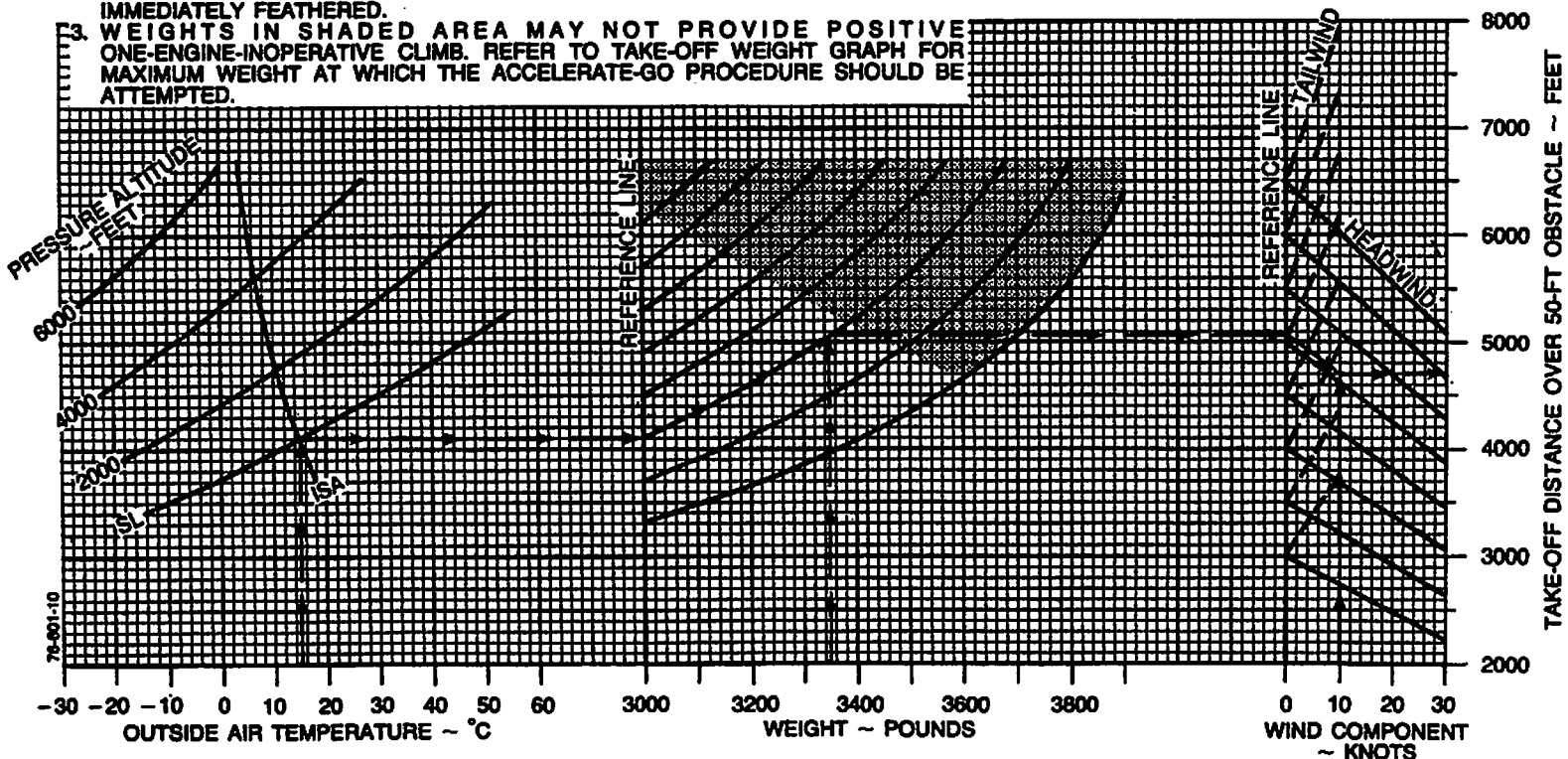

CLIMB - TWO ENGINE

CLIMB SPEED 85 KNOTS (ALL WEIGHTS)

ASSOCIATED CONDITIONS:

POWER..... MAXIMUM CONTINUOUS AT 2700 RPM
 FLAPS..... UP
 LANDING GEAR..... UP
 COWL FLAPS..... OPEN
 MIXTURE..... FULL RICH (ABOVE 5000 FT LEAN TO
 75° - 100°F ON RICH SIDE OF PEAK EGT)

EXAMPLE:

OAT.....10°C
 PRESSURE ALTITUDE.....11,500 FT
 WEIGHT.....3880 LBS

 RATE OF CLIMB.....500 FT/MIN
 CLIMB GRADIENT.....4.6%

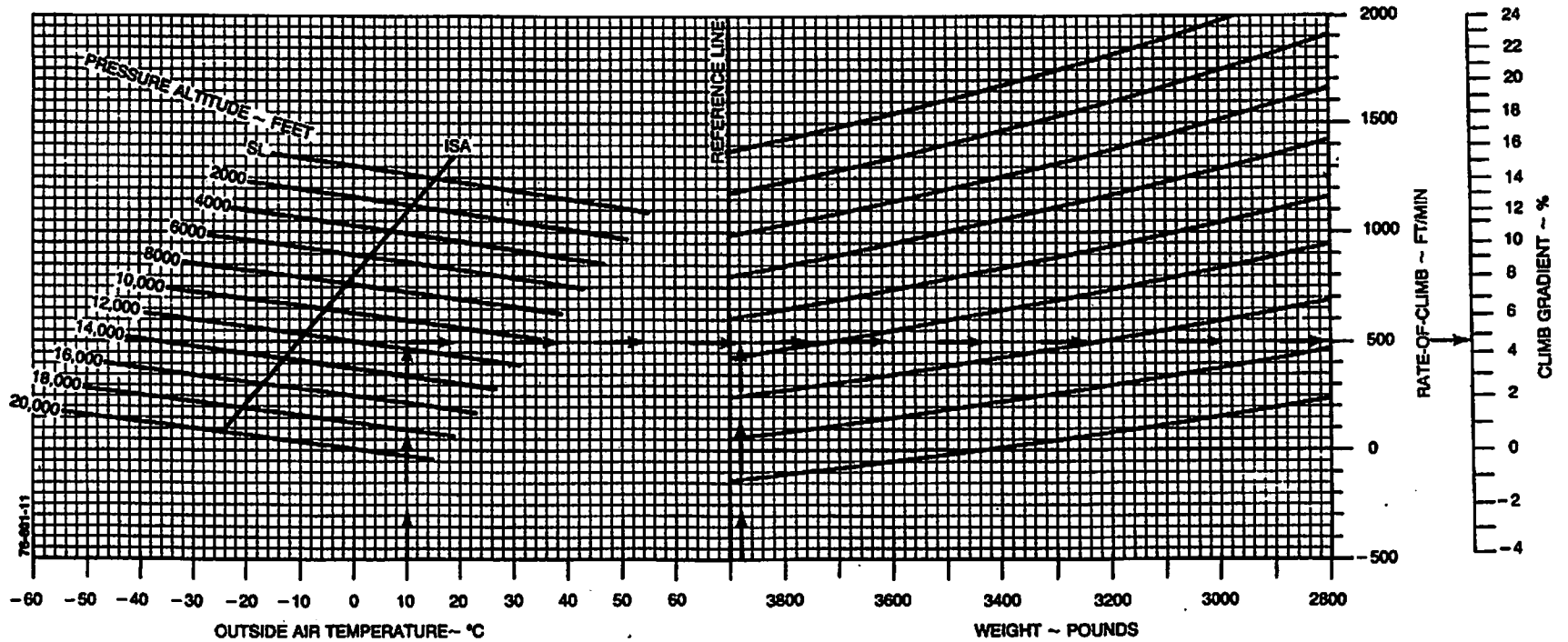

TAKE-OFF CLIMB GRADIENT – ONE ENGINE INOPERATIVE

CLIMB SPEED 80 KNOTS (ALL WEIGHTS)

ASSOCIATED CONDITIONS:

POWER TAKE-OFF AT 2700 RPM
 LANDING GEAR UP
 FLAPS UP
 INOPERATIVE PROPELLER FEATHERED
 COWL FLAPS OPEN
 MIXTURE FULL RICH (ABOVE 5000 FT LEAN TO 75-100° F ON RICH SIDE OF PEAK EGT)

EXAMPLE:

OAT 15°C
 PRESSURE ALTITUDE SL
 WEIGHT 3350 LBS

 GRADIENT OF CLIMB 4.6%

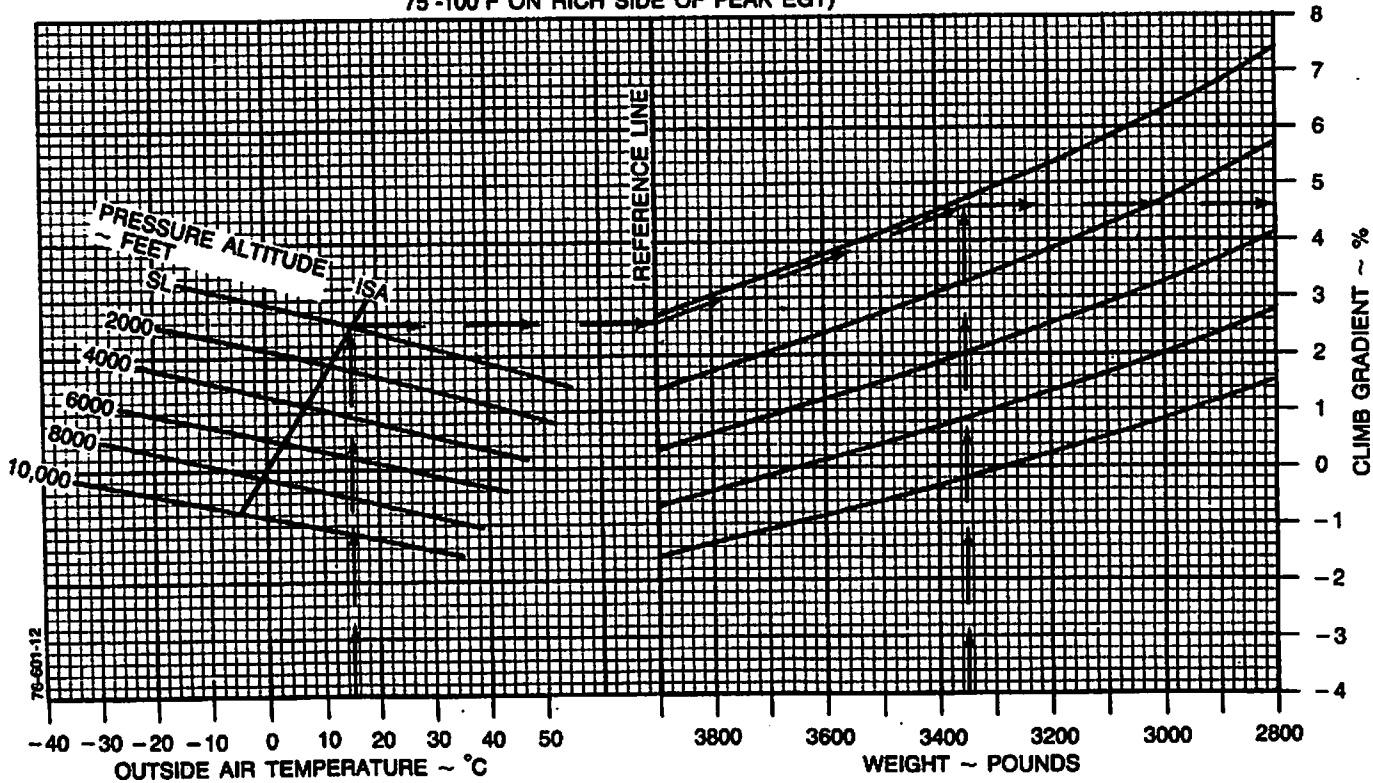

TIME, FUEL, AND DISTANCE TO CLIMB

CLIMB SPEED 100 KNOTS

ASSOCIATED CONDITIONS:

POWER..... FULL THROTTLE AT
 2600 RPM
 FUEL DENSITY..... 8.0-LBS/GAL
 COWL FLAPS..... OPEN
 MIXTURE..... FULL RICH (ABOVE 5000 FT LEAN TO
 75° - 100°F ON RICH SIDE OF PEAK EGT)

EXAMPLE:

OAT AT TAKE-OFF..... 15°C
 OAT AT CRUISE..... -5°C
 AIRPORT PRESSURE ALTITUDE..... 5650 FT
 CRUISE PRESSURE ALTITUDE..... 11,500 FT
 INITIAL CLIMB WEIGHT..... 3900 LBS

TIME TO CLIMB..... 14 - 6 = 8 MINUTES
 FUEL TO CLIMB..... 6.1 - 2.8 = 3.3 GAL
 DISTANCE TO CLIMB..... 24 - 10 = 14 NM

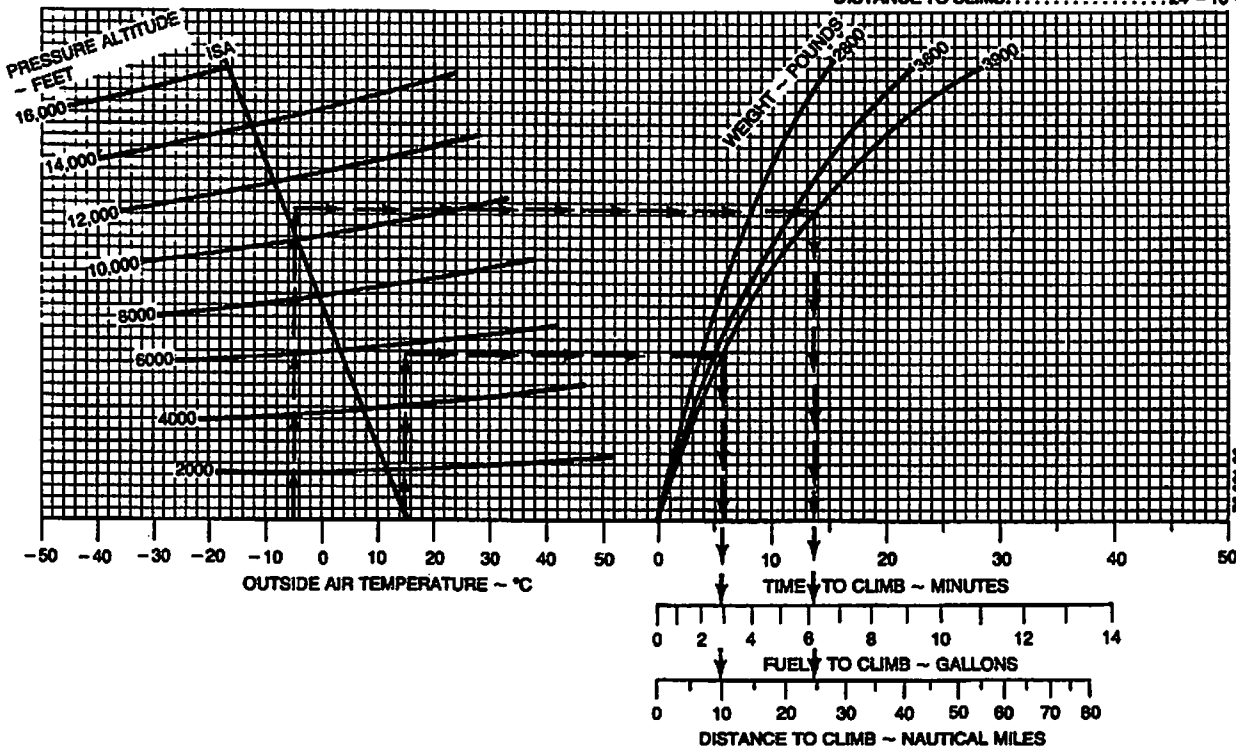

**CLIMB - ONE ENGINE INOPERATIVE
CLIMB SPEED 85 KNOTS (ALL WEIGHTS)**

ASSOCIATED CONDITIONS:

POWER..... TAKE-OFF AT 2700 RPM
 LANDING GEAR..... UP
 FLAPS..... UP
 INOPERATIVE PROPELLER - FEATHERED
 COWL FLAPS..... OPEN
 MIXTURE..... FULL RICH (ABOVE 5000 FT LEAN TO
 75° - 100°F ON RICH SIDE OF PEAK EGT)

EXAMPLE:

OAT..... 25°C
 PRESSURE ALTITUDE..... 3965 FT
 WEIGHT..... 3677 LBS
 RATE OF CLIMB..... 140 FT/MIN
 CLIMB GRADIENT..... 1.5%
 CLIMB SPEED..... 85 KTS

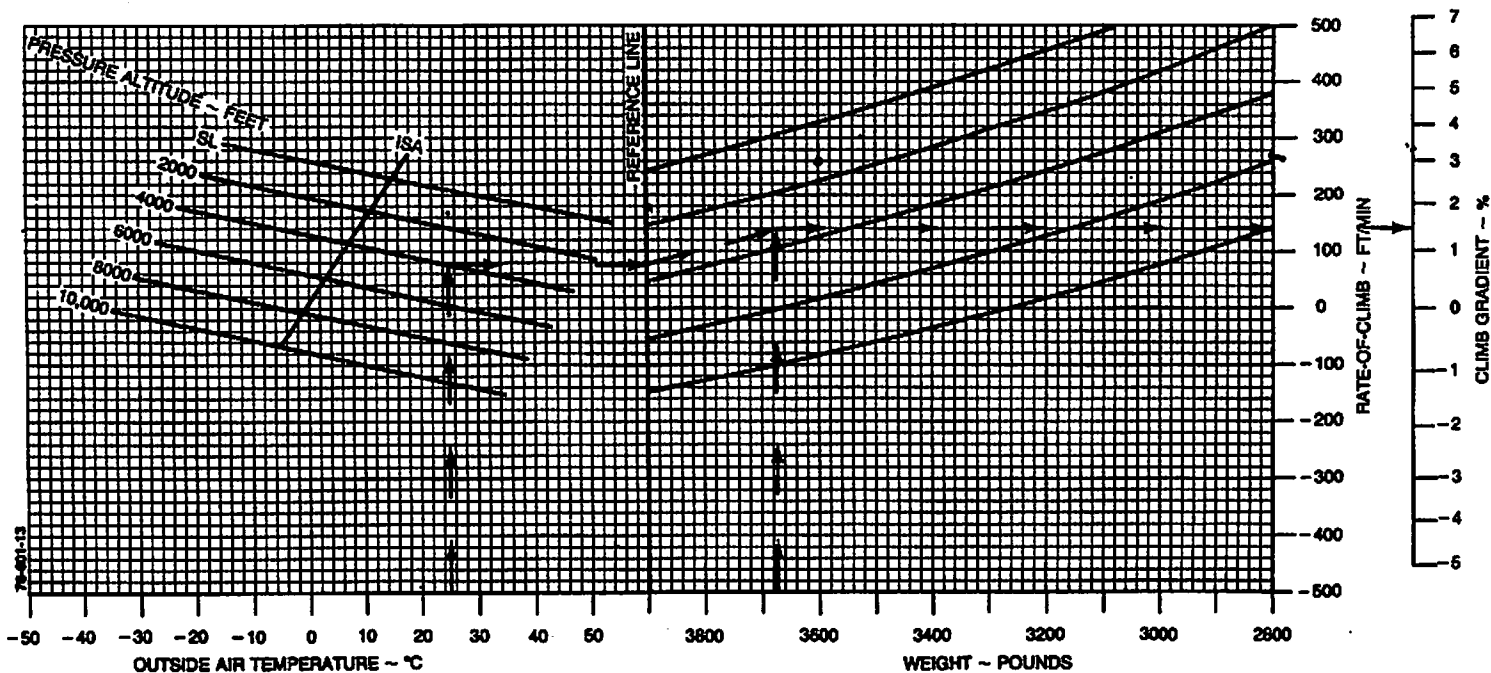

**SERVICE CEILING - ONE ENGINE INOPERATIVE
CLIMB SPEED - 85 KNOTS (ALL WEIGHTS)**

ASSOCIATED CONDITIONS:

POWER.....MAXIMUM
CONTINUOUS
AT 2700 RPM
FLAPS.....UP
LANDING GEAR.....UP
INOPERATIVE PROPELLER... FEATHERED

EXAMPLE:

OAT AT MEA.....-5°C
ROUTE SEGMENT MEA.....9700 FT

WEIGHT FOR SERVICE CEILING
AT ROUTE SEGMENT MEA.....3480 LBS

**NOTE: SERVICE CEILING IS ALTITUDE WHERE AIRPLANE HAS CAPABILITY
OF CLIMBING 50 FT/MIN WITH ONE PROPELLER FEATHERED.**

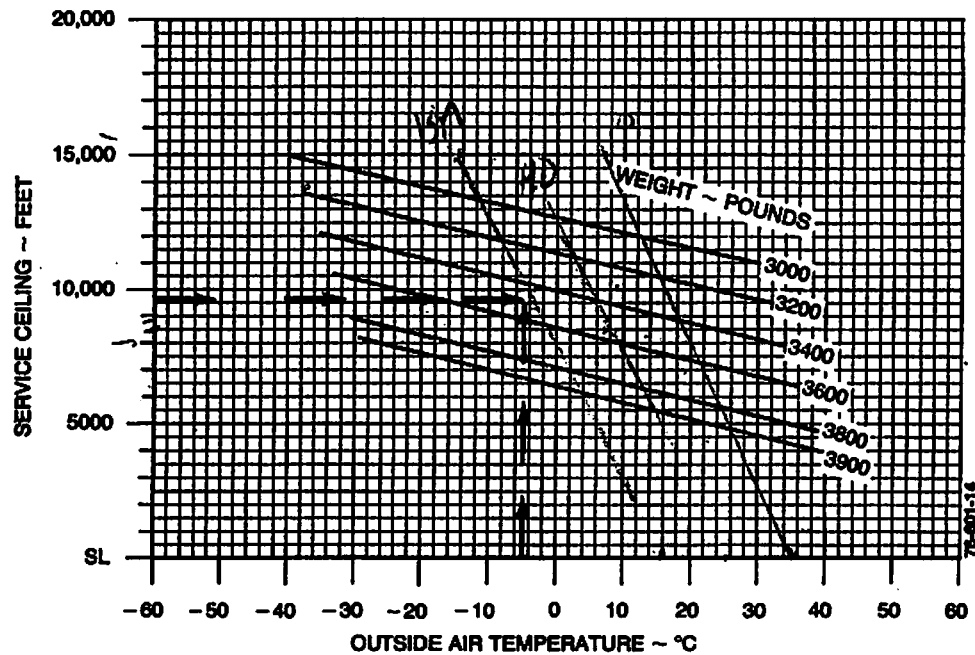

CRUISE SPEEDS

ASSOCIATED CONDITIONS:

AVERAGE CRUISE WEIGHT . . . 3600 LBS
TEMPERATURE STD DAY (ISA)

EXAMPLE:

PRESSURE ALTITUDE . . . 6000 FT
POWER SETTING 20 IN.HG/2300 RPM

TRUE AIRSPEED 139.5 KTS

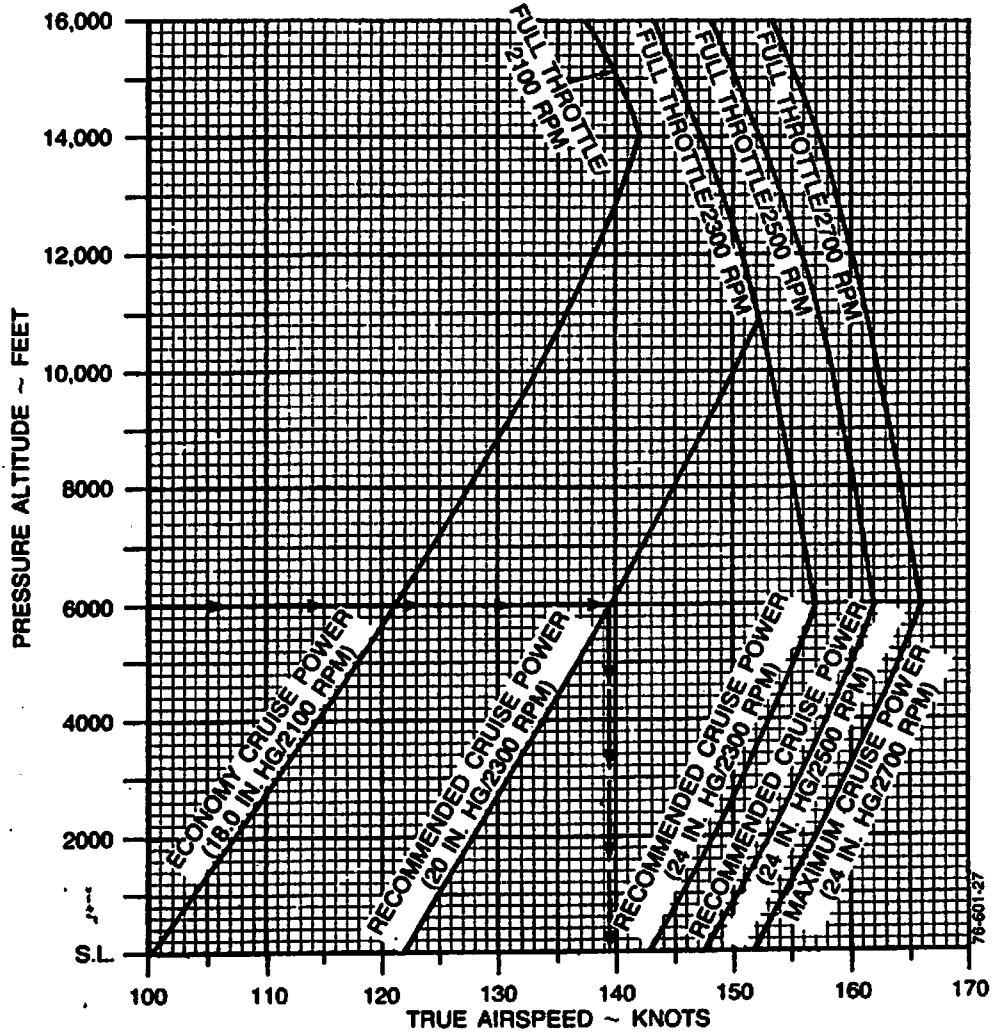

MAXIMUM CRUISE POWER - 24.0 IN. HG @ 2700 RPM (OR FULL THROTTLE)

| PRESS ALT | ISA - 20°C (-36°F) | | | | | | STANDARD DAY (ISA) | | | | | | ISA + 20°C (+36°F) | | | | | | | | |
|--------------|--------------------|-----|---------------|-------------------------|------|-----|--------------------|------|----|---------------|-------------------------|------|--------------------|-----|------|----|---------------|-------------------------|------|-----|-----|
| | IOAT | | MAN. PRESS | FUEL FLOW/ ENGINE | | IAS | TAS | IOAT | | MAN. PRESS | FUEL FLOW/ ENGINE | | IAS | TAS | IOAT | | MAN. PRESS | FUEL FLOW/ ENGINE | | IAS | TAS |
| | °C | °F | IN.HG | PPH | GPH | KTS | KTS | °C | °F | IN.HG | PPH | GPH | KTS | KTS | °C | °F | IN.HG | PPH | GPH | KTS | KTS |
| SL | -3 | 27 | 24.0 | 67 | 11.1 | 156 | 151 | 17 | 63 | 24.0 | 65 | 10.8 | 152 | 152 | 37 | 99 | 24.0 | 62 | 10.3 | 148 | 153 |
| 1000 | -5 | 23 | 24.0 | 68 | 11.3 | 156 | 153 | 15 | 59 | 24.0 | 65 | 10.8 | 152 | 155 | 35 | 95 | 24.0 | 63 | 10.5 | 148 | 156 |
| 2000 | -7 | 19 | 24.0 | 68 | 11.3 | 156 | 155 | 13 | 55 | 24.0 | 66 | 11.0 | 152 | 157 | 33 | 91 | 24.0 | 63 | 10.5 | 148 | 158 |
| 3000 | -9 | 16 | 24.0 | 69 | 11.5 | 156 | 158 | 11 | 52 | 24.0 | 66 | 11.0 | 152 | 159 | 31 | 88 | 24.0 | 64 | 10.7 | 148 | 161 |
| 4000 | -11 | 12 | 24.0 | 69 | 11.5 | 157 | 160 | 9 | 48 | 24.0 | 67 | 11.2 | 153 | 162 | 30 | 86 | 24.0 | 65 | 10.8 | 149 | 163 |
| 5000 | -12 | 10 | 24.0 | 70 | 11.7 | 157 | 163 | 8 | 46 | 24.0 | 68 | 11.3 | 153 | 164 | 28 | 82 | 24.0 | 65 | 10.8 | 148 | 165 |
| 6000 | -14 | 7 | 23.5 | 70 | 11.7 | 156 | 164 | 6 | 43 | 23.5 | 68 | 11.3 | 152 | 166 | 26 | 79 | 23.5 | 65 | 10.8 | 148 | 167 |
| 7000 | -16 | 3 | 22.6 | 68 | 11.3 | 153 | 164 | 4 | 39 | 22.6 | 65 | 10.8 | 149 | 165 | 24 | 75 | 22.6 | 63 | 10.5 | 145 | 166 |
| 8000 | -18 | 0 | 21.8 | 65 | 10.8 | 150 | 163 | 2 | 36 | 21.8 | 63 | 10.5 | 146 | 164 | 22 | 72 | 21.8 | 61 | 10.2 | 142 | 165 |
| 9000 | -20 | -4 | 20.9 | 63 | 10.5 | 147 | 162 | 0 | 32 | 20.9 | 61 | 10.2 | 143 | 163 | 20 | 68 | 20.9 | 59 | 9.8 | 139 | 164 |
| 10,000 | -22 | -8 | 20.2 | 61 | 10.2 | 144 | 161 | -2 | 28 | 20.2 | 59 | 9.8 | 140 | 162 | 18 | 64 | 20.2 | 57 | 9.5 | 135 | 163 |
| 11,000 | -24 | -11 | 19.4 | 59 | 9.8 | 141 | 160 | -4 | 25 | 19.4 | 57 | 9.5 | 136 | 161 | 16 | 61 | 19.4 | 55 | 9.2 | 132 | 162 |
| 12,000 | -26 | -15 | 18.6 | 56 | 9.3 | 138 | 159 | -6 | 21 | 18.6 | 54 | 9.0 | 133 | 160 | 14 | 57 | 18.6 | 53 | 8.8 | 129 | 161 |
| 13,000 | -28 | -18 | 17.9 | 54 | 9.0 | 134 | 157 | -8 | 18 | 17.9 | 52 | 8.7 | 130 | 158 | 12 | 54 | 17.9 | 50 | 8.3 | 126 | 159 |
| 14,000 | -31 | -24 | 17.2 | 52 | 8.7 | 131 | 156 | -10 | 14 | 17.2 | 50 | 8.3 | 127 | 157 | 10 | 50 | 17.2 | 48 | 8.0 | 122 | 157 |
| 15,000 | -33 | -27 | 16.6 | 50 | 8.3 | 127 | 154 | -12 | 10 | 16.6 | 48 | 8.0 | 123 | 155 | 8 | 46 | 16.6 | 47 | 7.8 | 119 | 155 |
| 16,000 | -35 | -31 | 15.9 | 48 | 8.0 | 124 | 152 | -15 | 5 | 15.9 | 46 | 7.7 | 120 | 153 | 6 | 43 | 15.9 | 45 | 7.5 | 115 | 153 |

- NOTES: 1. Full throttle manifold pressure settings are approximate.
 2. Shaded area represents operation with full throttle.
 3. Lean to 25° - 50°F on rich side of peak EGT.
 4. Cruise speeds are presented at an average weight of 3600 lbs.

RECOMMENDED CRUISE POWER - 24.0 IN. HG @ 2500 RPM (OR FULL THROTTLE)

| PRESS ALT FEET | ISA -20°C (-36°F) | | | | | | | STANDARD DAY (ISA) | | | | | | | ISA +20°C (+36°F) | | | | | | |
|----------------------|-------------------|-----|---------------|-------------------------|------|-----|-----|--------------------|----|---------------|-------------------------|------|-----|-----|-------------------|----|---------------|-------------------------|------|-----|-----|
| | IOAT | | MAN. PRESS | FUEL FLOW/ ENGINE | | IAS | TAS | IOAT | | MAN. PRESS | FUEL FLOW/ ENGINE | | IAS | TAS | IOAT | | MAN. PRESS | FUEL FLOW/ ENGINE | | IAS | TAS |
| | °C | °F | IN.HG | PPH | GPH | KTS | KTS | °C | °F | IN.HG | PPH | GPH | KTS | KTS | °C | °F | IN.HG | PPH | GPH | KTS | KTS |
| SL | -3 | 27 | 24.0 | 61 | 10.2 | 152 | 147 | 17 | 63 | 24.0 | 59 | 9.8 | 148 | 148 | 37 | 99 | 24.0 | 57 | 9.5 | 144 | 149 |
| 1000 | -5 | 23 | 24.0 | 62 | 10.3 | 152 | 149 | 15 | 59 | 24.0 | 60 | 10.0 | 148 | 151 | 35 | 95 | 24.0 | 58 | 9.7 | 144 | 151 |
| 2000 | -7 | 19 | 24.0 | 63 | 10.5 | 153 | 152 | 13 | 55 | 24.0 | 61 | 10.2 | 148 | 153 | 33 | 91 | 24.0 | 58 | 9.7 | 144 | 154 |
| 3000 | -9 | 16 | 24.0 | 64 | 10.7 | 153 | 154 | 11 | 52 | 24.0 | 61 | 10.2 | 149 | 155 | 31 | 88 | 24.0 | 59 | 9.8 | 144 | 156 |
| 4000 | -11 | 12 | 24.0 | 64 | 10.7 | 153 | 156 | 9 | 48 | 24.0 | 62 | 10.3 | 149 | 158 | 29 | 84 | 24.0 | 60 | 10.0 | 144 | 159 |
| 5000 | -13 | 9 | 24.0 | 65 | 10.8 | 153 | 159 | 7 | 45 | 24.0 | 63 | 10.5 | 149 | 160 | 28 | 82 | 24.0 | 61 | 10.2 | 144 | 161 |
| 6000 | -15 | 5 | 23.6 | 66 | 11.0 | 153 | 161 | 6 | 43 | 23.6 | 63 | 10.5 | 148 | 162 | 26 | 79 | 23.6 | 61 | 10.2 | 144 | 163 |
| 7000 | -17 | 1 | 22.7 | 63 | 10.5 | 150 | 160 | 4 | 39 | 22.7 | 61 | 10.2 | 145 | 161 | 24 | 75 | 22.7 | 59 | 9.8 | 141 | 162 |
| 8000 | -19 | -2 | 21.9 | 61 | 10.2 | 146 | 159 | 2 | 36 | 21.9 | 59 | 9.8 | 142 | 160 | 22 | 72 | 21.9 | 57 | 9.5 | 138 | 161 |
| 9000 | -21 | -6 | 21.0 | 59 | 9.8 | 143 | 158 | 0 | 32 | 21.0 | 57 | 9.5 | 139 | 159 | 20 | 68 | 21.0 | 55 | 9.2 | 135 | 160 |
| 10,000 | -23 | -9 | 20.2 | 57 | 9.5 | 140 | 157 | -3 | 27 | 20.2 | 55 | 9.2 | 136 | 158 | 18 | 64 | 20.2 | 53 | 8.8 | 132 | 159 |
| 11,000 | -25 | -13 | 19.4 | 55 | 9.2 | 137 | 156 | -5 | 23 | 19.4 | 53 | 8.8 | 133 | 157 | 16 | 61 | 19.4 | 51 | 8.5 | 129 | 158 |
| 12,000 | -27 | -17 | 18.7 | 53 | 8.8 | 134 | 155 | -7 | 19 | 18.7 | 51 | 8.5 | 130 | 156 | 14 | 57 | 18.7 | 49 | 8.2 | 125 | 156 |
| 13,000 | -29 | -20 | 18.0 | 51 | 8.5 | 131 | 153 | -9 | 16 | 18.0 | 49 | 8.2 | 126 | 154 | 11 | 52 | 18.0 | 47 | 7.8 | 122 | 155 |
| 14,000 | -31 | -24 | 17.3 | 49 | 8.2 | 127 | 152 | -11 | 12 | 17.3 | 47 | 7.8 | 123 | 152 | 9 | 48 | 17.3 | 45 | 7.5 | 118 | 153 |
| 15,000 | -33 | -27 | 16.6 | 47 | 7.8 | 124 | 150 | -13 | 9 | 16.6 | 45 | 7.5 | 120 | 151 | 7 | 45 | 16.6 | 44 | 7.3 | 115 | 151 |
| 16,000 | -35 | -31 | 16.0 | 45 | 7.5 | 121 | 148 | -15 | 5 | 16.0 | 43 | 7.2 | 116 | 148 | 5 | 41 | 16.0 | 42 | 7.0 | 111 | 148 |

- NOTES: 1. Full throttle manifold pressure settings are approximate.
 2. Shaded area represents operation with full throttle.
 3. Lean to 25° - 50°F on rich side of peak EGT.
 4. Cruise speeds are presented at an average weight of 3600 lbs.

RECOMMENDED CRUISE POWER - 24.0 IN. HG @ 2300 RPM (OR FULL THROTTLE)

| PRESS ALT | ISA -20°C (-36°F) | | | | | | | STANDARD DAY (ISA) | | | | | | | ISA +20°C (+36°F) | | | | | | |
|--------------|-------------------|-----|---------------|------------------|------|-----|-----|--------------------|----|---------------|---------------|-----|-----|-----|-------------------|----|---------------|---------------|-----|-----|-----|
| | IOAT | | MAN. PRESS | FUEL FLOW/--- | | IAS | TAS | IOAT | | MAN. PRESS | FUEL FLOW/ | | IAS | TAS | IOAT | | MAN. PRESS | FUEL FLOW/ | | IAS | TAS |
| | FEET | °C | °F | IN.HG | PPH | GPH | KTS | KTS | °C | °F | IN.HG | PPH | GPH | KTS | KTS | °C | °F | IN.HG | PPH | GPH | KTS |
| SL | -3 | 27 | 24.0 | 55 | 9.2 | 147 | 142 | 17 | 63 | 24.0 | 53 | 8.8 | 143 | 143 | 37 | 99 | 24.0 | 51 | 8.5 | 139 | 144 |
| 1000 | -5 | 23 | 24.0 | 56 | 9.3 | 147 | 144 | 15 | 59 | 24.0 | 54 | 9.0 | 143 | 145 | 35 | 95 | 24.0 | 52 | 8.7 | 139 | 146 |
| 2000 | -7 | 19 | 24.0 | 57 | 9.5 | 148 | 147 | 13 | 55 | 24.0 | 55 | 9.2 | 143 | 148 | 33 | 91 | 24.0 | 53 | 8.8 | 139 | 149 |
| 3000 | -9 | 16 | 24.0 | 58 | 9.7 | 148 | 149 | 11 | 52 | 24.0 | 56 | 9.3 | 144 | 150 | 31 | 88 | 24.0 | 54 | 9.0 | 139 | 151 |
| 4000 | -11 | 12 | 24.0 | 59 | 9.8 | 148 | 152 | 9 | 48 | 24.0 | 57 | 9.5 | 144 | 153 | 29 | 84 | 24.0 | 55 | 9.2 | 140 | 153 |
| 5000 | -13 | 9 | 24.0 | 60 | 10.0 | 148 | 154 | 7 | 45 | 24.0 | 58 | 9.7 | 144 | 155 | 27 | 81 | 24.0 | 56 | 9.3 | 140 | 156 |
| 6000 | -15 | 5 | 23.7 | 61 | 10.2 | 148 | 156 | 5 | 41 | 23.7 | 59 | 9.8 | 144 | 157 | 25 | 77 | 23.7 | 57 | 9.5 | 140 | 158 |
| 7000 | -17 | 1 | 22.8 | 59 | 9.8 | 145 | 155 | 3 | 37 | 22.8 | 57 | 9.5 | 141 | 156 | 23 | 73 | 22.8 | 55 | 9.2 | 137 | 157 |
| 8000 | -19 | -2 | 21.9 | 57 | 9.5 | 142 | 154 | 1 | 34 | 21.9 | 55 | 9.2 | 138 | 155 | 21 | 70 | 21.9 | 53 | 8.8 | 134 | 156 |
| 9000 | -21 | -6 | 21.1 | 55 | 9.2 | 139 | 153 | -1 | 30 | 21.1 | 53 | 8.8 | 135 | 154 | 19 | 66 | 21.1 | 51 | 8.5 | 131 | 155 |
| 10,000 | -23 | -9 | 20.3 | 53 | 8.8 | 136 | 152 | -3 | 27 | 20.3 | 51 | 8.5 | 132 | 153 | 17 | 63 | 20.3 | 49 | 8.2 | 127 | 154 |
| 11,000 | -25 | -13 | 19.5 | 51 | 8.5 | 133 | 151 | -5 | 23 | 19.5 | 49 | 8.2 | 129 | 152 | 15 | 59 | 19.5 | 47 | 7.8 | 124 | 152 |
| 12,000 | -27 | -17 | 18.8 | 49 | 8.2 | 130 | 150 | -7 | 19 | 18.8 | 47 | 7.8 | 125 | 151 | 13 | 55 | 18.8 | 46 | 7.7 | 121 | 151 |
| 13,000 | -29 | -20 | 18.0 | 47 | 7.8 | 127 | 148 | -9 | 16 | 18.0 | 46 | 7.7 | 122 | 149 | 11 | 52 | 18.0 | 44 | 7.3 | 117 | 149 |
| 14,000 | -31 | -24 | 17.3 | 45 | 7.5 | 123 | 147 | -11 | 12 | 17.3 | 44 | 7.3 | 119 | 147 | 9 | 48 | 17.3 | 42 | 7.0 | 114 | 147 |
| 15,000 | -33 | -27 | 16.7 | 44 | 7.3 | 120 | 145 | -13 | 9 | 16.7 | 42 | 7.0 | 115 | 145 | 7 | 45 | 16.7 | 41 | 6.8 | 110 | 144 |
| 16,000 | -35 | -31 | 16.0 | 42 | 7.0 | 116 | 143 | -15 | 5 | 16.0 | 40 | 6.7 | 111 | 143 | 5 | 41 | 16.0 | 39 | 6.5 | 106 | 142 |

- NOTES: 1. Full throttle manifold pressure settings are approximate.
 2. Shaded area represents operation with full throttle.
 3. Lean to 25° - 50°F on rich side of peak EGT.
 4. Cruise speeds are presented at an average weight of 3600 lbs.

January 1982

RECOMMENDED CRUISE POWER - 20.0 IN. HG @ 2300 RPM (OR FULL THROTTLE)

| PRESS ALT. | ISA -20°C (-36°F) | | | | | | | STANDARD DAY (ISA) | | | | | | | ISA +20°C (+36°F) | | | | | | |
|---------------|-------------------|-----|----------------|-------------------------|-----|-----|-----|--------------------|----|----------------|-------------------------|-----|-----|-----|-------------------|----|----------------|-------------------------|-----|-----|-----|
| | IOAT | | MAN. PRESS. | FUEL FLOW/ ENGINE | | IAS | TAS | IOAT | | MAN. PRESS. | FUEL FLOW/ ENGINE | | IAS | TAS | IOAT | | MAN. PRESS. | FUEL FLOW/ ENGINE | | IAS | TAS |
| | °C | °F | IN.HG | PPH | GPH | KTS | KTS | °C | °F | IN.HG | PPH | GPH | KTS | KTS | °C | °F | IN.HG | PPH | GPH | KTS | KTS |
| SL | -4 | 25 | 20.0 | 41 | 6.8 | 127 | 122 | 16 | 61 | 20.0 | 40 | 6.7 | 123 | 123 | 36 | 97 | 20.0 | 38 | 6.3 | 119 | 123 |
| 1000 | -6 | 21 | 20.0 | 42 | 7.0 | 128 | 125 | 14 | 57 | 20.0 | 41 | 6.8 | 124 | 126 | 34 | 93 | 20.0 | 39 | 6.5 | 120 | 126 |
| 2000 | -7 | 19 | 20.0 | 43 | 7.2 | 129 | 128 | 13 | 55 | 20.0 | 42 | 7.0 | 125 | 129 | 33 | 91 | 20.0 | 40 | 6.7 | 121 | 129 |
| 3000 | -9 | 16 | 20.0 | 44 | 7.3 | 130 | 131 | 11 | 52 | 20.0 | 42 | 7.0 | 126 | 132 | 31 | 88 | 20.0 | 41 | 6.8 | 122 | 132 |
| 4000 | -11 | 12 | 20.0 | 45 | 7.5 | 131 | 134 | 9 | 48 | 20.0 | 43 | 7.2 | 127 | 135 | 29 | 84 | 20.0 | 42 | 7.0 | 122 | 135 |
| 5000 | -13 | 9 | 20.0 | 46 | 7.7 | 131 | 136 | 7 | 45 | 20.0 | 44 | 7.3 | 127 | 137 | 27 | 81 | 20.0 | 43 | 7.2 | 123 | 137 |
| 6000 | -15 | 5 | 20.0 | 47 | 7.8 | 132 | 139 | 5 | 41 | 20.0 | 45 | 7.5 | 128 | 140 | 25 | 77 | 20.0 | 44 | 7.3 | 124 | 140 |
| 7000 | -17 | 1 | 20.0 | 48 | 8.0 | 133 | 142 | 3 | 37 | 20.0 | 46 | 7.7 | 128 | 143 | 23 | 73 | 20.0 | 45 | 7.5 | 124 | 143 |
| 8000 | -19 | -2 | 20.0 | 49 | 8.2 | 133 | 145 | 1 | 34 | 20.0 | 47 | 7.8 | 129 | 145 | 21 | 70 | 20.0 | 46 | 7.7 | 125 | 146 |
| 9000 | -21 | -6 | 20.0 | 50 | 8.3 | 134 | 147 | -1 | 30 | 20.0 | 48 | 8.0 | 129 | 148 | 19 | 66 | 20.0 | 47 | 7.8 | 125 | 149 |
| 10,000 | -23 | -9 | 20.0 | 51 | 8.5 | 134 | 150 | -3 | 27 | 20.0 | 49 | 8.2 | 130 | 151 | 17 | 63 | 20.0 | 48 | 8.0 | 125 | 151 |
| 11,000 | -25 | -13 | 19.5 | 51 | 8.5 | 133 | 151 | -5 | 23 | 19.5 | 49 | 8.2 | 129 | 152 | 15 | 59 | 19.5 | 47 | 7.8 | 124 | 152 |
| 12,000 | -27 | -17 | 18.8 | 49 | 8.2 | 130 | 150 | -7 | 19 | 18.8 | 47 | 7.8 | 125 | 151 | 13 | 55 | 18.8 | 46 | 7.7 | 121 | 151 |
| 13,000 | -29 | -20 | 18.0 | 47 | 7.8 | 127 | 148 | -9 | 16 | 18.0 | 46 | 7.7 | 122 | 149 | 11 | 52 | 18.0 | 44 | 7.3 | 117 | 149 |
| 14,000 | -31 | -24 | 17.3 | 45 | 7.5 | 123 | 147 | -11 | 12 | 17.3 | 44 | 7.3 | 119 | 147 | 9 | 48 | 17.3 | 42 | 7.0 | 114 | 147 |
| 15,000 | -33 | -27 | 16.7 | 44 | 7.3 | 120 | 145 | -13 | 9 | 16.7 | 42 | 7.0 | 115 | 145 | 7 | 45 | 16.7 | 41 | 6.8 | 110 | 144 |
| 16,000 | -35 | -31 | 16.0 | 42 | 7.0 | 116 | 143 | -15 | 5 | 16.0 | 40 | 6.7 | 111 | 143 | 5 | 41 | 16.0 | 39 | 6.5 | 106 | 142 |

- NOTES: 1. Full throttle manifold pressure settings are approximate.
 2. Shaded area represents operation with full throttle.
 3. Lean to 25° - 50°F on rich side of peak EGT.
 4. Cruise speeds are presented at an average weight of 3600 lbs.

ECONOMY CRUISE POWER - 18.0 IN. HG @ 2100 RPM (OR FULL THROTTLE)

| PRESS ALT | ISA -20°C (-36°F) | | | | | | | STANDARD DAY (ISA) | | | | | | | ISA +20°C (+36°F) | | | | | | |
|--------------|-------------------|-----|----------------|----------------------|-----|-----|-----|--------------------|----|----------------|----------------------|-----|-----|-----|-------------------|----|----------------|----------------------|-----|-----|-----|
| | IOAT | | MAN. PRESS. | FUEL FLOW/ ENG | | IAS | TAS | IOAT | | MAN. PRESS. | FUEL FLOW/ ENG | | IAS | TAS | IOAT | | MAN. PRESS. | FUEL FLOW/ ENG | | IAS | TAS |
| | FEET | °C | °F | IN.HG | PPH | GPH | KTS | KTS | °C | °F | IN.HG | PPH | GPH | KTS | KTS | °C | °F | IN.HG | PPH | GPH | KTS |
| SL | -4 | 25 | 18.0 | 29 | 4.8 | 104 | 101 | 16 | 61 | 18.0 | 28 | 4.7 | 99 | 100 | 36 | 97 | 18.0 | 27 | 4.5 | 96 | 98 |
| 1000 | -6 | 21 | 18.0 | 30 | 5.0 | 106 | 105 | 14 | 57 | 18.0 | 29 | 4.8 | 101 | 104 | 34 | 93 | 18.0 | 28 | 4.7 | 95 | 102 |
| 2000 | -8 | 18 | 18.0 | 31 | 5.2 | 107 | 108 | 12 | 54 | 18.0 | 30 | 5.0 | 103 | 107 | 32 | 90 | 18.0 | 29 | 4.8 | 98 | 106 |
| 3000 | -10 | 14 | 18.0 | 32 | 5.3 | 109 | 112 | 10 | 50 | 18.0 | 31 | 5.2 | 105 | 111 | 30 | 86 | 18.0 | 30 | 5.0 | 101 | 110 |
| 4000 | -12 | 11 | 18.0 | 34 | 5.7 | 111 | 115 | 8 | 47 | 18.0 | 32 | 5.3 | 107 | 115 | 28 | 83 | 18.0 | 31 | 5.2 | 103 | 113 |
| 5000 | -14 | 8 | 18.0 | 35 | 5.8 | 112 | 119 | 6 | 43 | 18.0 | 33 | 5.5 | 108 | 118 | 26 | 79 | 18.0 | 32 | 5.3 | 103 | 117 |
| 6000 | -16 | 4 | 18.0 | 36 | 6.0 | 113 | 121 | 5 | 40 | 18.0 | 35 | 5.8 | 109 | 121 | 25 | 76 | 18.0 | 33 | 5.5 | 105 | 120 |
| 7000 | -17 | 1 | 18.0 | 37 | 6.2 | 115 | 125 | 3 | 37 | 18.0 | 36 | 6.0 | 110 | 124 | 23 | 73 | 18.0 | 34 | 5.7 | 106 | 124 |
| 8000 | -19 | -3 | 18.0 | 38 | 6.3 | 116 | 128 | 1 | 33 | 18.0 | 37 | 6.2 | 111 | 127 | 21 | 69 | 18.0 | 35 | 5.8 | 106 | 127 |
| 9000 | -21 | -6 | 18.0 | 39 | 6.5 | 117 | 131 | -1 | 30 | 18.0 | 38 | 6.3 | 112 | 130 | 19 | 66 | 18.0 | 36 | 6.0 | 108 | 130 |
| 10,000 | -23 | -10 | 18.0 | 40 | 6.7 | 117 | 134 | -3 | 26 | 18.0 | 39 | 6.5 | 113 | 134 | 17 | 62 | 18.0 | 37 | 6.2 | 108 | 133 |
| 11,000 | -25 | -13 | 18.0 | 41 | 6.8 | 117 | 136 | -5 | 23 | 18.0 | 39 | 6.5 | 113 | 136 | 15 | 59 | 18.0 | 38 | 6.3 | 108 | 135 |
| 12,000 | -27 | -17 | 18.0 | 41 | 6.8 | 117 | 138 | -7 | 19 | 18.0 | 40 | 6.7 | 113 | 138 | 13 | 55 | 18.0 | 38 | 6.3 | 108 | 137 |
| 13,000 | -29 | -20 | 18.0 | 42 | 7.0 | 117 | 140 | -9 | 16 | 18.0 | 41 | 6.8 | 113 | 140 | 11 | 52 | 18.0 | 39 | 6.6 | 108 | 139 |
| 14,000 | -31 | -24 | 17.3 | 43 | 7.2 | 117 | 142 | -11 | 12 | 17.3 | 41 | 6.8 | 112 | 142 | 9 | 48 | 17.3 | 40 | 6.7 | 108 | 141 |
| 15,000 | -33 | -27 | 16.5 | 41 | 6.8 | 114 | 140 | -13 | 9 | 16.5 | 40 | 6.7 | 109 | 140 | 7 | 45 | 16.5 | 38 | 6.3 | 105 | 138 |
| 16,000 | -35 | -31 | 15.8 | 39 | 6.5 | 110 | 138 | -15 | 5 | 15.8 | 38 | 6.3 | 106 | 137 | 5 | 41 | 15.8 | 37 | 6.2 | 101 | 136 |

- NOTES: 1. Full throttle manifold pressure settings are approximate.
 2. Shaded area represents operation with full throttle.
 3. Lean to 25° - 50°F on rich side of peak EGT.
 4. Cruise speeds are presented at an average weight of 3600 lbs.

5-40

January 1982

Section V
Performance

BEECHCRAFT
Duchess 76

INTENTIONALLY LEFT BLANK

RANGE PROFILE - 100 GALLONS STANDARD DAY (ISA)

ASSOCIATED CONDITIONS:

WEIGHT 3916 LBS BEFORE ENGINE START
 FUEL AVIATION GASOLINE
 FUEL DENSITY 6.0 LBS/GAL
 INITIAL FUEL LOADING 100 US GAL (600 LBS)
 COWL FLAPS CLOSED
 MIXTURE LEANED TO 25°-50°F ON RICH
 SIDE OF PEAK EGT

EXAMPLE:

PRESSURE ALTITUDE 11,500 FT
 POWER SETTING FT/2500 RPM
 RANGE 737 NM

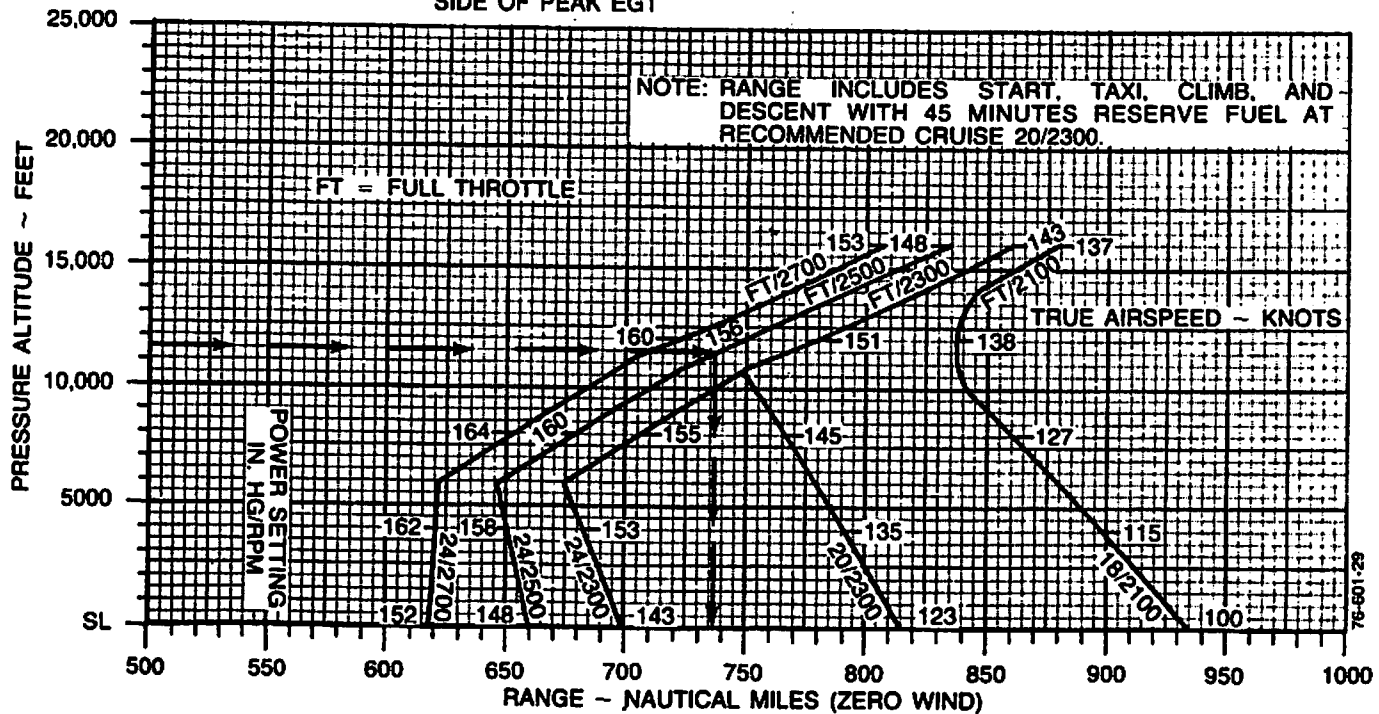

HOLDING TIME

APPLICABLE FOR ALL TEMPERATURES

ASSOCIATED CONDITIONS:

POWER SETTING 20 IN. HG OR FULL THROTTLE
 2300 RPM
 MIXTURE FULL RICH (ABOVE 5000 FT LEAN
 TO 75° - 100°F ON RICH SIDE
 OF PEAK EGT)

EXAMPLE:

FUEL AVAILABLE
 FOR HOLDING 50 GALLONS
 PRESSURE ALTITUDE 6000 FEET
 HOLDING TIME 3.3 HOURS

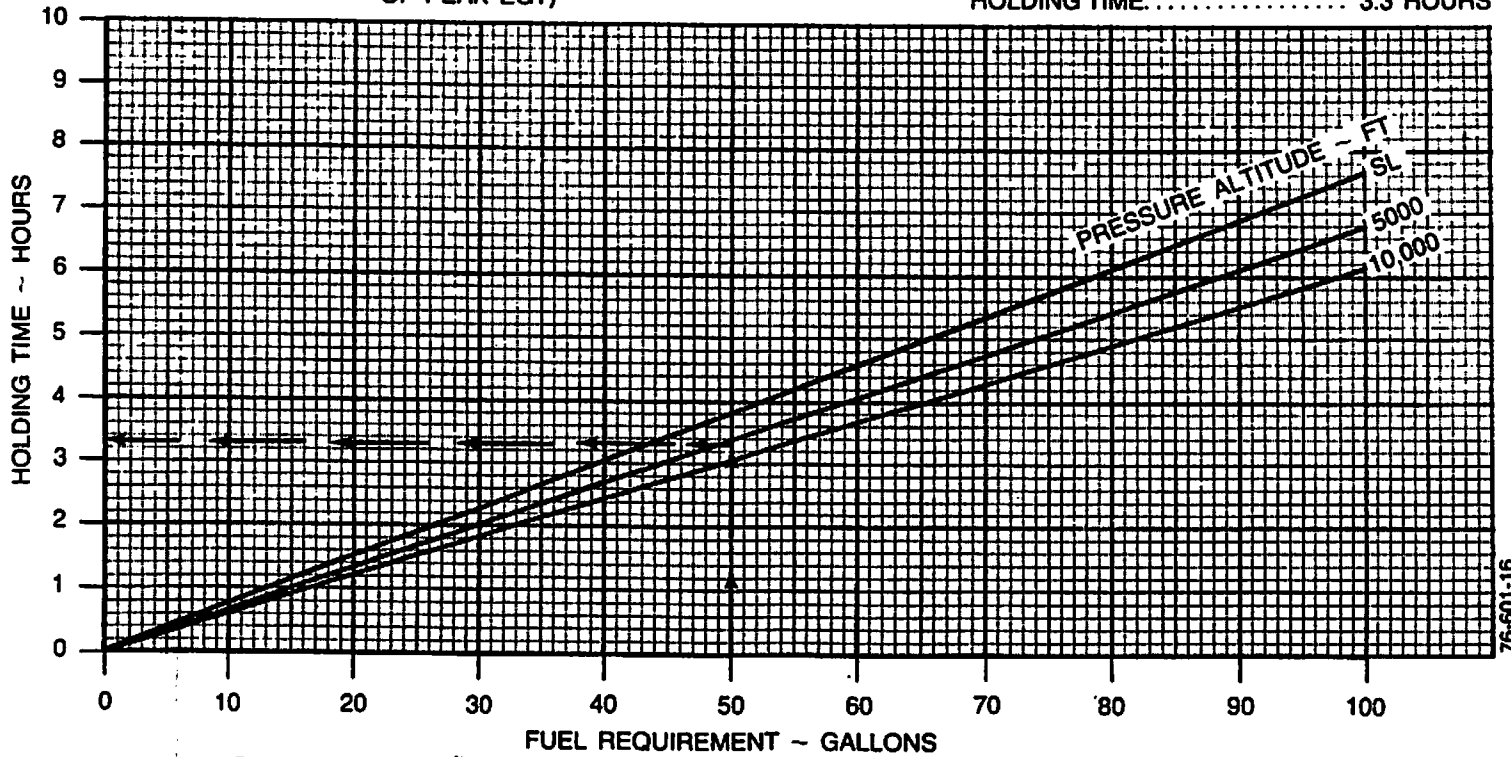

91-109-92

TIME, FUEL, AND DISTANCE TO DESCEND

DESCENT SPEED - 170 KNOTS

ASSOCIATED CONDITIONS:

POWER AS REQUIRED TO MAINTAIN
1000 FT/MIN RATE OF DESCENT
LANDING GEAR UP
FLAPS UP
MIXTURE FULL RICH (ABOVE 5000 FT LEAN TO
75° - 100°F ON RICH SIDE OF PEAK EGT)

EXAMPLE:

INITIAL ALTITUDE 11,500 FT
FINAL ALTITUDE 3965 FT
TIME TO DESCEND 10 - 4 = 6 MINUTES
FUEL TO DESCEND 3.4 - 1.3 = 2.1 GAL
DISTANCE TO DESCEND 32 - 11 = 21NM

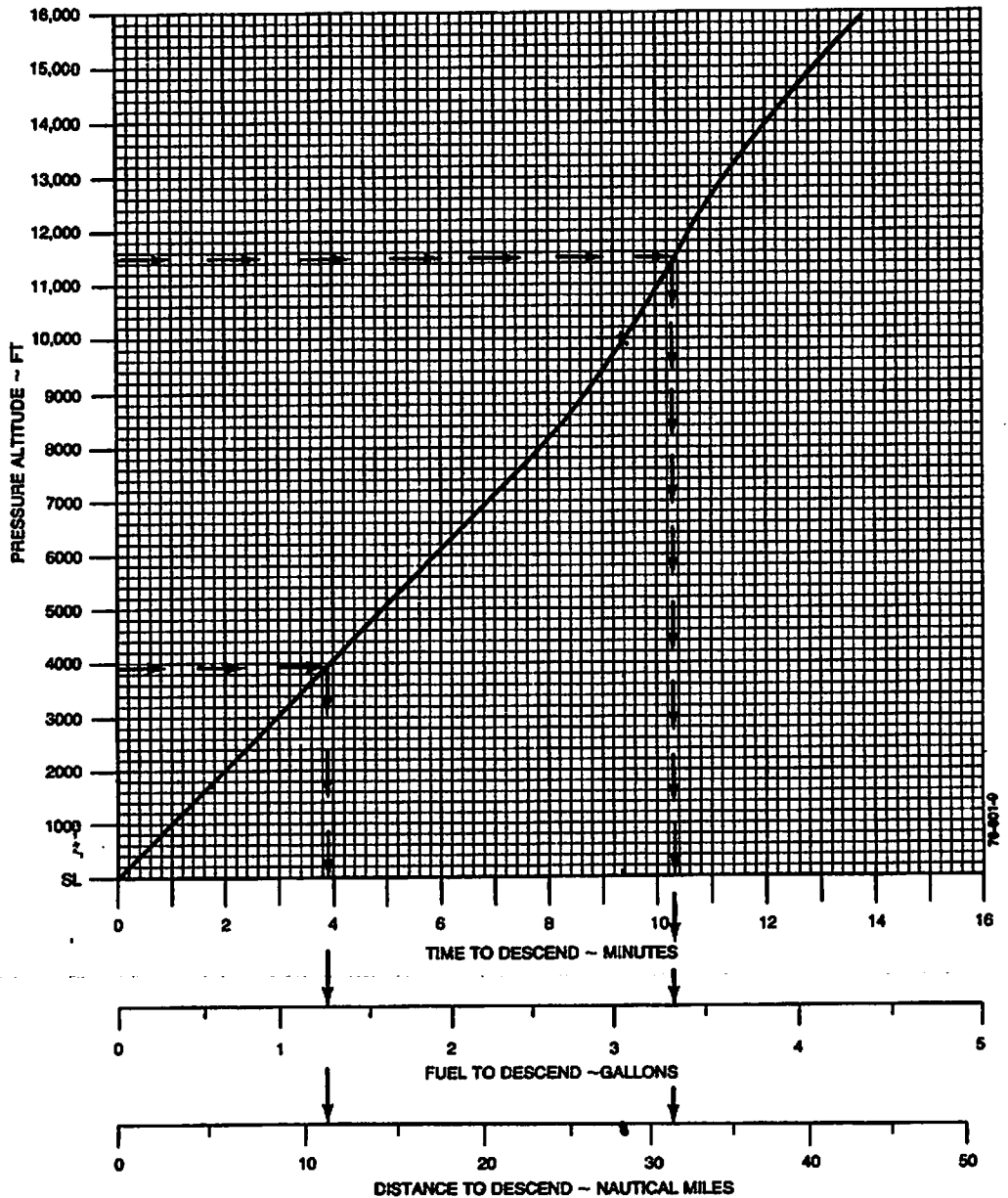

ASSOCIATED CONDITIONS:

POWER.....TAKE-OFF AT 2700 RPM
 FLAPS.....DOWN (DN)
 LANDING GEAR.....DOWN
 MIXTURE.....FULL RICH (ABOVE 5000 FT
 LEAN TO 75° - 100°F ON RICH
 SIDE OF PEAK EGT)

CLIMB - BALKED LANDING
CLIMB SPEED 71 KNOTS (ALL WEIGHTS)

EXAMPLE:

OAT.....25°C
 PRESSURE ALTITUDE.....3965 FT
 WEIGHT.....3677 LBS
 RATE OF CLIMB.....610 FT/MIN
 CLIMB GRADIENT.....8%

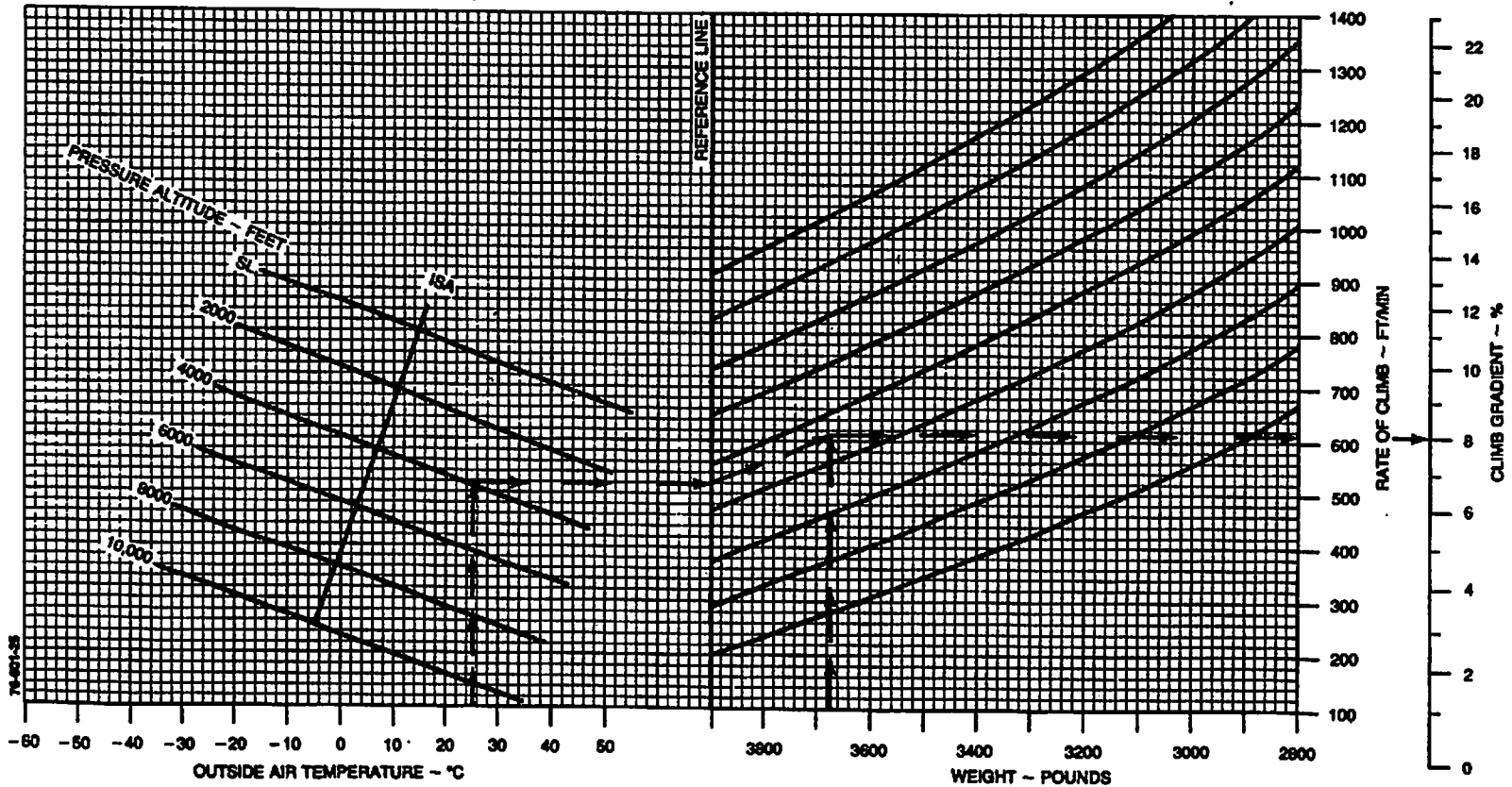

LANDING DISTANCE - FLAPS DOWN (DN)

APPROACH SPEED 76 KNOTS (ALL WEIGHTS)

ASSOCIATED CONDITIONS:

POWER..... RETARD TO MAINTAIN 600 FT/MIN
ON FINAL APPROACH
FLAPS..... DOWN (DN)
LANDING GEAR..... DOWN
RUNWAY..... PAVED, LEVEL, DRY SURFACE
APPROACH SPEED... 76 KNOTS IAS
BRAKING..... MAXIMUM

EXAMPLE:

OAT..... 25°C
PRESSURE ALTITUDE..... 3965 FT
HEADWIND COMPONENT..... 9.5 KTS
GROUND ROLL..... 1050 FT
TOTAL OVER 50 FT OBSTACLE..... 1970 FT
APPROACH SPEED..... 76 KTS

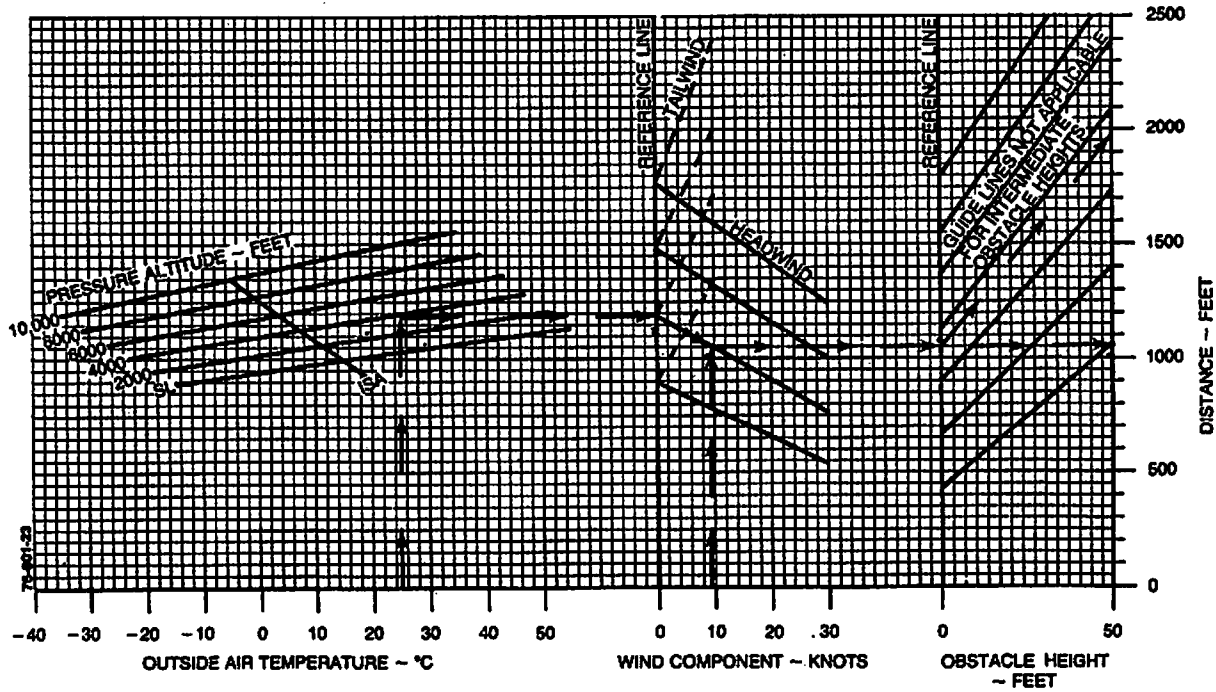

LANDING DISTANCE - FLAPS UP

APPROACH SPEED 87 KNOTS (ALL WEIGHTS)

ASSOCIATED CONDITIONS:

POWER..... RETARD TO MAINTAIN
600 FT/MIN ON FINAL
APPROACH
FLAPS..... UP
LANDING GEAR..... DOWN
RUNWAY..... PAVED, LEVEL,
DRY SURFACE
APPROACH SPEED 87 KNOTS IAS
BRAKING..... MAXIMUM

EXAMPLE:

FLAPS DN LANDING
DISTANCE OVER
50 FT OBSTACLE 1970 FT
FLAPS UP LANDING
DISTANCE OVER
50 FT OBSTACLE..... 2700 FT
APPROACH SPEED 87 KTS

NOTE: 1. LANDING WITH FLAPS FULL DOWN IS NORMAL PROCEDURE. USE THIS GRAPH WHEN IT IS NECESSARY TO LAND WITH FLAPS UP.

2. TO DETERMINE FLAPS UP LANDING DISTANCE, READ FROM THE LANDING DISTANCE - FLAPS DOWN GRAPH, THE LANDING DISTANCE APPROPRIATE TO OAT, ALTITUDE, WIND, AND 50 FT OBSTACLE. ENTER THIS GRAPH WITH DERIVED VALUE AND READ FLAPS UP LANDING DISTANCE.

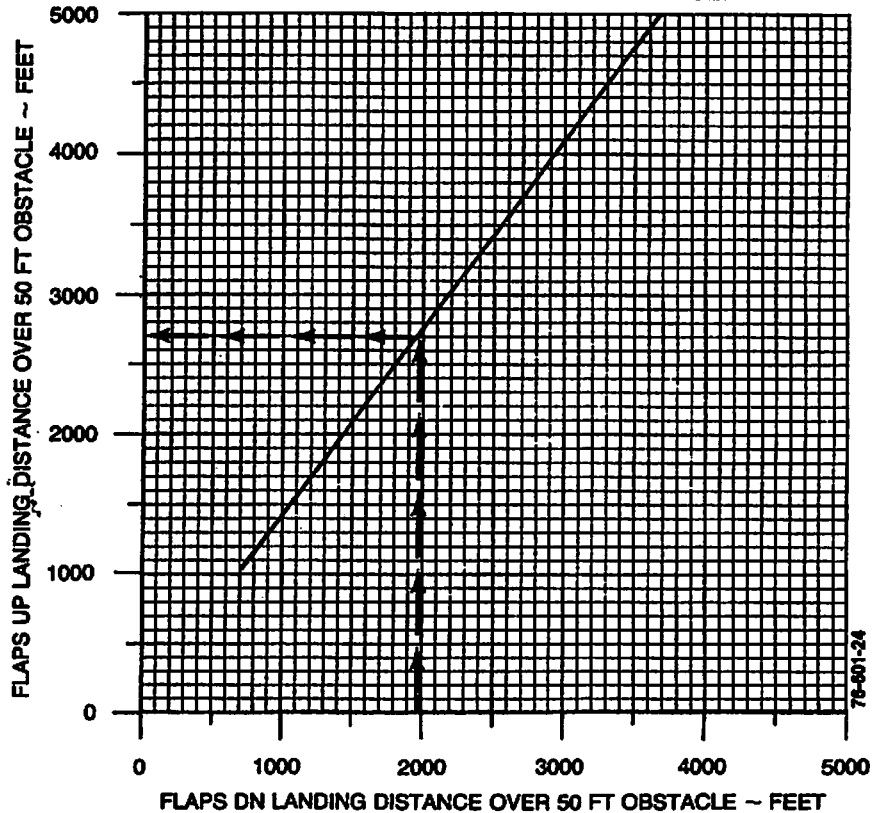

LANDING DISTANCE - GRASS SURFACE - FLAPS DOWN (DN)

APPROACH SPEED 76 KTS (ALL WEIGHTS)

ASSOCIATED CONDITIONS:

POWER RETARD TO MAINTAIN 600 FT/MIN
 ON FINAL APPROACH
 FLAPS DOWN (DN)
 LANDING GEAR .. DOWN
 RUNWAY SHORT, DRY, GRASS
 APPROACH
 SPEED 76 KTS
 BRAKING MAXIMUM

EXAMPLE:

OAT 25°C
 PRESSURE ALTITUDE 3985 FT
 HEADWIND COMPONENT 9.5 KTS
 GROUND ROLL 1250 FT
 TOTAL OVER 50 FT OBSTACLE 2150 FT
 APPROACH SPEED 76 KTS

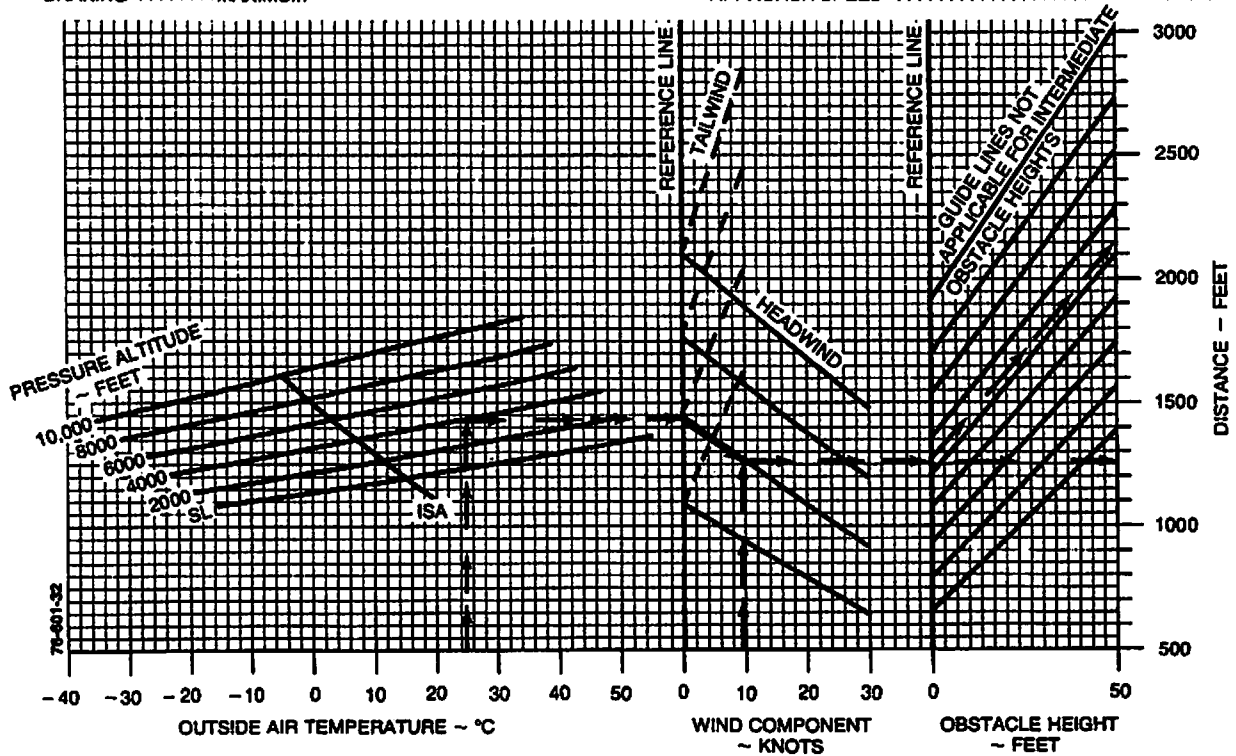

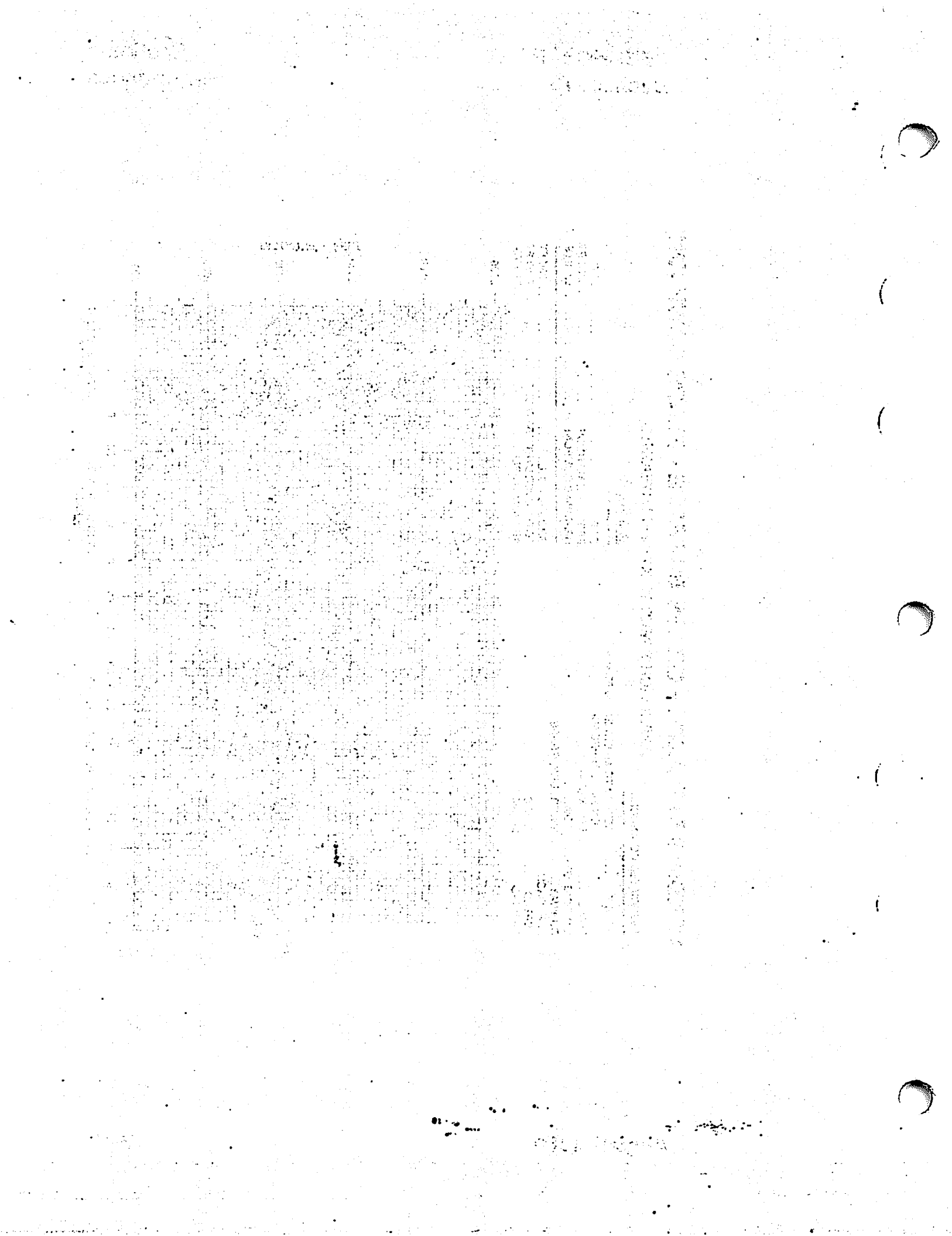

WT & BAL/EQUIP LIST

INTENTIONALLY LEFT BLANK

AIRPLANE WEIGHING PROCEDURE

Periodic weighing of the airplane may be required to keep the basic empty weight current. Frequency of weighing is to be determined by the operator. All changes to the airplane affecting weight and/or balance are the responsibility of the airplane operator.

1. The airplane may be weighed on wheels or on weighing points. Two weighing points are provided on the wing main spar at F.S. 129.37, and one on the lower aft fuselage tail skid aft attach point at F.S. 278.61.

2. Fuel is normally drained preparatory to a weighing from the regular drain ports while the airplane is in static ground attitude. When tanks are drained, 1.6 pounds of undrainable fuel remain in the airplane at F.S. 124.8. The remainder of the unusable fuel to be added to a drained system is 18.0 pounds at F.S. 123.0. If the airplane is weighed with fuel tanks topped off full, the fuel specific weight (pounds/gallon) should be determined by using a hydrometer. Compute total fuel weight by multiplying measured specific weight by 100 gallons. Fuel moment is determined by interpolation from fuel table.

3. Engine oil is to be at the full level as indicated by the dipstick. Total engine oil aboard when engines and systems are full is 37 pounds at F.S. 75.4

4. To determine airplane configuration at time of weighing, installed equipment is checked against the airplane equipment list or superseding forms. All equipment must be in its proper place during weighing.

5. The airplane weighing is performed with landing gear down, control surfaces in neutral position and doors closed.

Section VI
Wt & Bal/Equip List

BEECHCRAFT
Duchess 76

6. The airplane is placed on the scales in level attitude. Leveling is accomplished with a spirit level on the aft baggage compartment floor. Leveling while on weighing points may require the nose gear shock strut to be secured in the static position to prevent its extension. Wheel weighings can be leveled by deflating the nose gear shock strut and/or tire.

7. Measurement of the reaction arms for a wheel weighing is made using the wing jack point at F.S. 129.37 for a jig point. While the airplane is level on the scales, linear measurements are taken from the reference (a plumb bob hanging from the center of either wing jack point) to the axle centerline of the main gear and then from the main wheel axle centerline to the nose gear axle centerline. The main wheel axle centerline is best located by stretching a string from one wheel to the other. All measurements are to be taken with the tape level with the floor and parallel to fuselage water lines. The location of the wheel reactions will be approximately at F.S. 132 for the main wheels and F.S. 47 for the nose wheel.

8. The wing and fuselage weighing points are used by placing scales on the points as specified in Step 1. Since the center of gravity of the airplane will be forward of the weighing points at F.S. 129.37, the tail reaction of the rear weighing point at F.S. 278.61 will be in an up direction. This can be measured on regular scales by placing ballast of approximately 400 pounds on the scale to which the rear weighing point adapter is attached by cable or adjustable chain (may be used for leveling). The up reaction will be the total ballast weight minus the scale reading and is entered in the weighing form as a negative quantity.

9. The basic empty weight and moment are determined on the basic empty weight and balance form. Items weighed

which are not part of the basic empty weight are subtracted, i.e. usable fuel. Engine oil and unusable fuel are added if not already in the airplane.

10. Weighing should be made in an enclosed area which is free from air currents. The scales used should be properly calibrated and certified.

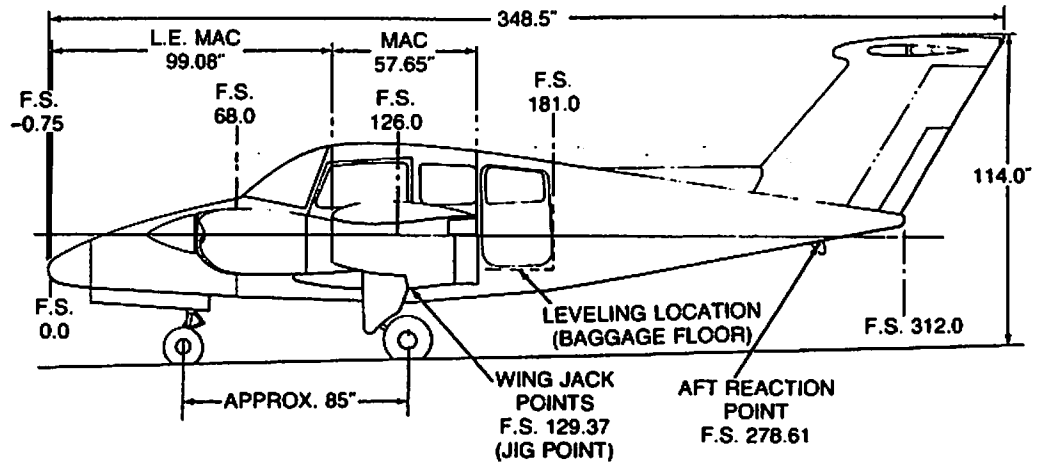

76-603-6

**Section VI
Wt & Bal/Equip List**

**BEECHCRAFT
Duchess 76 :**

INTENTIONALLY LEFT BLANK

January 1978

AIRCRAFT BASIC EMPTY WEIGHT AND BALANCE

DUCHESS 76
STRUT POSITION
 EXTENDED
 COMPRESSED

SER. NO. _____ REG. NO. _____ DATE _____
NOSE MAIN JACK POINT LOCATION
 46.4 126.8 FORWARD 129.37
 47.9 133.5 AFT 278.61

PREPARED BY
 Company _____
 Signature _____

| REACTION WHEEL - JACK POINTS | SCALE READING | TARE | NET WEIGHT | ARM | MOMENT |
|---------------------------------|------------------|------|------------|-----|--------|
| LEFT MAIN | | | | | |
| RIGHT MAIN | | | | | |
| NOSE OR TAIL | | | | | |
| TOTAL (AS WEIGHED) | | | | | |

Space below provided for additions and subtractions to as weighed condition.

| | | | | | |
|--------------------|--|--|----|-------|------|
| EMPTY WEIGHT | | | | | |
| ENGINE OIL | | | 37 | 75.4 | 2790 |
| UNUSABLE FUEL | | | 20 | 123.2 | 2464 |
| BASIC EMPTY WEIGHT | | | | | |

6-7

BEECHCRAFT
 Duchess 76

Section VI
 Wt & Bal/Equip List

NOTE

Each new airplane is delivered with a completed sample loading, basic empty weight and center of gravity, and equipment list, all pertinent to that specific airplane. It is the owner's responsibility to ensure that changes in equipment are reflected in a new weight and balance and in an addendum to the equipment list. There are many ways of doing this; it is suggested that a running tally of equipment changes and their effect on basic empty weight and c.g. is a suitable means for meeting both requirements.

The current equipment list and basic empty weight and c.g. information must be retained with the airplane when it changes ownership. Beech Aircraft Corporation cannot maintain this information; the current status is known only to the owner. If these papers become lost, the FAA will require that the airplane be re-weighed to establish the basic empty weight and c.g. and that an inventory of installed equipment be conducted to create a new equipment list.

It is recommended that duplicate copies of the Basic Empty Weight and Balance sheet and the Equipment List be made and kept in an alternate location in the event the original handbook is misplaced.

LOADING INSTRUCTIONS

It is the responsibility of the airplane operator to assure that the airplane is properly loaded. At the time of delivery, Beech Aircraft Corporation provides the necessary weight and balance data to compute individual loadings. All subsequent changes in airplane weight and balance are the responsibility of the airplane owner and/or operator.

**BEECHCRAFT
Duchess 76**

**Section VI
Wt & Bal/Equip List**

The basic empty weight and moment of the airplane at the time of delivery are shown on the airplane Basic Empty Weight and Balance form. Useful load items which may be loaded into the airplane are shown on the Useful Load Weight and Moment tables. The minimum and maximum moments are shown on the Moment Limits vs Weight graph or table. These moments correspond to the forward and aft center of gravity flight limits for a particular weight. All moments are divided by 100 to simplify computations.

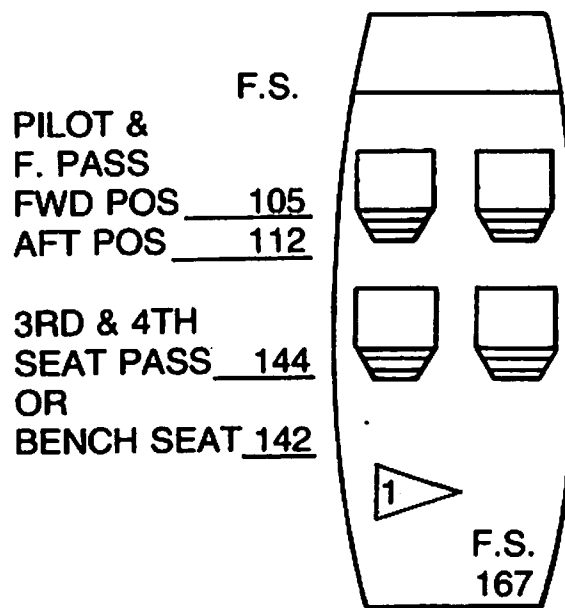

NOTE

THE FLOOR STRUCTURE LOAD LIMIT IS
100 POUNDS PER SQUARE FOOT.

ALL BAGGAGE/CARGO MUST BE SECURED.

 MAXIMUM WEIGHT 200 POUNDS INCLUDING
EQUIPMENT AND BAGGAGE

76-603-8

MOMENT LIMITS VS WEIGHT

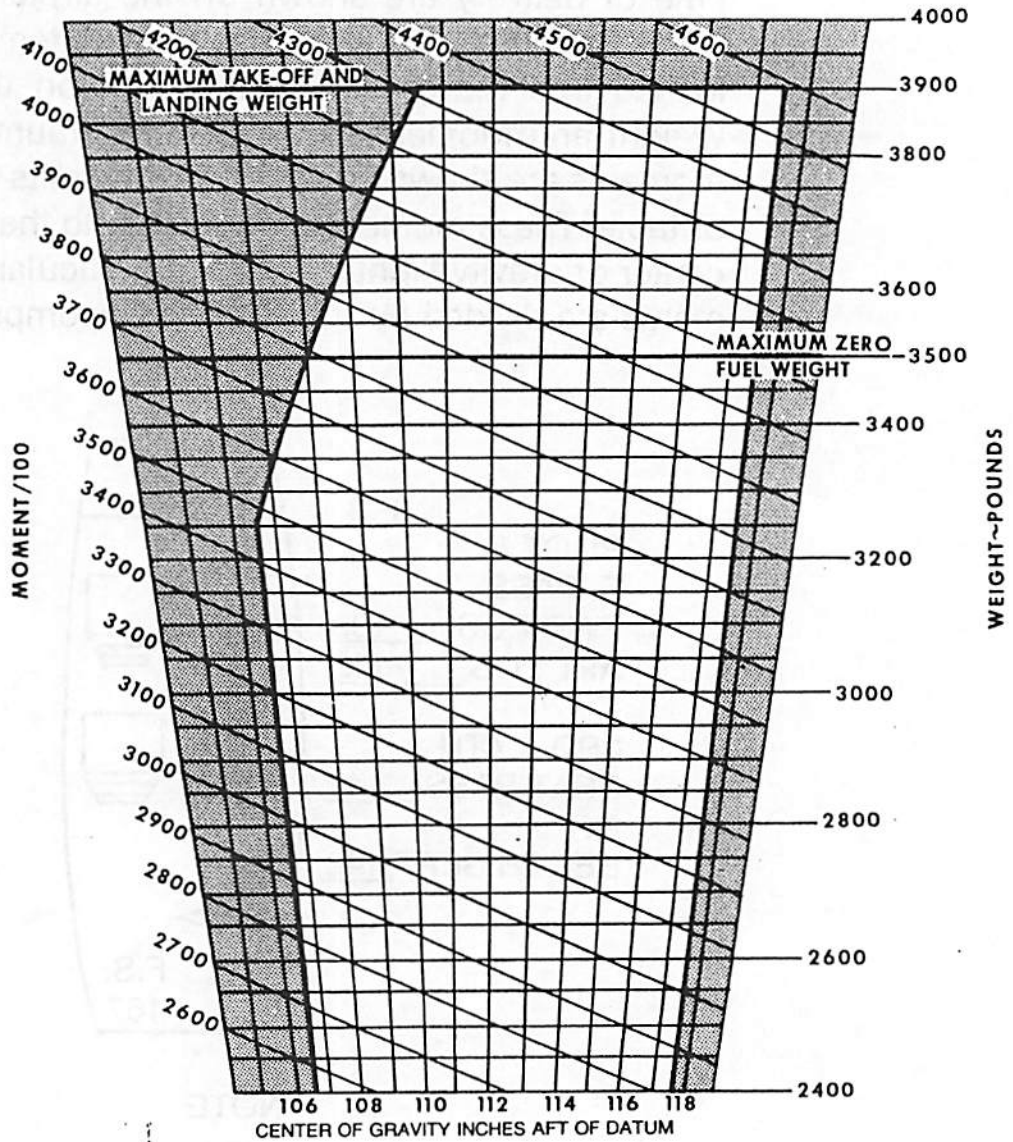

ENVELOPE BASED ON THE FOLLOWING WEIGHT AND CENTER OF GRAVITY LIMIT DATA (LANDING GEAR DOWN)

| WEIGHT CONDITION | FWD C. G. LIMIT | AFT C. G. LIMIT |
|-------------------------------------|-----------------|-----------------|
| 3900 POUNDS (MAX. TAKE-OFF/LANDING) | 110.6 | 117.5 |
| 3250 POUNDS OR LESS | 106.6 | 117.5 |

76-601-6

MOMENT LIMITS vs WEIGHT

| WEIGHT POUNDS | MOMENT/100 | | WEIGHT POUNDS | MOMENT/100 | |
|------------------|--------------|--------------|------------------|--------------|--------------|
| | FWD LIMIT | AFT LIMIT | | FWD LIMIT | AFT LIMIT |
| 2300 | 2452 | 2703 | 3125 | 3331 | 3672 |
| 2325 | 2479 | 2732 | 3150 | 3358 | 3701 |
| 2350 | 2505 | 2761 | 3175 | 3385 | 3731 |
| 2375 | 2532 | 2791 | 3200 | 3411 | 3760 |
| 2400 | 2558 | 2820 | | | |
| 2425 | 2585 | 2849 | 3225 | 3438 | 3789 |
| 2450 | 2612 | 2879 | 3250 | 3465 | 3819 |
| 2475 | 2638 | 2908 | 3275 | 3496 | 3848 |
| 2500 | 2665 | 2938 | 3300 | 3528 | 3878 |
| 2525 | 2692 | 2967 | 3325 | 3560 | 3907 |
| 2550 | 2718 | 2996 | 3350 | 3592 | 3936 |
| 2575 | 2745 | 3026 | 3375 | 3624 | 3966 |
| 2600 | 2772 | 3055 | 3400 | 3656 | 3995 |
| 2625 | 2798 | 3084 | 3425 | 3688 | 4024 |
| 2650 | 2825 | 3114 | 3450 | 3720 | 4054 |
| 2675 | 2852 | 3143 | 3475 | 3753 | 4083 |
| 2700 | 2878 | 3173 | 3500 | 3785 | 4113 |
| 2725 | 2905 | 3202 | 3525 | 3817 | 4142 |
| 2750 | 2932 | 3231 | 3550 | 3850 | 4171 |
| 2775 | 2958 | 3261 | 3575 | 3882 | 4201 |
| 2800 | 2985 | 3290 | 3600 | 3915 | 4230 |
| 2825 | 3012 | 3319 | 3625 | 3948 | 4259 |
| 2850 | 3038 | 3349 | 3650 | 3981 | 4289 |
| 2875 | 3065 | 3378 | 3675 | 4014 | 4318 |
| 2900 | 3091 | 3408 | 3700 | 4047 | 4348 |
| 2925 | 3118 | 3437 | 3725 | 4080 | 4377 |
| 2950 | 3145 | 3466 | 3750 | 4113 | 4406 |
| 2975 | 3171 | 3496 | 3775 | 4146 | 4436 |
| 3000 | 3198 | 3525 | 3800 | 4179 | 4465 |
| 3025 | 3225 | 3554 | 3825 | 4213 | 4494 |
| 3050 | 3251 | 3584 | 3850 | 4246 | 4524 |
| 3075 | 3278 | 3613 | 3875 | 4280 | 4553 |
| 3100 | 3305 | 3643 | 3900 | 4313 | 4583 |

COMPUTING PROCEDURE

1. Record the Basic Empty Weight and Moment from the Basic Empty Weight and Balance form (or from the latest superseding form) under the Basic Empty Condition block. The moment must be divided by 100 to correspond to Useful Load Weights and Moments tables.

2. Record the weight and corresponding moment from the appropriate table of each of the useful load items (except fuel) to be carried in the airplane.

3. Total the weight column and moment column. The SUB-TOTALS are the ZERO FUEL CONDITION.

4. Determine the weight and corresponding moment for the total fuel loading to be used. Add the Total Fuel Loading Condition to Zero Fuel Condition to obtain the SUB-TOTAL Ramp Condition.

5. Subtract the fuel to be used for start and taxi to arrive at the SUB-TOTAL Take-off Condition.

6. Subtract the weight and moment of the FUEL TO DESTINATION from the take-off weight and moment. (Determine the weight and moment of this fuel by subtracting the amount on board at landing from the amount on board at takeoff;) The Zero Fuel Condition, the Take-off Condition and the Landing Condition moment must all be within the minimum and maximum moments shown on the Moment Limits vs Weight graph or table for that weight. If the total moment is less than the minimum moment allowed, useful load items must be shifted aft or forward load items reduced. If the total moment is greater than the maximum moment allowed, useful load items must be shifted forward or aft load items reduced. If the quantity or location of load items is changed, the calculations must be revised and the moments rechecked.

**BEECHCRAFT
Duchess 76**

**Section VI
Wt & Bal/Equip List**

The following Sample Loading chart is presented to depict the sample method of computing a load. Weights used DO NOT reflect an actual airplane loading.

WEIGHT AND BALANCE LOADING FORM

MODEL DUCHESS 76
SERIAL NO. ME-00

DATE 0/0/00
REG. NO. NXXXXX

| ITEM | WEIGHT | MOM/100 |
|--|--------|---------|
| 1. BASIC EMPTY CONDITION | 2543 | 2775 |
| 2. FRONT SEAT OCCUPANTS | 340 | 380 |
| 3. 3rd & 4th SEAT OCCUPANTS OR BENCH SEAT OCCUPANTS | 340 | 490 |
| 4. | - | - |
| 5. AFT BAGGAGE | 93 | 155 |
| 6. SUB TOTAL ZERO FUEL CONDITION (3500 LBS MAX.) | 3316 | 3800 |
| 7. FUEL LOADING (100 gal.) | 600 | 702 |
| 8. SUB TOTAL RAMP CONDITION | 3916 | 4502 |
| 9. *LESS FUEL FOR START, TAXI, AND TAKEOFF | -16 | -19 |
| 10. SUB TOTAL TAKE-OFF CONDITION | 3900 | 4483 |
| 11. LESS FUEL TO DESTINATION (80 gal.) | -480 | -562 |
| 12. LANDING CONDITION | 3420 | 3921 |

*Fuel for start, taxi, and takeoff is normally 16 lbs at an average mom/100 of 19.

WEIGHT AND BALANCE LOADING FORM

MODEL DUCHESS 76

DATE _____

SERIAL NO. _____

REG. NO. _____

| ITEM | WEIGHT | MOM/100 |
|---|--------|---------|
| 1. BASIC EMPTY CONDITION | | |
| 2. FRONT SEAT OCCUPANTS | | |
| 3. 3rd & 4th SEAT OCCUPANTS OR BENCH SEAT OCCUPANTS | | |
| 4. | | |
| 5. AFT BAGGAGE | | |
| 6. SUB TOTAL ZERO FUEL CONDITION (3500 LBS MAX.) | | |
| 7. FUEL LOADING (gal.) | | |
| 8. SUB TOTAL RAMP CONDITION | | |
| 9. *LESS FUEL FOR START, TAXI, AND TAKEOFF | | |
| 10. SUB TOTAL TAKE-OFF CONDITION | | |
| 11. LESS FUEL TO DESTINATION | | |
| 12. LANDING CONDITION | | |

*Fuel for start, taxi, and takeoff is normally 16 lbs at an average mom/100 of 19.

USEFUL LOAD WEIGHTS AND MOMENTS

| WEIGHT | OCCUPANTS | | | | | |
|------------|----------------------------|---------------------------|----------------------------|--------------|----------|--|
| | FRONT SEATS | | 3RD AND 4TH SEATS | | OPTIONAL | |
| | *FWD POS. †ARM **104 | *AFT POS. ARM **112 | STD. BENCH ARM **142 | ARM **144 | | |
| MOMENT/100 | | | | | | |
| 120 | 125 | 126 | 134 | 170 | 173 | |
| 130 | 135 | 137 | 146 | 185 | 187 | |
| 140 | 146 | 147 | 157 | 199 | 202 | |
| 150 | 156 | 158 | 168 | 213 | 216 | |
| 160 | 166 | 168 | 179 | 227 | 230 | |
| 170 | 177 | 179 | 190 | 241 | 245 | |
| 180 | 187 | 189 | 202 | 256 | 259 | |
| 190 | 198 | 200 | 213 | 270 | 274 | |
| 200 | 208 | 210 | 224 | 284 | 288 | |
| 210 | 218 | 220 | 235 | 298 | 302 | |
| 220 | 228 | 231 | 246 | 312 | 317 | |
| 230 | 239 | 241 | 258 | 327 | 331 | |
| 240 | 250 | 252 | 269 | 341 | 346 | |
| 250 | 260 | 262 | 280 | 355 | 360 | |

† Effective ME-1 thru ME-20

†† Effective ME-21 and after

* Reclining seat with back in full-up position

** Values computed from a C.G. criterion based on a 170 pound male. Differences in physical characteristics can cause variation in center of gravity location.

USEFUL LOAD WEIGHTS AND MOMENTS

BAGGAGE
ARM 167

| WEIGHT | <u>MOMENT</u> 100 |
|---------------|------------------------------------|
| 10 | 17 |
| 20 | 33 |
| 30 | 50 |
| 40 | 67 |
| 50 | 84 |
| 60 | 100 |
| 70 | 117 |
| 80 | 134 |
| 90 | 150 |
| 100 | 167 |
| 110 | 184 |
| 120 | 200 |
| 130 | 217 |
| 140 | 234 |
| 150 | 251 |
| 160 | 267 |
| 170 | 284 |
| 180 | 301 |
| 190 | 317 |
| 200 | 334 |

**USEFUL LOAD WEIGHTS AND MOMENTS
USABLE FUEL
ARM 117.0**

| GALLONS | WEIGHT LBS | <u>MOMENT</u> 100 |
|----------------|-----------------------|------------------------------|
| 10 | 60 | 70 |
| 20 | 120 | 140 |
| 30 | 180 | 211 |
| 40 | 240 | 281 |
| 50 | 300 | 351 |
| 60 | 360 | 421 |
| 70 | 420 | 491 |
| 80 | 480 | 562 |
| 90 | 540 | 632 |
| 100 | 600 | 702 |

SYSTEMS DESCRIPTION

SECTION VII

SYSTEMS DESCRIPTION

TABLE OF CONTENTS

| <i>SUBJECT</i> | <i>PAGE</i> |
|----------------------------------|-------------|
| Airframe | 7-5 |
| Seating Arrangements | 7-5 |
| Flight Controls..... | 7-5 |
| Control Surfaces | 7-5 |
| Control Column | 7-5 |
| Rudder Pedals | 7-6 |
| Trim Controls..... | 7-6 |
| Manual Elevator Trim..... | 7-6 |
| Electric Elevator Trim..... | 7-6 |
| Aileron Trim | 7-7 |
| Instrument Panel..... | 7-7 |
| Illustration..... | 7-8 |
| Flight Instruments..... | 7-9 |
| Engine Instrumentation | 7-9 |
| Ground Control | 7-9 |
| Wing Flaps..... | 7-10 |
| Landing Gear System | 7-10 |
| Control Switch | 7-10 |
| Position Indicators | 7-11 |
| Time-delay Relay | 7-11 |
| Safety Retraction Switch | 7-11 |
| Warning Horn..... | 7-12 |
| Warning Horn "Q" Switch | 7-12 |
| Warning Horn Silence Button..... | 7-12A |
| Circuit Breaker | 7-12A |
| Emergency Extension..... | 7-12A |
| Brakes | 7-13 |

TABLE OF CONTENTS (Continued)

| <i>SUBJECT</i> | <i>PAGE</i> |
|--|-------------|
| Baggage Compartment..... | 7-13 |
| Seats, Seat Belts, and Shoulder Harnesses | |
| Seats..... | 7-14 |
| Seat Belts..... | 7-14 |
| Shoulder Harnesses..... | 7-15 |
| Doors and Exits | |
| Forward Cabin Doors | 7-15 |
| Aft Utility Door | 7-16 |
| Emergency Exits | 7-16 |
| Control Lock..... | 7-16 |
| Engines..... | 7-17 |
| Engine Controls | 7-17 |
| Throttle, Propeller, and Mixture | 7-17 |
| Engine Instrumentation..... | 7-18 |
| Manifold Pressure Gage..... | 7-18 |
| Exhaust Gas Temperature Indicator (EGT)..... | 7-18 |
| Engine Break-in Information | 7-19 |
| Engine Lubrication..... | 7-19 |
| Engine Ice Protection..... | 7-19 |
| Carburetor Heat | 7-20 |
| Induction Air..... | 7-20 |
| Cowl Flaps..... | 7-20 |
| Starters..... | 7-20 |
| Propellers | 7-21 |
| Fuel System..... | 7-21 |
| Fuel Tanks | 7-22 |
| Fuel Selector Valves | 7-22 |
| Schematic | 7-23 |
| Fuel Drains..... | 7-24 |
| Fuel Quantity Indicators | 7-24 |
| Auxiliary Fuel Pumps..... | 7-24 |
| Engine Priming..... | 7-25 |
| Fuel Crossfeed..... | 7-25 |
| Fuel Required for Flight..... | 7-25 |

TABLE OF CONTENTS (Continued)

| <i>SUBJECT</i> | <i>PAGE</i> |
|-------------------------------------|-------------|
| Electrical System | 7-26 |
| Battery..... | 7-26 |
| Schematic | 7-27 |
| Alternators..... | 7-28 |
| Starters | 7-29 |
| Starter Engaged Warning Light | 7-30 |
| External Power..... | 7-30 |
| Lighting Systems | |
| Interior Lighting | 7-34 |
| Exterior Lighting | 7-34 |
| Environmental Systems | |
| Cabin Heating | 7-35 |
| Illustration..... | 7-36 |
| Heater Operation..... | 7-37 |
| Cabin Ventilation | 7-38 |
| Overhead Fresh Air Outlets..... | 7-38 |
| Exhaust Vent..... | 7-39 |
| Pitot and Static Systems | 7-39 |
| Pitot System | 7-39 |
| Pitot Heat..... | 7-39 |
| Static System | 7-40 |
| Pressure System | 7-40 |
| Stall Warning System..... | 7-41 |

INTENTIONALLY LEFT BLANK

AIRFRAME

The BEECHCRAFT Duchess 76 is an all-metal, low-wing, twin-engine airplane with retractable tricycle landing gear. The T-tail empennage assembly consists of a vertical stabilizer and a top-mounted horizontal stabilizer.

SEATING ARRANGEMENTS

In the standard configuration the airplane is equipped with two adjustable pilot seats and one rear fixed-bench seat. In the optional configuration, split third and fourth seats are installed to replace the fixed-bench seat. To adjust either of the front seats, pull the release knob located below the left forward seat corner (pull to the right, then up) and slide the seat forward or aft, to the desired position. Each seat should be locked securely in place, after adjustment. The backs of all individual seats can be placed in any of three positions by means of a lever located on the side of each seat. Headrests are available for each of the individual seats. Outboard armrests, for the front seats, are attached to the cabin doors.

FLIGHT CONTROLS

CONTROL SURFACES

The control surfaces are bearing supported and operated through conventional cable systems and push-pull rods terminating in bell cranks.

CONTROL COLUMN

The airplane is equipped with dual control columns for the pilot and copilot. The control wheels are interconnected and provide aileron and elevator control.

RUDDER PEDALS

The standard installation provides a set of rudder pedals for both the pilot and copilot. The main landing gear wheel brakes are operated by applying toe pressure to either set of rudder pedals.

TRIM CONTROLS

Trim tabs on the rudder and elevator are adjustable with the controls that are mounted on the lower center console. The trim tabs and controls are connected through closed cable systems. Mechanical position indicators for each of the trim tabs are integrated with their respective controls. Elevator trim is accomplished through either the electric or manual pitch trim system.

MANUAL ELEVATOR TRIM

The manual elevator trim is actuated by a handwheel located between the pilot seats. An elevator tab position indicator is located adjacent to the trim control handwheel. Forward rotation of wheel trims the airplane nose down, aft rotation trims nose up.

ELECTRIC ELEVATOR TRIM

The electric elevator trim system is controlled by the ON-OFF circuit-breaker-type switch located on the left subpanel and a thumb switch located on the pilot's control wheel. The ON-OFF switch must be in the ON position to operate the system. The thumb switch is depressed and moved forward for nose down, aft for nose up, and when released, returns to the center OFF position. When the system is not being electrically actuated, the manual trim control wheel may be used.

An emergency release button, incorporated in the system, is located on the left handle grip of the pilot's control wheel. This button can be quickly depressed to deactivate the system in case of a malfunction in the system. The system will remain deactivated only while the button is being held in the depressed position.

AILERON TRIM

The aileron trim control, located on the lower center console, is provided to displace the ailerons for trimming purposes. Displacement is maintained by cable loads imposed by the trimmer.

INSTRUMENT PANEL

The standard instrument panel consists of flight, navigation, and engine instruments on the left, and an avionics section on the right.

The lower left subpanel contains the switches for control of the battery and alternators, magneto/start and prime, lights, environmental, and optional equipment. Also contained on the left subpanel are the auxiliary fuel pump switches, instrument air gage, landing gear control switch and gear indicator lights.

Located on the lower right subpanel are the rheostat switches for the instrument flood and post lights, parking brake control knob, flap switch, and flap position indicator. All of the circuit breakers, that are associated with the various placarded systems, are also located on the lower right subpanel.

FLIGHT INSTRUMENTS

The flight instruments are located on the instrument panel directly in front of the pilot's seat. Available flight instrumentation includes attitude and directional gyros, airspeed, altimeter, turn coordinator, vertical speed, and gyro pressure. The magnetic compass is mounted above the instrument panel and the outside air temperature indicator is located in the lower left corner of the windshield (ME-1 through ME-440) or in the center of the windshield above the compass (ME-441 and after). The clock is mounted in the upper left portion of the instrument panel.

ENGINE INSTRUMENTATION

Most of the engine instruments are located in the center of the instrument panel. This group includes left and right instruments for fuel quantity, fuel pressure, oil pressure, oil temperature, cylinder head temperature, and loadmeters. The alternator-out annunciator lights for each alternator and the test switch are located adjacent to the loadmeters. The balance of the engine instruments, located above the left subpanel, include a dual indicating manifold pressure gage, tachometers, and a dual indicating exhaust gas temperature indicator. A dual indicating tachometer (ME-140 and after) is offered as optional equipment in lieu of the two (left and right) standard tachometer indicators.

GROUND CONTROL

The spring-loaded linkage from the nose gear to the rudder pedals allows for nose wheel steering. Smooth turning is accomplished by allowing the airplane to roll while depressing the appropriate rudder pedal. Sharper turns require light brake pedal pressure on the depressed rudder pedal.

The minimum wing-tip turning radius of 27 feet 2 inches is accomplished by using full steering, one brake, and differential power.

WING FLAPS

The wing flaps are controlled by a three-position switch, UP, OFF, and DOWN, located on the subpanel, to the right of the control console. The switch must be pulled out of detent before it can be repositioned. A dial-type indicator, located adjacent to the flap switch, has position markings for UP, 10°, 20°, and DN.

Limit switches automatically interrupt power to the electric motor when the flaps reach the extremes of travel. Intermediate flap positions can be obtained by placing the three-position switch in the OFF position during flap extension or retraction.

Lowering the flaps in flight will produce the following effects:

Attitude - Nose Down
Airspeed - Reduced
Stall Speed - Lowered

When the flaps are extended beyond approximately 16°, the landing gear warning horn will sound (regardless of throttle position) if the landing gear is not down and locked.

LANDING GEAR SYSTEM

The retractable tricycle landing gear is fabricated from magnesium castings and aluminum forgings. Retraction and extension of the gear is accomplished through the use of an electrically driven hydraulic pump and hydraulic system terminating in a hydraulic actuator assembly mounted in each wheel well. The landing gear may be hydraulically extended or retracted, and may be lowered manually.

CONTROL SWITCH

The landing gear is controlled by a two-position switch located on the left subpanel. The switch handle must be pulled out of the safety detent before it can be moved to the opposite position.

POSITION INDICATORS

The landing gear position indicator lights are located above the landing gear switch handle. Three green lights, one for each gear, are illuminated whenever the landing gear is down and locked. The red light illuminates any time the landing gear is in transit or in any intermediate position. All of the lights will be extinguished when the gear is up.

Pressing the face of each landing gear position indicator light will verify the landing gear lights are functional. The intensity of the lamps can be controlled by turning the lens holder on each lamp.

TIME-DELAY RELAY (ME-183 and after)

Landing gear retraction operation is protected by a time-delay relay which will disengage electrical power to the hydraulic pump motor after 30 seconds of continuous pump operation. If the landing gear in-transit light remains illuminated, it indicates improper response of the landing gear. The time-delay relay can be reset by moving the landing gear switch handle to the down position. The landing gear and retract system should be checked before the next flight.

SAFETY RETRACTION SWITCH

To prevent inadvertent retraction of the landing gear on the ground, a safety pressure switch is installed in the pitot system to deactivate the hydraulic pressure pump circuit when the impact air pressure is below 59 to 63 knots.

WARNING

Never rely on the safety switch to keep the gear down during taxi, take-off roll, or landing roll. Always make certain that the landing gear switch handle is in the down position during these operations.

WARNING HORN

If either or both throttles are retarded below an engine setting sufficient to sustain flight and the landing gear is retracted, the landing gear warning horn will sound intermittently. Also, when the flaps are extended beyond approximately 16°, the warning horn will sound, regardless of throttle position, if the landing gear is not down and locked.

WARNING HORN "Q" SWITCH

An optional "Q" switch is available to prevent the gear warning horn from sounding with the throttle(s) retarded and the landing gear retracted. In order for the "Q" switch to interrupt the gear warning horn, the airspeed must be above 99 to 106 KIAS and the flaps must be retracted above approximately 16°.

WARNING HORN SILENCE BUTTON

An optional gear warning horn silence button allows the pilot to manually silence the warning horn with either throttle retarded, the landing gear retracted, and the flaps retracted above approximately 16°. The push-to-silence button is located next to the landing gear control switch and is placarded "GEAR HORN SILENCE". A red light in the button illuminates when the gear horn silence system is activated.

When either throttle is retarded sufficiently to activate the gear warning horn, the horn may be silenced with the button. If the other throttle is then retarded, the warning horn will again sound and cannot be silenced. After a single throttle has been retarded and the resulting warning horn silenced with the button, readvancing the throttle resets the warning horn and it will again sound when either throttle is retarded. The warning horn is also reset when the landing gear are lowered. When the flaps are extended beyond approximately 16°, the button will not silence the warning horn.

CIRCUIT BREAKER

The landing GEAR MOTOR circuit breaker and the landing GEAR CONTROL circuit breaker are located on the right subpanel. The circuit breakers are the pull-and-reset type and will pop out under overload conditions.

EMERGENCY EXTENSION

The landing gear can be manually extended by turning the hydraulic pressure bypass valve 90° counterclockwise. The valve is located under the access door on the floor in front of the pilot's seat. When the system pressure is released, the gear will fall into the down-and-locked position. The emergency extension procedure is outlined in the EMERGENCY PROCEDURES section.

INTENTIONALLY LEFT BLANK

BRAKES

The brakes on the main landing gear wheels are operated by applying toe pressure to the top of the rudder pedals. The parking brakes push-pull control is located on the right sub-panel just left of the flap switch. To set the parking brakes, pull the control out and pump both toe pedals until solid resistance is felt. Push the control in to release the brakes.

The hydraulic brake fluid reservoir is located on the left side of the forward cabin bulkhead and is accessible through the nose compartment. Fluid level is checked with the dipstick attached to the reservoir cap. The brakes require no adjustment, since the pistons move outward to compensate for lining wear.

CAUTION

Install wheel chocks and release the parking brake if the airplane is to be left unattended. Changes in ambient temperatures can cause the brakes to release or exert excessive pressures.

BAGGAGE COMPARTMENT

The aft baggage compartment is accessible through the utility door on the left side of the fuselage. This area extends aft of the rear seats to the rear bulkhead. Loading within the baggage compartment must be in accordance with the data in the **WEIGHT AND BALANCE** section. All baggage must be secured with the nylon straps, which are provided in the baggage compartment.

The hat shelf, located near the top of the aft cabin enclosure, provides an area for light miscellaneous articles. Both the baggage compartment and the hat shelf are accessible in flight.

WARNING

Do not carry hazardous material anywhere in the airplane.

Do not carry children in the baggage compartment.

SEATS, SEAT BELTS, AND SHOULDER HARNESSSES

SEATS

To adjust either of the front seats, pull the release knob located below the left forward seat corner (pull to the right, then up) and slide the seat forward or aft to the desired position. Make certain each seat is locked securely in place after adjustment. The backs of all individual seats can be placed in any of three positions by means of a release lever located on the side of each seat. Headrests are available for each of the individual seats. Outboard armrests for the front seats are attached to the cabin doors.

SEAT BELTS

All seats are provided with seat belts having a lever-action, quick-release, metal buckle. The seat belt length can be shortened or lengthened by allowing the excess belt to pull through the end of the buckle. Holding the buckle at a right angle to the belt releases the binding action, allowing the belt to slip.

SHOULDER HARNESSSES

The shoulder harness is a standard installation for all seats and should be used with the seats in the upright position. The spring loading at the inertia reel keeps the harness snug, but will allow normal movement during flight operations. The inertia reel is designed with a locking device that will secure the harness in the event of sudden forward movement or an impact action. The strap is worn over the shoulder and down across the body, where it is fastened by a metal loop to the seat belt buckle. The inertia reels for the front and middle seats are attached to the lower cabin sidewall structure at the aft edge of the respective seat. The inertia reel is covered with an escutcheon, and the strap runs up from the reel to a looped fitting attached to the window frame just aft of the seat. For stowing these shoulder harness straps, stowage attach points are provided adjacent to the inertia reel on the cabin sidewall.

WARNING

The seat belt is independent of the shoulder harness; however, the shoulder harness may be used only when the seat belt is fastened.

Occupants shorter than 4'7" are not to use shoulder harness.

DOORS AND EXITS

FORWARD CABIN DOORS

The airplane has a conventional cabin door on each side of the fuselage adjacent to the forward seats. When closed, the outside cabin door handle is spring-loaded to fit into a recess

in the door. The door can be locked with a key. To open the door from the outside, lift the handle from its recess and pull until the door opens. To close the cabin door from the inside, grasp the armrest attached to the door and firmly pull the door closed. Opening the storm window will alleviate pressure inside the cabin as the door is being closed. Press firmly outward at the upper aft edge of the door. If any movement of the door is detected, completely open the door and close again following the above instructions. To open the door from the inside, grasp the door release handle and pull until door latch releases.

AFT UTILITY DOOR

The aft utility door on the left side of the fuselage is provided for loading baggage into the aft cabin area. This door can be opened from outside the airplane or from the inside. To open the door from the outside, lift the handle from its recess and pull until the door opens. To open the door from the inside, pull out on the locking pin adjacent to the door handle, then rotate the handle counterclockwise (approximately $\frac{1}{4}$ turn) until the door opens. The door handle is equipped with a keyhole and can be locked, as desired.

EMERGENCY EXITS

An emergency exit can be accomplished through either of the forward cabin doors, or the aft utility door.

CONTROL LOCK

A control lock is provided with the loose tools. When installed on ME-1 thru ME-338 it prevents movement of the control column and impairs access to the magneto/start

switches. On Serials ME-339 and after, and airplanes prior to ME-339 complying with BEECHCRAFT Service Instructions No. 1136, the control lock prevents movement of the control column, impairs access to the magneto/switches, and also prevents movement of the throttles and rudder pedals.

To Install the Control Lock (Serials ME-1 thru ME-338):

1. Rotate control wheel and move control column so the holes in the control column hanger and the control column will align to accept the pin.
2. Push the control column lock pin through the hole provided in the control column hanger and into the hole in the underside of the control column tube assembly.
3. Ensure positive retention of the lock pin by positioning the hook over the control column.

WARNING

Before starting the engines, remove the control lock by reversing the above procedure.

To Install the Control Lock (ME-339 and after, and airplanes prior to ME-339 complying with BEECHCRAFT Service Instructions No. 1136):

1. Install throttle control lock on the engine control quadrant.
2. Install rudder lock by inserting the upright tabs of the rudder lock between the bottom of the rudder pedals and the rudder bars.
3. Rotate the control wheel and move control column so the holes in the control column hanger and the control column will align to accept the pin. Push the control column lock pin through the hole provided in the control column hanger and into the hole in the

INTENTIONALLY LEFT BLANK

underside of the control column tube assembly. Ensure positive retention of the lock pin by positioning the hook over the control column.

NOTE

Tension on the cable between the rudder lock and the control column lock holds the rudder lock in place.

WARNING

Before starting the engines, remove the control lock by reversing the above procedure.

ENGINES

Two direct-drive, four-cylinder, horizontally opposed, Avco Lycoming engines are installed. An O-360-A1G6D (clockwise rotating as viewed from the pilot's seat) engine is mounted on the left wing, and an LO-360-A1G6D (counterclockwise rotating) engine is mounted on the right wing. Each engine is rated at 180 horsepower at 2700 rpm.

ENGINE CONTROLS

THROTTLE, PROPELLER, AND MIXTURE

The control levers are grouped along the upper portion of the control console. Pushing forward on a control lever increases its appropriate function, pulling back decreases it. The knobs

on the levers are shaped to standard government configuration so they can be identified by touch. The controls are centrally located for ease of operation from either the pilot's or the copilot's seat. A controllable friction knob, located to the right of the control levers, is provided to prevent creeping of the control levers.

ENGINE INSTRUMENTATION

Most of the engine instruments are located in the center of the instrument panel. This group includes left and right instruments for fuel quantity, fuel pressure, oil pressure, oil temperature, cylinder head temperature, and loadmeters. The alternator-out annunciator lights for each alternator, and the test switch for the lights, are located adjacent to the loadmeters. The balance of the engine instruments, located above the left subpanel, include a dual-indicating manifold pressure gage, tachometers, and a dual-indicating exhaust gas temperature indicator.

MANIFOLD PRESSURE GAGE

The dual-indicating manifold pressure gage indicates the pressure of the fuel/air mixture entering the engine cylinders of each engine, and is calibrated in inches of mercury.

EXHAUST GAS TEMPERATURE INDICATOR (EGT)

This installation provides for a sensitive and rapid indication of exhaust gas temperature to assist in adjusting the fuel/air mixtures during cruise. Procedures pertaining to leaning the mixture using the EGT indicator are contained in the NORMAL PROCEDURES section.

ENGINE BREAK-IN INFORMATION

New engines have been carefully run-in by the engine manufacturer. However, the engines should be operated on straight mineral oil for a minimum of 50 hours or until oil consumption stabilizes. After the first 25 hours of operation, drain and replace the mineral oil. A change to an approved engine oil should be made after the break-in period. Refer to Lycoming Engine Operator's Manual.

NOTE

In order to promote proper ring seating, cruise power settings of 65% to 75% should be used until a total of 50 hours has accumulated or until oil consumption has stabilized. This recommendation is applicable to in-service engines following cylinder replacement or top-overhaul of one or more cylinders, as well as to new engines.

ENGINE LUBRICATION

The engines are equipped with a wet-sump, pressure-type oil system. Each engine sump has a capacity of 8 quarts. The oil level may be checked through the access door in each engine cowling. A calibrated dipstick attached to the filler cap indicates the oil level. Due to the canted position of the engines, the dipsticks are calibrated for either right or left engines and are not interchangeable.

Oil operating temperatures are controlled by an automatic thermostat bypass control. The bypass control will limit the oil flow through the oil cooler when operating temperatures are below normal, and will permit the oil to bypass the cooler if it should become blocked.

ENGINE ICE PROTECTION

The possibility of induction system icing is reduced by the carburetor air heat system.

CARBURETOR HEAT

The carburetor heat control levers are located just below the control console on the pedestal. The levers have two placarded positions: OFF - ON. When the levers are in the OFF (up) position, cold and filtered air enters the induction system. Placing the levers in the ON (down) position allows heated and unfiltered air to enter the induction system to alleviate the possibility of carburetor ice. Carburetor air heat should be used in accordance with the recommendations in the NORMAL PROCEDURES section.

INDUCTION AIR

Induction air is available from filtered ram air or unfiltered carburetor heat air. Filtered ram air enters from above the engine inside the nacelle area.

COWL FLAPS

The manual cowl flaps are controlled by separate levers located just below the carburetor heat controls on the pedestal. Each control lever has three placarded positions: CLOSE (up) - HALF - OPEN (down). The control levers allow the cowl flaps to be positioned so that the desired cylinder head temperatures can be maintained.

STARTERS

The magneto/start switches are located on the subpanel to the left of the pilot's control column and incorporate R (right), L (left), and BOTH magneto positions in addition to the OFF and START positions. After activation of the starter, the spring-loaded switch returns to the BOTH position when released. Also, the switches include a PUSH TO PRIME position that activates the electric fuel priming function for the purpose of supplying additional fuel to the engine during starting.

■ The warning light placarded STARTER ENGAGED (ME-

333, ME-346 and after) is located between the Left Magneto/Start and Right Magneto/Start switches on the pilot's left subpanel. The starter engaged warning light will illuminate whenever electrical power is being supplied to the starter. If the light remains illuminated after starting, the starter relay has remained engaged and loss of electrical power may result.

PROPELLERS

The airplane is equipped with two Hartzell, 76-inch diameter, constant-speed, full-feathering, two-blade propellers. Propeller rpm is controlled by the engine-driven propeller governor which regulates hydraulic oil pressure to the hub. The propeller controls, on the control console, allow the pilot to select the governor's rpm range. Springs and dome air pressure, aided by counterweights, move the blades to high pitch. Engine oil under governor-boosted pressure moves the blades to the high rpm (low pitch) position.

The propellers should be cycled occasionally during cold weather operation. This will help maintain warm oil in the propeller hubs so that the oil will not congeal.

FUEL SYSTEM

The airplane is designed for operation on grade 100 (green) or 100LL (blue) aviation gasoline. The fuel system is an ON - CROSSFEED - OFF arrangement. The fuel selector panel, located on the lower portion of the center pedestal, contains the fuel selector levers for each engine.

The fuel is drawn from the respective tank through the fuel strainer and to the fuel selector valve, located aft of the firewall in each nacelle. From the fuel selector valve, the fuel passes through a check valve and then through the engine-driven fuel pump and delivered to the carburetor. The cabin heater, located in the nose compartment, uses fuel (approximately 2/3 gallon per hour) from the right wing tank fuel system only.

FUEL TANKS

The fuel system consists of a bonded leading-edge fuel tank located outboard of the nacelle in each wing. The fuel tank in each wing has a capacity of 51.5 gallons for a total fuel capacity of 103 gallons (100 gallons usable). Each wing is serviced through a single filler located in the outboard portion of each wing. The filler neck of each tank contains a visual measuring tab which facilitates partial filling of the fuel system. When the fuel level reaches the bottom of the tab, it indicates 30 (28.5 usable) gallons of fuel in that tank. The center mark on the tab indicates 40 (38.5 usable) gallons of fuel and the mark at the top indicates a full tank of 51.5 (50 usable) gallons of fuel.

FUEL SELECTOR VALVES

The fuel selector valves are located in each nacelle on the outboard side just forward of the wing leading edge. The valve is of the rotary type and is operated by push-pull cable from the floor console between the front seats. The valve has three positions, ON - CROSSFEED - OFF, which are determined by detents in the valve. The floor console has a slot for each selector valve lever, with notches which correspond to the valve detents.

NOTE

During operation, make certain fuel selector valves are in detent in the ON position. This can be determined by moving the levers slightly within the detent notch. Operation with the valve slightly out of detent could result in fuel transferring from one wing tank to the other.

The fuel selector valves also function as a preflight drain point and firewall fuel shutoff. The lower portion of the valve serves as a sediment bowl and contains the fuel strainer screen.

FUEL SYSTEM SCHEMATIC

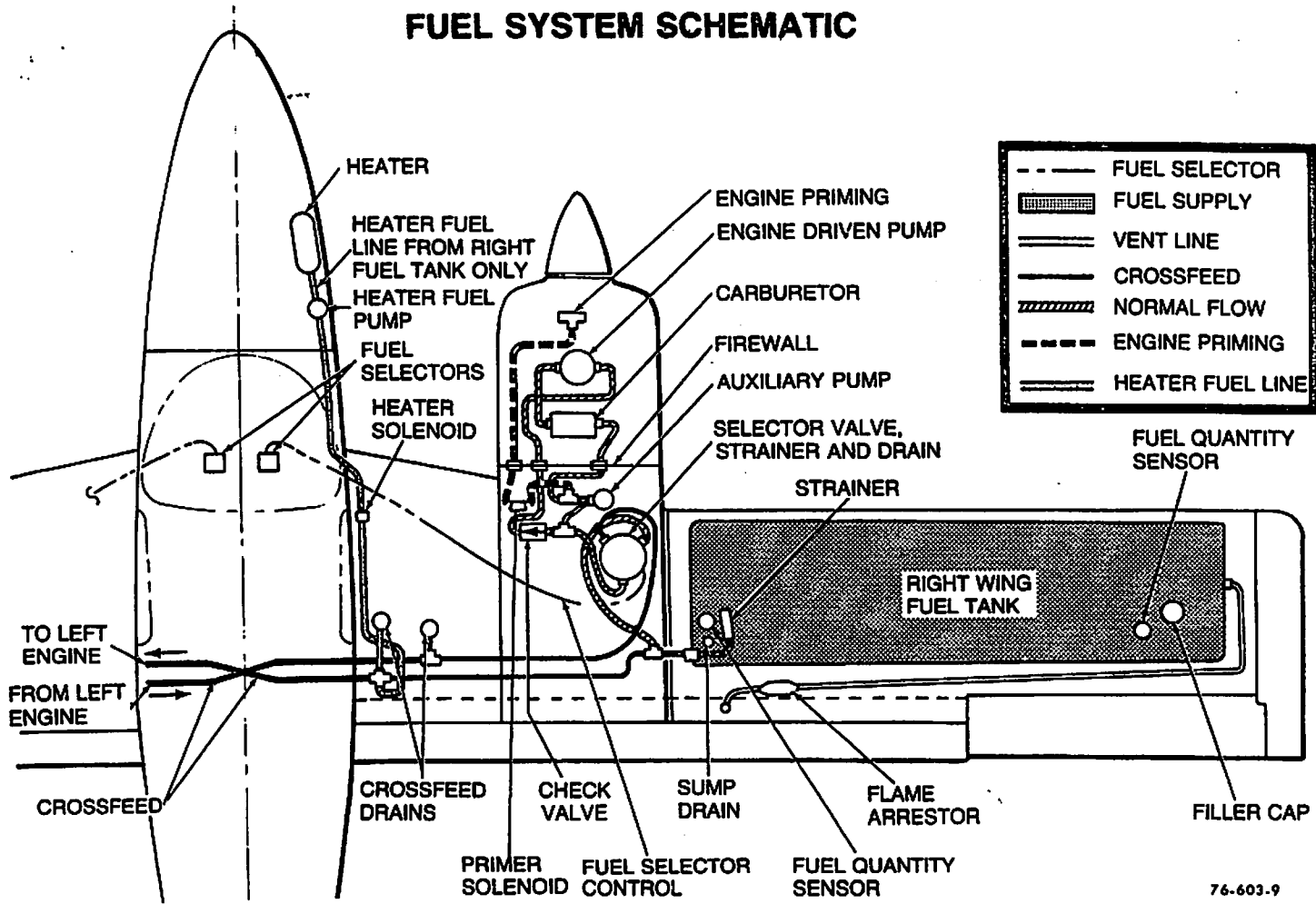

76-603-9

FUEL DRAINS

The fuel system is drained at eight locations, four on each wing. A flush sump drain valve is located outboard of each nacelle on the underside of each wing tank. A drain is also provided for the fuel selector valve, located in the outboard underside of each nacelle aft of the firewall. Two flush drains are located inboard of each main gear wheel well for draining the crossfeed fuel lines.

The fuel selector valve drains are actuated manually by pushing up, approximately one-quarter inch, on the lower portion of the drain valve. All other fuel drains are flush-type valves and are actuated by using the combination fuel drain/emergency landing gear tool provided with the loose tools and equipment. Flush-type fuel drains are actuated by pushing in on the valve and then releasing when the desired amount of fuel has been drained. These drain valves can be locked open for the purpose of fuel off-loading or for totally draining the fuel system. Pushing in and turning counterclockwise will lock the drains in the open position. To close, turn clockwise and release.

FUEL QUANTITY INDICATORS

Fuel quantity is measured by two float-operated sensors located in each wing tank system. The sensors transmit electrical signals to the individual indicators, located on the instrument panel, which indicate the amount of fuel remaining in each tank.

AUXILIARY FUEL PUMPS

The electric auxiliary fuel pumps, one for each engine, are located in the nacelle just aft of the firewall. They are controlled by separate rocker-type ON-OFF switches, placarded **AUX FUEL PUMP - L ON - R ON**, located on the pilot's subpanel. The auxiliary fuel pumps provide pressure for

priming, starting, taxiing, takeoff, and landing. Also, the auxiliary fuel pump provides sufficient pressure for continued engine operation in case the engine-driven fuel pump becomes inoperative.

ENGINE PRIMING

Each engine is equipped with a three-point (no. 1, 2, and 4 cylinders) fuel priming system. The magneto/start switches incorporate a PUSH TO PRIME function to aid in engine starting. The BATTERY MASTER and the AUX FUEL PUMP (L or R) switches must be turned on prior to activating the fuel priming system. The PUSH TO PRIME switch may be actuated in either the BOTH or START position. Pushing in on the magneto/start switch activates a solenoid, located behind the firewall in each nacelle, and supplies fuel directly into the no. 1, 2, and 4 cylinders for engine priming. Engine priming should be used in accordance with the recommendations in the NORMAL PROCEDURES section.

FUEL CROSSFEED

The fuel lines for the engines are interconnected by crossfeed lines. During normal operation each engine uses its own fuel pumps to draw fuel from its respective wing fuel system. However, on emergency crossfeed operations, either engine can consume all the available fuel from the opposite side.

The fuel crossfeed system is provided for use during level flight, emergency conditions only. The system cannot transfer fuel from one wing system to the other. The procedure for using the crossfeed system is described in the EMERGENCY PROCEDURES section.

FUEL REQUIRED FOR FLIGHT

Flight planning and fuel loading are facilitated by the use of fuel quantity indicators that have been coordinated with the usable fuel supply. It is the pilot's responsibility to ascertain

that the fuel quantity indicators are functioning and maintaining a reasonable degree of accuracy, and be certain of ample fuel for each flight. A minimum of 9 gallons of fuel is required in each wing system before takeoff.

ELECTRICAL SYSTEM

The system circuitry is the single-wire, ground-return type, with the airplane structure used as the ground return. The alternator switches, battery switch, magneto/start/prime switches, and auxiliary fuel pump switches are located on the pilot's subpanel. This panel contains most of the electrical system switches and switch-type circuit breakers. Each is placarded as to its function. The right subpanel contains the protective circuit breakers for the various electrical systems, and all avionics circuit breakers.

BATTERY

One 24-volt, 15.5-ampere-hour, lead-acid battery (*ME-183 and after*) or one 12-volt, 35-ampere-hour, lead-acid battery (*ME-1 thru ME-182*) is installed in a battery box in the aft fuselage compartment. An optional installation (*ME-183 and after*) provides two 12-volt, 25-ampere-hour, lead-acid batteries, electrically connected in series and installed in the battery box. Battery servicing procedures are described in the HANDLING, SERVICING, and MAINTENANCE section.

The battery box is fitted with a lid for access to the battery or batteries. The lid is held in place with two lift-to-release latches.

Battery fumes and gases are vented to the outside through two vents in the lower fuselage skin below the battery box. The vents are so designed that there is a flow of air from the vent to the top of the box and out through the vent at the bottom of the box.

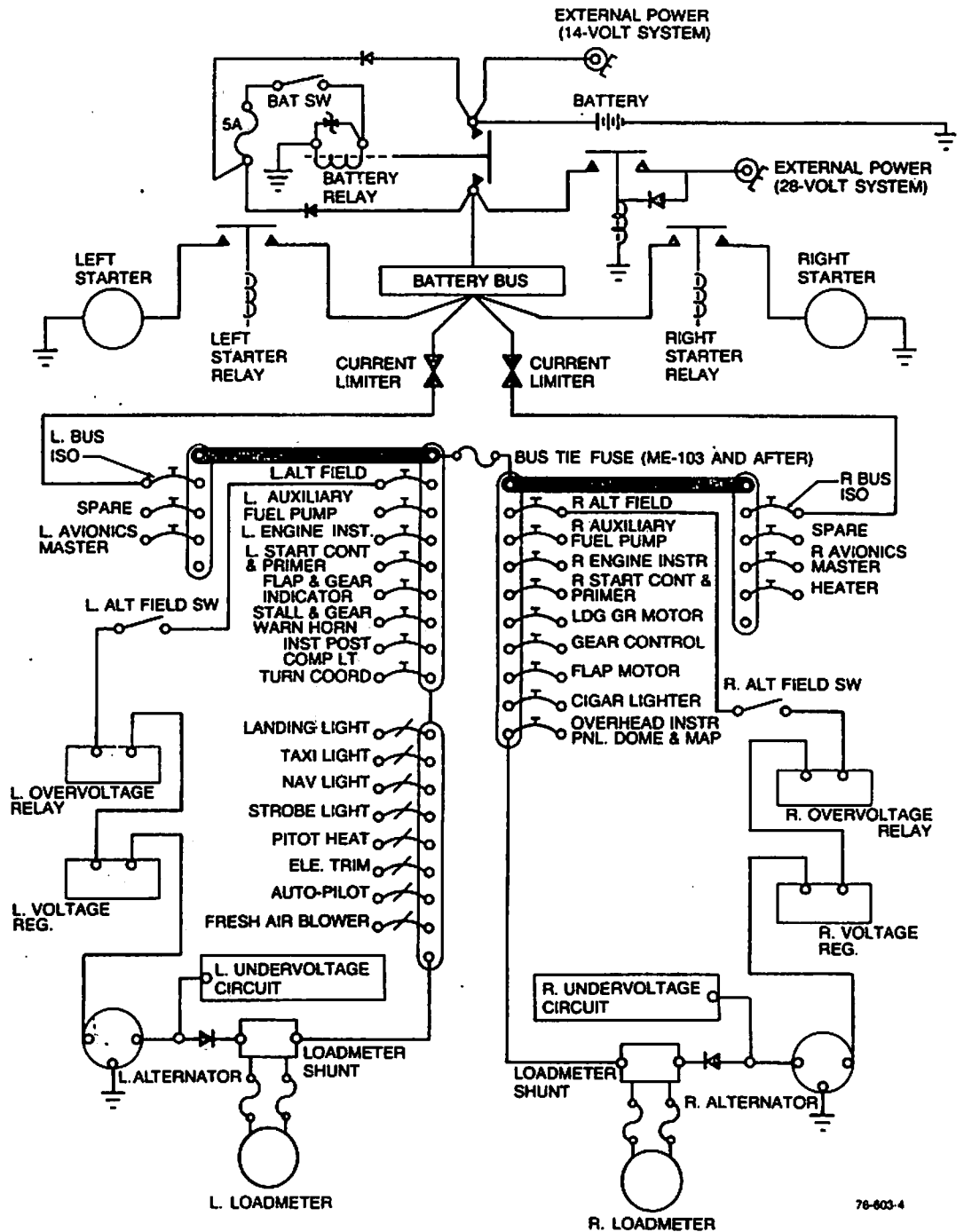

76-803-4

POWER DISTRIBUTION SCHEMATIC

ALTERNATORS

Two 55-ampere, 28-volt, belt-driven alternators (*ME-183 and after*) or two 60-ampere, 14-volt, belt-driven alternators (*ME-1 thru ME-182*) are installed in the airplane.

The output of each alternator is controlled by a separate voltage regulator. The alternator systems are completely separate, except for the BUS TIE FUSE (on airplanes ME-103 and after), the mutual tie to the battery bus through two bus isolation circuit breakers, and the paralleling circuit between the regulators. The bus-isolation circuit breakers are used to isolate Bus 1 and Bus 2 from the battery bus circuit. The regulators automatically maintain the bus voltage at a set value for all loads up to the alternator rating. The voltage regulators also maintain approximately equal load sharing between the two alternators.

The self-excitation load capability of the alternators is directly related to engine RPM. The self-excitation feature will not come on until approximately 1200 to 1400 RPM, with a load capability of approximately 50%. However, it will remain on as engine speed is reduced to approximately 850 to 1000 RPM. A maximum load capability of approximately 80% should be obtainable at approximately 2300 RPM engine speed.

CAUTION

During an in-flight emergency, under no condition, shall more load be applied than is absolutely necessary for safe flight condition. Initiation of any flight using the self-excitation feature is strictly prohibited.

Individual alternator output is indicated by the two loadmeters (as opposed to the charge/discharge-type ammeter) located on the instrument panel. The loadmeters give a percentage reading of the load on the system.

There are two pairs of alternator-out warning lights, each pair placarded **ALTERNATOR OUT - UNDER/OVER VOLTAGE**. Each pair is adjacent to its corresponding loadmeter, located on the instrument panel. Anytime either alternator voltage is $4 \pm .1$ volts (28-volt system) or $2 \pm .1$ volts (14-volt system) below the bus voltage, the corresponding undervoltage alternator-out light will illuminate. When the battery is turned on with both alternators off, both alternator-out undervoltage lights will illuminate. The alternator-out overvoltage light (one for each alternator) will illuminate when the corresponding overvoltage relay is actuated. The overvoltage relay opens the affected alternator field, and the affected alternator voltage will drop to zero. The alternator-out lamps can be tested by pressing the **TEST** switch located adjacent to the lamps.

STARTERS

The starters are relay-controlled and are actuated by rotary-type, momentary-on switches, incorporated in the magneto/start/prime switches located on the pilot's subpanel. To energize the starter circuit, hold the magneto/start/prime switch in the **START** position.

STARTER ENGAGED WARNING LIGHT (ME-333, ME-346 AND AFTER)

The warning light placarded STARTER ENGAGED will illuminate whenever electrical power is being supplied to the starter. If the light remains illuminated after starting, the starter relay has remained engaged and loss of electrical power may result. The battery and alternator switches should be turned off if the light remains illuminated after starting. If the light does not illuminate during starting, the indicator system is inoperative and the loadmeters should be monitored to ensure that the starter does not remain energized after starting.

EXTERNAL POWER

The external power receptacle is located either on the right (ME-1 through ME-440) or on the left (ME-441 and after) side of the fuselage, just aft of the cabin area. A negatively grounded external power source may be used for engine starting or for ground electrical system checks. Airplanes equipped with 14-volt systems (ME-1 through ME-182) require a power unit setting of 14 volts, $\pm .2$ volts. Airplanes equipped with 28-volt system (ME-183 and after) require a power unit setting of 28 volts, $\pm .2$ volts.

CAUTION

On 14-volt airplanes, the power pin for external power is connected directly to the battery and continually energized. Turn off alternator switches, all electrical and avionics switches, and turn on battery switch before connecting the auxiliary power unit plug. Assure correct polarity (negative ground) before connecting auxiliary power unit.

CAUTION

On 28-volt airplanes, a reverse polarity diode protection system is between the external power receptacle and the main bus. With external power applied, the bus is powered. Turn on the battery switch only with all other switches including avionics switches off before connecting the auxiliary power unit. Assure correct polarity before connecting external power.

When auxiliary power is desired, connect the clamps of the power cable to the remote power source, ensuring proper polarity. Turn OFF the ALT switches and ensure that all avionics equipment is OFF, and then turn ON the BATT switch. Insert the power cable plug into the receptacle, turn on auxiliary power unit, and start engine using the normal starting procedures.

INTENTIONALLY LEFT BLANK

INTENTIONALLY LEFT BLANK

LIGHTING SYSTEMS

INTERIOR LIGHTING

Lighting for the instrument panel is controlled by two rheostat switches located on the copilot's subpanel to the right of the control console. One switch, placarded INSTR FLOOD, controls the intensity of the overhead instrument flood light and the overhead map light. The other switch, placarded POST LIGHTS, adjusts the intensity of all post lights installed, magnetic compass light, and the internally lit engine instruments. The cabin dome light is controlled by the switch located adjacent to the light.

EXTERIOR LIGHTING

The switches for all exterior lights are located on the lower portion of the pilot's subpanel. Each circuit is protected by a circuit-breaker-type switch.

The exterior lights consist of a landing light on the outboard leading-edge portion of the left wing, a taxi light on the outboard leading-edge portion of each wing, navigation lights on the wing tips and empennage, and a strobe light located on each wing tip. For longer battery and lamp life, use the landing light and the taxi lights sparingly; avoid prolonged operation which could cause overheating during ground maneuvering.

NOTE

Particularly at night, reflections from anti-collision lights on clouds, dense haze, or dust can produce optical illusions and intense vertigo. Such lights, when installed, should be turned off before entering an overcast; their use may not be advisable under instrument or limited VFR conditions.

ENVIRONMENTAL SYSTEMS

CABIN HEATING

A 45,000 Btu-per-hour combustion air heater, located on the right side in the nose compartment, provides heated air for cabin warming and windshield defrosting. The heater system consists of a combustion air heater, three-position control switch, three push-pull control knobs, heater circuit breaker, manual reset limit (overheat) switch, combustion air blower, ventilation air blower, and a duct thermostat.

Fuel for the combustion heater is routed from the right wing fuel system, through a solenoid valve, to the heater fuel pump located under the heater, and into the combustion chamber of the heater. Fuel consumption of the heater is approximately $\frac{2}{3}$ gallons per hour and should be considered during flight planning.

NOTE

The fuel solenoid is energized only if the duct thermostat, which controls the heater, requires a higher temperature.

Three outlets are located in the cabin to distribute the heated air into the cabin. One outlet is located on the lower forward cabin bulkhead and provides heated air for the pilot and copilot compartment. The second outlet is located between the pilot and copilot seats and faces aft, to provide heated air to the aft cabin area. The defrost duct is routed from the heater to the windshield outlet for windshield defrosting.

Section VII
Systems Description

BEECHCRAFT
Duchess 76

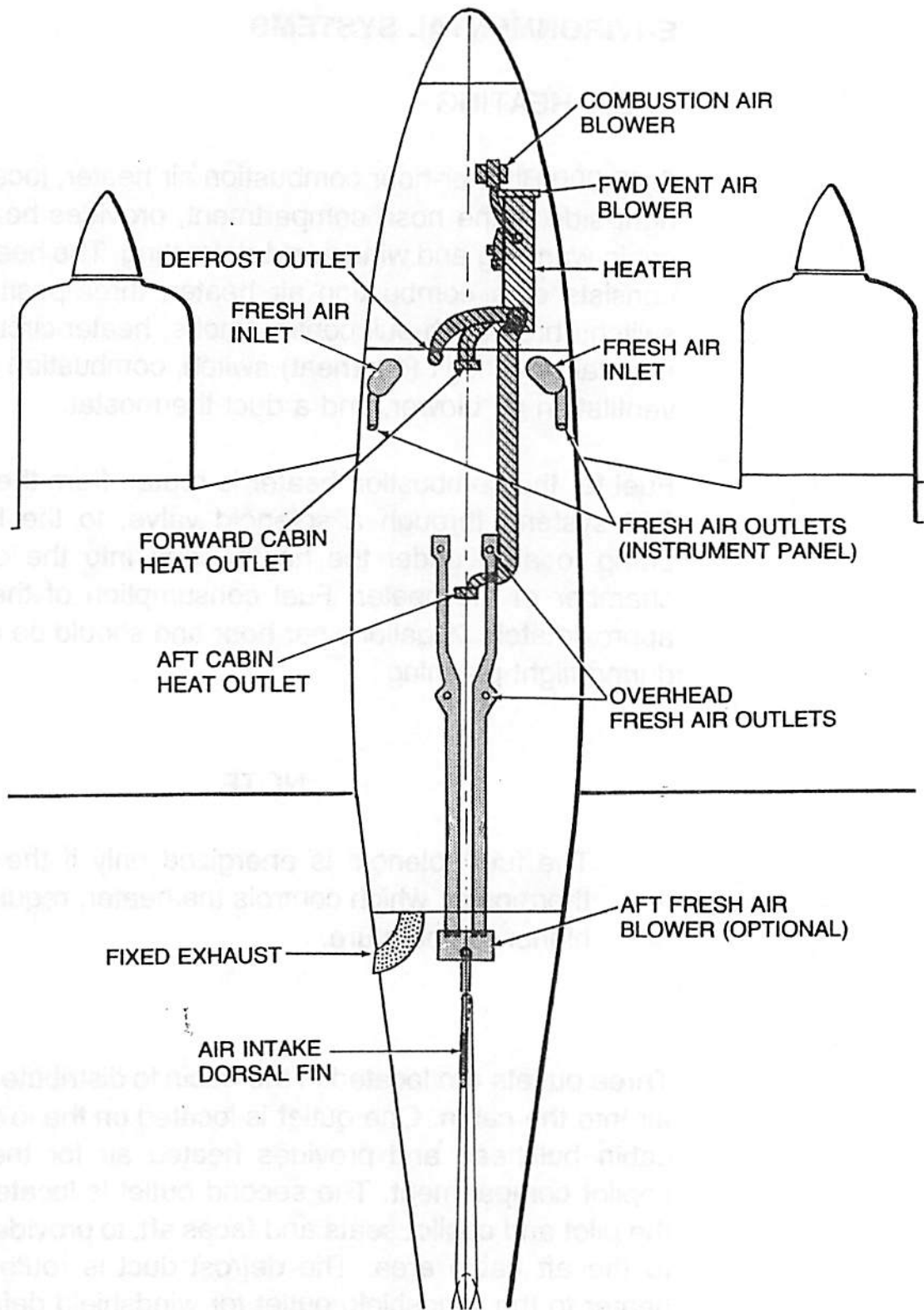

ENVIRONMENTAL SCHEMATIC

The manual reset limit (overheat) switch (inaccessible during flight), located on the heater, shuts off the heat system in case the discharge temperature reaches 300° F.

CAUTION

The entire system should be inspected and the malfunction determined and corrected before re-setting the overheat switch.

HEATER OPERATION

1. The three-position switch on the pilot's subpanel, placarded HEATER - ON, BLOWER ONLY, OFF, must be in the ON position to place the heating system in operation.
2. The push-pull knob on the left sidewall, placarded DEFROST - PULL ON, controls the amount of air required for windshield defrosting.
3. The push-pull knob, located below the defrost knob, placarded CABIN AIR - PULL OFF, controls the amount of air entering the cabin from the heater. Pulling the knob more than approximately one-half closed deactivates the heater in order to prevent heater overtemp.

NOTE

For maximum heat, the CABIN AIR control can be pulled partially out to reduce the volume of incoming cold air and permitting the heater to raise the temperature of the admitted air. However, if the CABIN AIR control is pulled out more than halfway, the heater will not operate.

4. The push-pull knob, located below the cabin air control, placarded **CABIN TEMP - PULL TO INCREASE**, controls the temperature of the air entering the cabin. Pulling aft on the knob increases the temperature at which the duct thermostat switch opens (controlling the heater).

CABIN VENTILATION

In flight, to provide unheated air through the same outlets used for heating, push the **CABIN AIR** and **CABIN TEMP** controls forward. The air intake for this system is located on the right side of the nose compartment.

For ventilation through these same outlets during ground operation, push the **CABIN AIR** control forward and place the three-position switch, on the pilot's subpanel, in the **BLOWER ONLY** position. The **BLOWER ONLY** position is for ground operation only and will shut off the blower when the landing gear is retracted.

Fresh ram air is also provided through an outlet located on each side of the instrument panel. Fresh air for these outlets enters the two vents located immediately forward of the windshield. Rotation of the outlets controls the flow of air.

OVERHEAD FRESH AIR OUTLETS

Fresh air from the intake on the left side of the dorsal fin is ducted to the individual outlets located above each seat. The volume of air at each outlet can be regulated by rotating the outlet. Each outlet can be positioned to direct the flow of air as desired. An optional fresh air blower for this system is located in the aft fuselage. The blower is controlled by the

circuit breaker switch on the pilot's subpanel placarded CABIN AIR BLOWER. The blower is designed for ground operation and climb-out and should be turned off during cruise.

EXHAUST VENT

A fixed cabin exhaust vent is located on the left side of the aft fuselage and provides for flow-through ventilation.

PITOT AND STATIC SYSTEMS

The pitot and static systems provide a source of impact and static air for the operation of the flight instruments.

PITOT SYSTEM

A standard pitot tube for the pilot's flight instruments is located on the outboard portion of the left wing leading edge. The optional pitot tube (ME-44 and after) for the copilot's flight instruments is located on the outboard portion of the right wing leading edge.

PITOT HEAT

A heating element is installed in the pitot mast and is controlled by the rocker-type switch located on the pilot's subpanel. The switch is placarded PITOT HEAT - ON, and should remain off during ground operations except for testing or for short intervals of time to remove ice or snow from the mast. One switch controls the heating elements in both pitot masts. ■

STATIC SYSTEM

Static air is taken from a flush static port located on each side of the aft fuselage. The static air is routed to the rate-of-climb indicator, altimeter, and airspeed indicator.

The alternate static air source is designed to provide a source of static pressure to the instruments from inside the fuselage should the outside static air ports become blocked. An abnormal reading of the instruments supplied with static air could indicate a restriction in the outside static air ports. A lever on the lower sidewall adjacent to the pilot, is placarded OFF NORMAL - ON ALTERNATE. When it is desired or required to use this alternate source of static air, select the ON ALTERNATE position. To recognize the need and procedures for the use of alternate static air, refer to the EMERGENCY PROCEDURES section. Airspeed Calibration and Altimeter Correction graphs are in the PERFORMANCE section.

The static air plumbing is drained by placing the lever in the ON ALTERNATE position momentarily and then returning it to the OFF NORMAL position.

PRESSURE SYSTEM

Pressure for the flight instruments and autopilot (if installed) is supplied by two, engine-driven, dry, pressure pumps interconnected to form a single system. If either pump fails, check valves automatically close and the remaining pump continues to operate all gyro instruments. A pressure gage on the pilot's subpanel indicates pressure in inches of mercury. Two red buttons on the pressure gage serve as source failure indicators, each for its respective side of the system. The pressure system incorporates a central filter which protects the instruments. This disposable filter is installed in the nose compartment and must be replaced in accordance with the recommendations in the SERVICING section.

STALL WARNING

The stall warning system consists of a sensing vane installed on the leading edge of each wing, a circuit breaker located on the right subpanel placarded STALL & GEAR WARN, and a stall warning horn in the overhead speaker console. The stall warning horn will sound a warning signal while there is time for the pilot to correct the attitude. The horn is triggered by the sensing vane on the left wing anytime the flaps are above approximately 16°. When the flaps are extended beyond approximately 16°, the vane on the right wing will activate the warning horn.

NOTE

With the BATT and ALT switches in the OFF position, the stall warning horn is inoperative.

HANDLING, SERV. & MAINT

**SECTION VIII
HANDLING, SERVICING
AND MAINTENANCE**

TABLE OF CONTENTS

| <i>SUBJECT</i> | <i>PAGE</i> |
|---|-------------|
| Introduction to Servicing | 8-3 |
| Publications | 8-4 |
| Airplane Inspection Periods | 8-4 |
| Preventive Maintenance That May Be Accomplished | |
| By a Certificated Pilot | 8-5 |
| Alterations or Repairs to Airplane..... | 8-5 |
| GROUND HANDLING | 8-6 |
| Towing..... | 8-6 |
| Parking | 8-6 |
| Tie-Down | 8-7 |
| Jacking | 8-8 |
| Prolonged Out of Service Care | 8-8 |
| Flyable Storage – 7 to 30 Days | 8-8 |
| External Power | 8-11 |
| SERVICING | 8-13 |
| Fuel System..... | 8-13 |
| Fuel Tanks | 8-13 |
| Fuel Drains..... | 8-13 |
| Fuel Strainers..... | 8-14 |
| Oil System | 8-14 |
| Battery | 8-16 |
| Tires..... | 8-17 |
| Shock Struts | 8-18 |

TABLE OF CONTENTS (CONTINUED)

| <i>SUBJECT</i> | <i>PAGE</i> |
|--|-------------|
| Brakes | 8-20 |
| Induction Air Filters | 8-20 |
| Instrument Air Filter..... | 8-21 |
| Propellers | 8-22 |
| Propeller Dome Air Pressure Setting..... | 8-22 |
| Propeller Blade Bearing Lubrication..... | 8-23 |
| MINOR MAINTENANCE..... | 8-23 |
| Cabin Heater..... | 8-23 |
| Alternators | 8-24 |
| Magnetos..... | 8-25 |
| Cleaning | 8-26 |
| Exterior Painted Surfaces..... | 8-26 |
| Windshield and Windows | 8-27 |
| Engine..... | 8-28 |
| Interior..... | 8-28 |
| Lubrication Points | 8-30 |
| Recommended Servicing Schedule..... | 8-38 |
| Consumable Materials | 8-46 |
| Approved Engine Oils | 8-48 |
| Lamp Bulb Replacement Guide | 8-51 |
| Overhaul and Replacement Guide..... | 8-52 |
| Wing Structure Inspection Schedule | 8-55 |

INTRODUCTION TO SERVICING

The purpose of this section is to outline the requirements for maintaining the airplane in a condition equal to that of its original manufacture. This information sets the time frequency intervals at which the airplane should be taken to a BEECHCRAFT Aero or Aviation Center or International Distributor or Dealer for periodic servicing or preventive maintenance.

The Federal Aviation Regulations place the responsibility for the maintenance of this airplane on the owner and the operator, who must ensure that all maintenance is done by qualified mechanics in conformity with all airworthiness requirements established for this airplane.

All limits, procedures, safety practices, time limits, servicing and maintenance requirements contained in this handbook are considered mandatory.

Authorized BEECHCRAFT Aero or Aviation Centers or International Distributors or Dealers can provide recommended modification, service, and operating procedures issued by both the FAA and Beech Aircraft Corporation, which are designed to get maximum utility and safety from the airplane.

If a question should arise concerning the care of the airplane, it is important to include the airplane serial number in any correspondence. The serial number appears on the model designation placard, attached to the right side of the fuselage adjacent to the inboard end of the flap. The placard is visible when the flaps are lowered.

PUBLICATIONS

The following publications are available through BEECHCRAFT Aero or Aviation Centers or International Distributors or Dealers.

1. Maintenance Manual
2. Parts Catalog
3. Wiring Diagram Manual
4. Continuous Care Inspection Guide
5. 100-Hour Inspection Guide
6. Service Instructions

Neither Service Publications, Reissues, nor Revisions are automatically provided to the holder of this handbook. For information on how to obtain "Revision Service" applicable to this handbook, consult a BEECHCRAFT Aero or Aviation Center or International Distributor or Dealer or refer to the latest revision of BEECHCRAFT Service Instructions No. 0250-010.

AIRPLANE INSPECTION PERIODS

1. FAA Required 100-Hour and/or Annual Inspections.
2. Continuous Care Inspection Guide.
3. See "Recommended Servicing Schedule" and "Overhaul or Replacement Schedule" for further inspection schedules.
4. Check the wing bolts for proper torque at the first 100 hour inspection and at the first 100 hour inspection after each reinstallation of the wing attach bolts.

PREVENTIVE MAINTENANCE THAT MAY BE ACCOMPLISHED BY A CERTIFICATED PILOT

1. A certificated pilot may perform limited maintenance. Refer to FAR Part 43 for the items which may be accomplished. To ensure proper procedures are followed, obtain a BEECHCRAFT Duchess 76 Maintenance Manual before performing preventive maintenance.
2. All other maintenance must be performed by licensed personnel.

NOTE

Pilots operating airplanes of other than U. S. registry should refer to the regulations of the country of certification for information on preventive maintenance that may be performed by pilots.

ALTERATIONS OR REPAIRS TO AIRPLANE

The FAA should be contacted prior to any alterations on the airplane to ensure that the airworthiness of the airplane is not violated.

NOTE

Alterations or repairs to the airplane must be accomplished by licensed personnel.

GROUND HANDLING

The three-view drawing shows the minimum hangar clearances for a standard airplane. Allowances must be made for any special radio antennas.

CAUTION

To ensure adequate propeller clearance, always observe recommended shock strut servicing procedures and tire inflation pressures.

TOWING

One person can move the airplane on a smooth and level surface with the hand tow bar. Attach the tow bar to the nose landing gear tow bar fitting. It is recommended to have someone in the airplane to operate the brakes.

CAUTION

Do not exert force on the propellers or control surfaces. When towing with a tug, limit turns to prevent damage to the nose gear. Do not tow when the main gear is obstructed by mud or snow.

PARKING

The parking brake push-pull control is located to the right of the control console on the copilot's subpanel. To set the

parking brakes, pull the control out and depress each toe pedal until firm. Push the control in to release the brakes.

NOTE

The parking brake should be left off and wheel chocks installed if the airplane is to remain unattended. Changes in ambient temperature can cause the brakes to release or to exert excessive pressures.

TIE-DOWN

It is advisable to nose the airplane into the wind. Three tie-down lugs are provided; one on the lower side of each wing, and a third at the rear of the fuselage.

1. Install the control lock assembly.
2. Chock the main wheels fore and aft.
3. Using nylon line or chain of sufficient strength, secure the airplane at the three points provided. **DO NOT OVER TIGHTEN**; if the line at the rear of the fuselage is excessively tight, the nose may rise and produce lift due to the angle of attack of the wings.
4. Release the parking brake.

If high winds are anticipated, a vertical tail post should be installed at the rear tie-down lug, and a tie-down line attached to the nose gear.

JACKING

Place a scissors jack under the axle to raise the individual gear for wheel and tire removal.

Jack pads are installed inboard of the main gears to facilitate landing gear retraction checks. Use of a tail stand, and the tail anchored to a ground tie-down or a weight of 450 lbs secured to the airplane tail tie-down ring, is required when jacking.

CAUTION

Never raise the airplane higher than necessary and use extreme caution when entering or leaving the airplane while it is on jacks.

The landing gear circuit breaker should be pulled and the emergency gear extension valve should be open to relieve pressure in the hydraulic system, in order to prevent inadvertent retraction of the landing gear when airplane is jacked.

PROLONGED OUT OF SERVICE CARE

The storage procedures are intended to protect the airplane from deterioration while it is not in use. The primary objectives of these measures are to prevent corrosion and damage from exposure to the elements.

FLYABLE STORAGE - 7 to 30 DAYS

MOORING

Place the airplane in a hangar. If the airplane cannot be placed in a hangar, tie down securely at the three tie-down

points provided on the airplane. Do not use hemp or manila rope. It is recommended a tail support be used to lightly compress the nose strut, which will reduce the wing angle of attack. Attach a line to the nose gear.

FUEL TANKS

Fill fuel tanks to capacity to minimize fuel vapor.

FLIGHT CONTROL SURFACES

Lock flight control surfaces with internal and external locks.

GROUNDING

Static ground airplane securely and effectively.

PITOT TUBE

Install pitot tube cover.

WINDSHIELD AND WINDOWS

Close all windows. It is recommended that covers be installed over the windshield and windows.

DURING FLYABLE STORAGE

In a favorable atmospheric environment the engine of an airplane that is flown intermittently can be adequately protected from corrosion by turning the engine over five revolutions by means of the propeller. This will dispel any beads of moisture that may have accumulated and spread the residual lubricating oil around the cylinder walls. Unless the airplane is flown, repeat this procedure every five days.

WARNING

Be sure the magneto/start switch is OFF, the throttle CLOSED, and mixture control in the IDLE CUT-OFF position before turning the propeller. Do not stand in the path of propeller blades. Also, ground running the engine for brief periods of time is not a substitute for turning the engine over by hand; in fact, the practice of ground running will tend to aggravate rather than minimize corrosion formation in the engine.

After 30 days, the airplane should be flown for 30 minutes or a ground runup should be made long enough to produce an oil temperature within the lower green arc range. Excessive ground runup should be avoided.

PREPARATION FOR SERVICE

Remove all covers, clean the airplane, and give it a thorough inspection, particularly landing gear, wheel wells, flaps, control surfaces, and pitot and static pressure openings.

Preflight the airplane.

If the airplane is to be stored longer than 30 days, refer to the appropriate airplane shop manual and Avco Lycoming Service Letter L180.

EXTERNAL POWER

To supply power for ground checks or to assist in starting, use only an external power source that is negatively grounded. The receptacle is located on the right side (ME-1 through ME-440), or on the left side (ME-441 and after), of the aft fuselage.

CAUTION

On 14-volt airplanes, the power pin for external power is connected directly to the battery and continually energized. Turn off alternator switches, all electrical and avionics switches, and turn on battery switch before connecting the auxiliary power unit plug. Assure correct polarity (negative ground) before connecting auxiliary power unit.

On 28-volt airplanes, a reverse polarity diode protection system is between the external power receptacle and the main bus. With external power applied, the bus is powered. Turn on the battery switch only with all other switches including avionics switches off before connecting the auxiliary power unit. Assure correct polarity before connecting external power.

Observe the following precautions when connecting an external power source:

1. Remove the protective cover from the external power receptacle of the airplane.

2. Use only an auxiliary power source that is negatively grounded which has a voltage of $28.0 \pm .2$ vdc (*ME-183 and after*). For *ME-1 through ME-182* voltage: $14.0 \pm .2$ vdc. If the polarity of the power source is unknown, determine the polarity with a voltmeter before connecting the unit to the airplane.
3. Before connecting an auxiliary power source, turn OFF all radio equipment, the alternator switches, and turn ON the battery switch.
4. Turn the auxiliary power source OFF prior to connecting the external power cable to the auxiliary power source. Connect the positive clamp of the cable to the positive terminal of the power source and the negative clamp to the negative terminal of the power source. (If a battery is used as the power source, connect the positive terminal of the cable to the positive terminal of the power source or battery. Isolate the negative cable clamp.)
5. Connect the external power cable into the external power receptacle. Turn the auxiliary power source ON. (If a battery is used as the power source, connect the negative cable clamp to the negative terminal of the power source or to a suitable ground point.)
6. On 14-volt airplanes only, the battery switch must be ON to connect the auxiliary power source to the airplane bus.

Observe the following precautions when disconnecting an external power source:

1. Turn the auxiliary power source OFF. (If a battery has been used for a power source, disconnect the negative clamp of the external power cable and isolate it.)
2. Remove the external power cable from the airplane receptacle. Replace the protective cover in the external power receptacle.
3. Disconnect the external power cable from the auxiliary power source.

SERVICING

FUEL SYSTEM

FUEL TANKS

See **CONSUMABLE MATERIALS** for recommended fuel grades. The fuel system has a total capacity of 103 gallons. The fuel filler caps, one in each wing, are located outboard of each nacelle. Refer to the **LIMITATIONS** section for usable fuel.

CAUTION

Connect a grounding cable from the fuel service unit to the airframe, and connect grounding cables from both the fuel service unit and the airplane to ground during fueling operations. This procedure reduces fire hazard.

To prevent damage to the fuel tanks, do not insert the fuel nozzle more than three inches into the filler neck. Secure the filler caps immediately after filling.

FUEL DRAINS

The fuel system is equipped with a total of 8 drains, 4 drains per wing. A drain valve is located outboard of each nacelle on the underside of each wing tank. A drain is also provided for the selector valve, located in the outboard underside of each nacelle, behind the firewall. Two drains are located inboard of each main gear wheel well for draining crossfeed fuel lines.

The fuel selector valve drains are actuated by a manual "up" movement of .1 to .25 inch. All other fuel drains are flush valves and are opened by using the combination fuel drain/landing gear emergency extension tool.

Open each of the eight fuel drains daily to allow condensed moisture to drain from the system.

FUEL STRAINERS

To preclude the possibility of contaminated fuel, always cap any disconnected fuel lines or fittings. Most fuel system malfunctions can be attributed to contaminated fuel. Inspecting and cleaning the fuel strainers should be considered to be of the utmost importance as a regular part of preventive maintenance.

Normally, the fuel selector valve strainer should be cleaned and inspected every 100 hours of operation. However, the strainer should be inspected and cleaned at more frequent intervals depending on service conditions, fuel handling equipment, and when operating in localities where there is an excessive amount of sand or dust.

Ordinarily, the fuel strainers in the fuel tank outlets should not require cleaning unless there is a definite indication of solid foreign material in the tanks, or the airplane has been stored for an extended period.

OIL SYSTEM

The engines are equipped with a wet sump, pressure-type oil system. Each engine sump has a capacity of 8 quarts. Ser-

ving the oil system is provided through access doors in the engine cowling.

NOTE

Due to the canted position of the engines, the dipsticks are calibrated for either right or left engines and are not interchangeable.

The oil should be changed every 100 hours and the oil filter should be changed every 50 hours, under normal operating conditions. The engines should be warmed to operating temperature to assure complete draining of the oil. The cowling should be removed from the engines for changing the oil and the oil filter. Check the used oil filter for metal particles. (Refer to the Duchess 76 Maintenance Manual.)

The engine manufacturer recommends the use of ashless dispersant oil after the oil consumption has stabilized, or after the first 50 hours of operation. In order to promote faster ring seating and oil control, a straight mineral type oil conforming to MIL-L-6082 may be used until the oil consumption has stabilized, not to exceed 50 hours of operation. Oil of seasonal viscosity, added to maintain the proper oil level during this period, must comply with MIL-L-6082. After the oil consumption has stabilized or after the first 50 hours of operation, aviation grade ashless dispersant oil complying with MIL-L-22851 should be used.

RECOMMENDED OIL GRADES FOR ENGINES

| AVERAGE AMBIENT AIR TEMPERATURE | MIL-L-6082 Grades | MIL-L-22851 Ashless Dispersant Grades |
|--|------------------------------|--|
| Above 60° F | SAE 50 | SAE 40 or SAE 50 |
| 30° F to 90° F | SAE 40 | SAE 40 |
| 0° F to 70° F | SAE 30 | SAE 40, SAE 30 or SAE 20W40 |
| Below 10° F | SAE 20 | SAE 30 or SAE 20W30 |

Refer to Avco Lycoming Service Instruction 1014J or later revision for additional information.

BATTERY

Access to the lead acid battery or batteries is obtained by removing the rear baggage compartment panel and the battery box lid, located aft of the panel. Check the electrolyte level after each 25 hours of operation and add only distilled water as required.

NOTE

Do not fill the battery or batteries over one-half inch above the separators. Only lead-acid equipment should be used when servicing lead-acid type batteries. Use electrolyte of 1.285 Specific Gravity Only.

A systematic battery maintenance program should be established and carefully followed and a log maintained of services performed. The battery must be kept clean and dry for peak performance. If foreign materials are present in sufficient quantities, the resultant deposits may form conductive paths that permit a rapid discharge of the battery. The battery should be serviced and cleaned after each 100 hours of service or 30 days, whichever occurs first, as outlined in the Duchess 76 Maintenance Manual. Clean, tight connections should be maintained at all times.

Battery vents should be checked periodically for obstructions and for proper protrusion (one to three inches) from the skin line. Since either vent may serve as the intake, one vent chamfer should face forward, the other aft (*ME-1 thru ME-182*). Airplanes *ME-183 and after* have no protruding tubes. These vents are designed to produce a venturi effect.

TIRES

The main wheel tires are 6.00x6, 6-ply rating, type III tube type. The nose wheel tire is a 5.00x5, 6-ply rating, type III tube type.

Inflate the tires to 38 psi. When installing a new nose wheel tire, ensure that there is .15 to .25 inch clearance between the fork and the inflated new tire. Maintaining the recommended tire inflation will help to avoid damage from landing shock and contact with sharp stones and ruts, and will minimize tread wear. When inflating tires, inspect them visually for cracks, breaks, wear, or evidence of internal damage.

CAUTION

Beech Aircraft Corporation cannot recommend the use of recapped tires. Recapped tires have a tendency to swell as a result of the increased temperature generated during takeoff. Increased tire size can jeopardize proper function of the landing gear retract system, with the possibility of damage to the landing gear doors and retract mechanism.

SHOCK STRUTS

The shock struts are filled with compressed air and MIL-H-5606 hydraulic fluid. The same procedure is used for servicing both the main and nose shock struts. The shock strut may be served as follows:

1. Remove the air valve cap and depress the valve core to release the air pressure.

WARNING

Do not unscrew the air valve assembly until the air pressure has been released. Otherwise, it may be blown off with considerable force, causing injury to personnel or property damage.

2. Remove the air valve assembly.
3. With the strut in the vertical position and approximately one-fourth inch from fully compressed, fill with MIL-H-5606 hydraulic fluid until the fluid overflows.

4. Cycle the strut (full extension to compressed) and refill as described in step "3". Repeat until fluid cannot be added to the strut in the compressed position.

NOTE

Cycling of the shock strut is necessary to expel any trapped air within the strut housing.

5. Install the air valve assembly.
6. With the airplane on jacks, inflate the nose gear strut with dry air or nitrogen to 250 psi and the main gear strut to 300 psi; or, with the airplane resting on the ground and the fuel tanks full, inflate the nose gear strut until four and one-fourth inches of the piston is exposed, and main gear strut until two inches of the piston is exposed. Rock the airplane gently to prevent possible binding of the piston in the barrel while inflating with the airplane on the ground.

NOTE

The preferred method of inflation is with the airplane on jacks and set the pressure rather than trying to set the strut extension. It is recommended that the nose strut inflation dimension and the tire inflation pressure be carefully adhered to. Properly inflated tires and struts reduce the possibility of ground damage occurring to the propellers. Exercise caution when taxiing over rough surfaces.

7. The shock strut piston must be clean. Remove foreign material by wiping the strut with a cloth dampened in hydraulic fluid.

WARNING

NEVER FILL SHOCK STRUTS WITH OXYGEN.

BRAKES

Brake system servicing is limited primarily to maintaining the hydraulic fluid level in the reservoir. The brake fluid reservoir is located on the left forward side of the forward cabin bulkhead, and is accessible through the small access door on the large access door on the left side of the nose compartment. Fill the reservoir with the MIL-H-5606 hydraulic fluid to the FULL mark on the dipstick. Maintain the fluid level between the FULL and ADD marks. Do not overfill.

The brake disc should be replaced when its thickness measures 0.450 inch.

INDUCTION AIR FILTERS

The induction air filters should be removed, cleaned, and inspected each 50 hours of service. Replacement is recommended at 300 hours for normal operation, and more frequently should conditions warrant. The filter should be cleaned in accordance with the instructions printed on the filter.

1. Remove the upper engine cowling to gain access to the induction air filter, located at the rear of each engine.

2. Remove the screws which secure the filter to the inlet and outlet ducts.
3. Remove the filter from the airplane.

NOTE

When reinstalling the induction air filter, observe the direction of the air flow as marked on the filter.

4. Position the filter and install the screws to secure the filter to the inlet and outlet ducts.
5. Install the upper engine cowling.

INSTRUMENT AIR FILTER

A central filter for the instrument air system is a disposable unit and must be discarded and replaced at 300 to 500 hour intervals, or more often if conditions warrant.

1. Remove the nose compartment access panel and access plates on the nose compartment floor to gain access to the filter located below the floor on the left side, forward of the cabin bulkhead.
2. Remove the clamps at the inlet and outlet of the filter.
3. Remove the filter from the airplane.
4. Position the new filter (note direction of air flow), install the inlet and outlet hoses, and secure in place with clamps at the inlet and outlet of the filter.
5. Install access plates on the nose compartment floor and nose compartment access panel.

PROPELLERS

Propeller Owners Manual and Log Book, and Overhaul Instructions are furnished with the airplane. Maintenance instructions are provided in the Duchess 76 Maintenance Manual.

WARNING

When servicing a propeller, always make certain the MAGNETO/START switches are OFF and the engines have cooled completely. STAND IN THE CLEAR WHEN MOVING A PROPELLER. THERE IS ALWAYS SOME DANGER OF A CYLINDER FIRING WHEN A PROPELLER IS MOVED.

PROPELLER DOME AIR PRESSURE SETTING

1. Remove the propeller spinner dome cap retaining screws and remove the propeller spinner dome cap.
2. Service the propeller air dome cylinder with dry air or nitrogen to a correct pressure as follows:

70° F to 100° F — 41 ± 1 psi

40° F to 70° F — 38 ± 1 psi

0° F to 40° F — 36 ± 1 psi

-30° F to 0° F — 33 ± 1 psi

3. Position the propeller spinner dome cap and secure with the retaining screws.

PROPELLER BLADE BEARING LUBRICATION

1. Remove the spinner dome cap retaining screws and remove the spinner dome cap.
2. Remove the spinner dome retaining screws and remove the spinner dome.
3. Remove the safety wire and covers from the grease fittings.
4. Remove one grease fitting from each blade.
5. Lubricate the blade bearings with MIL-G-23827 grease by placing the grease gun fitting on the remaining fittings on each blade. Fill until the grease is visible in the hole where the opposite fitting was removed.
6. Clean the excess grease from the propeller, reinstall the grease fittings, covers, and safety wire on each blade.
7. Position the spinner dome and install the retaining screws.
8. Position the spinner dome cap and install the retaining screws.

WARNING

The propellers are not interchangeable between left and right engines.

MINOR MAINTENANCE

CABIN HEATER

The heater fuel pump is located on the right side of the nose compartment below the heater, and is accessible through the right side nose compartment access panel.

The manual reset limit (overheat) switch, located on the heater, shuts off the system until reset in case the discharge temperature reaches 300° F.

CAUTION

The entire system should be inspected and the malfunction determined and corrected before re-setting the overheat switch.

Every 500 hours of heater operation, the heater should be removed from the airplane and disassembled. All parts should be thoroughly inspected, necessary repairs made and parts replaced. (Refer to the Duchess 76 Maintenance Manual.)

ALTERNATORS

Since the alternators and electronic voltage regulators are designed for use on only one polarity system, the following precautionary measures must be observed when working on the charging circuit or serious damage to the electrical equipment will result:

1. When installing a battery, make certain that the ground polarity of the battery and the ground polarity of the alternator are the same.
2. When connecting a booster battery, be sure to connect the negative battery terminals together and the positive battery terminals together.
3. When using a battery charger, connect the positive lead of the charger to the positive battery terminal and the negative lead of the charger to the negative battery terminal.
4. Do not operate an alternator on open circuit. Be sure all circuit connections are secure.
5. Do not short across or ground any of the terminals on the alternator or electronic voltage regulator.
6. Do not attempt to polarize an alternator.

MAGNETOS

CAUTION

Before installing a new magneto, it is vitally important to check the identification plate for the proper part number to ensure the correct magneto is installed on the proper engine. The magnetos are not interchangeable between left and right engines.

The magneto ignition system should be checked after the first 50 hours of operation and every 100 hours thereafter. Contact point clearance for the magneto right main breaker is $.016 \pm .004$, left main breaker is $.016 \pm .002$. Points with deep pits or with excessively burned areas should be discarded. Inspect the cam follower felt pad for proper lubrication and clean the breaker compartment with a clean dry cloth.

WARNING

To be safe, treat all magnetos as hot whenever the ground lead is disconnected. To ground the magneto, disconnect the ignition switch lead wire at the capacitor and ground the capacitor pole. If this is impractical, remove the ignition harness on the magneto or disconnect the spark plug leads.

CLEANING

EXTERIOR PAINTED SURFACES

NOTE

Acrylic urethane paint finishes are fully cured at the time of delivery.

Because wax seals the paint from the outside air, a new acrylic urethane or lacquer paint job should not be waxed for a period of 90 days to allow the paint to cure. Wash uncured painted surfaces with only cold or lukewarm (never hot) water and a mild non-detergent soap. Any rubbing of the painted surface should be done gently and held to a minimum.

CAUTION

When washing the airplane with mild soap and water, use special care to avoid washing away grease from any lubricated area. After washing with solvent in the wheel well areas, lubricate all lubrication points. Premature wear of lubricated surfaces may result if the above precautions are not taken.

Prior to cleaning, cover the wheels, making certain the brake discs are covered. Attach the pitot cover securely, and plug or mask off all other openings. Be particularly careful to mask off all static air buttons before washing or waxing.

After the paint cures, a thorough waxing will protect painted and unpainted metal surfaces from a variety of highly corrosive elements. Flush loose dirt away first with clear water, then wash the airplane with a mild soap and water. Harsh, abrasive, or alkaline soaps or detergents should never be used. Use a soft cleaning cloth or chamois to prevent scratches when cleaning. Any good grade of non-abrasive and non-silicone wax may be used to preserve painted surfaces. To remove stubborn oil and grease, use a soft cloth dampened with aliphatic naphtha. After cleaning with naphtha, the surface should be rewaxed.

WINDSHIELD AND WINDOWS

CAUTION

Do not scratch windows when cleaning. Do not use an ice scraper to remove ice from windows.

A commercial cleaning compound made specifically for acrylic plastic windows may be used. When using a commercial cleaner, follow the instructions on the container.

If a commercial cleaner is not available, the following instructions should be followed:

Cleaning of the acrylic plastic windows should never be attempted when dry. Use only clean water (an open bucket of water can collect sand/debris which could scratch windshields) and a mild soap for cleaning. Wash the windows with plenty of soap and water, using the palm of the hand to dislodge dirt and mud. Follow up with soapy water to remove grease or stains. Flush the surface with rinse water and rub

slightly with a grit-free soft cloth, chamois or sponge. Stubborn grease or oil deposits are readily removed with aliphatic naphtha or hexane. Rinse with clear water.

CAUTION

Do not use thinner or aromatic abrasive cleaners to clean the windows as they will damage the surface of the plastic. Aliphatic naphtha and similar solvents are highly inflammable, and extreme care must be exercised when used.

ENGINE

Clean the engine with kerosene, solvent, or any standard engine cleaning fluid. Spray or brush the fluid over the engine, then wash off with water and allow to dry.

INTERIOR

The seats, rugs, upholstery panels, and headliner should be vacuum-cleaned frequently. Do not use water to clean fabric surfaces. Commercial foam-type cleaners or shampoos can be used to clean carpets, fabrics, and upholstery; however, the instructions on the container should be followed carefully.

Proper care and cleaning of the interior cabin trim (Noryl and Kydex plastics) is of primary importance to maintain a desirable appearance. Washing the interior cabin trim with a detergent soap and water, and brush scrubbing with a soft bristle brush, will dislodge most dirt. Rinse with clean water and

wipe dry. Alcohol may be used to remove foreign material that is alcohol soluble.

CAUTION

The interior cabin trim can be easily damaged if cleaned with methyl ethyl ketone, naphtha, Multi standard solvent, gasoline, lacquer thinner and other types of thinners. Sharp edges or cuts on the edge of the interior cabin trim material may cause it to crack.

76-604-10

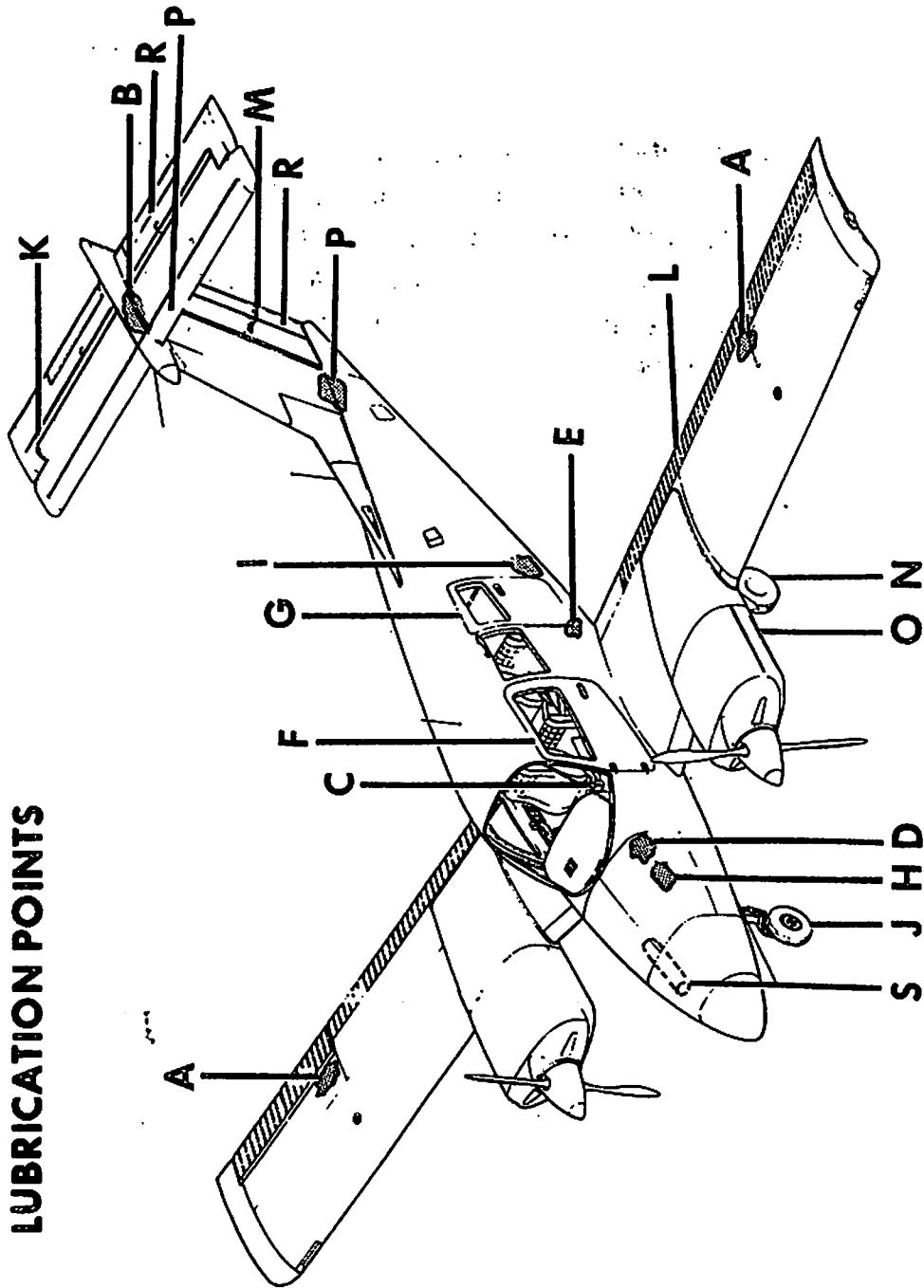

LUBRICATION POINTS

A

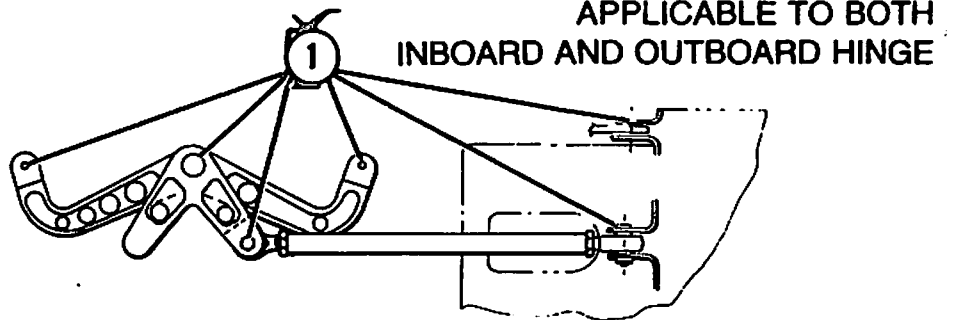

AILERON BELL CRANK AND PUSHROD

B

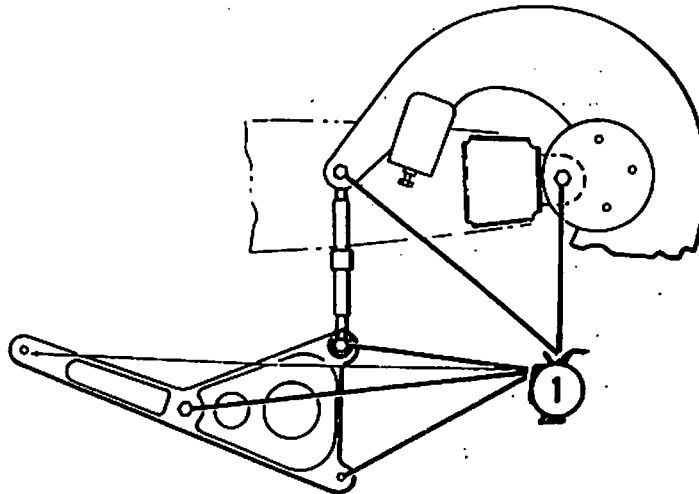

ELEVATOR BELL CRANK, PUSHROD AND HORN

C

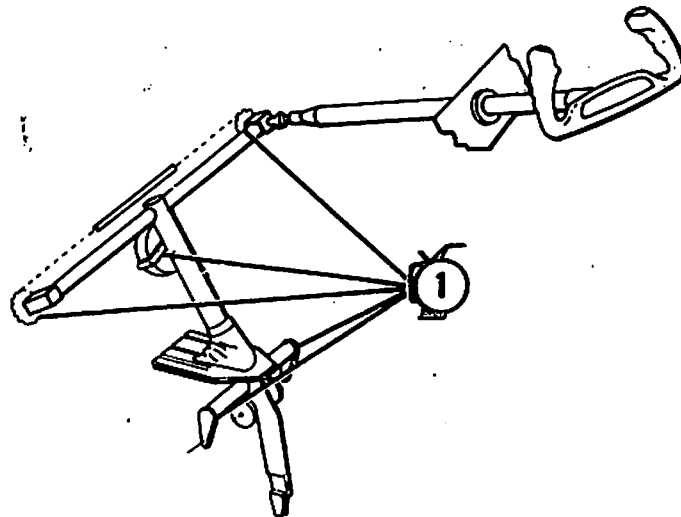

CONTROL COLUMN

76-604-11

D

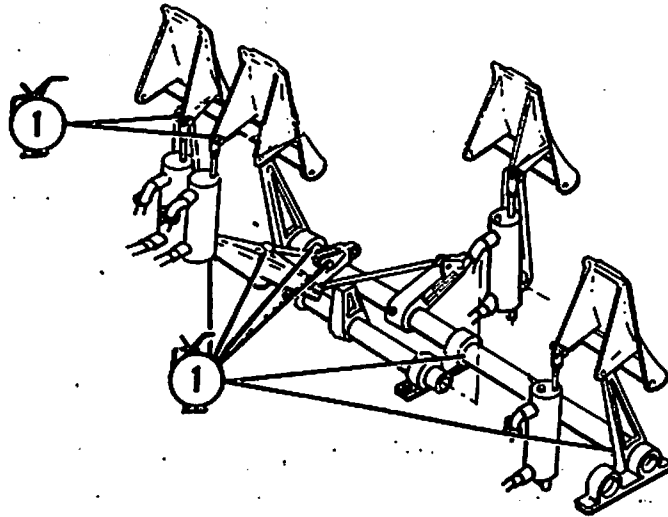

**RUDDER PEDAL ASSEMBLY AND
BRAKE MASTER CYLINDERS**

E

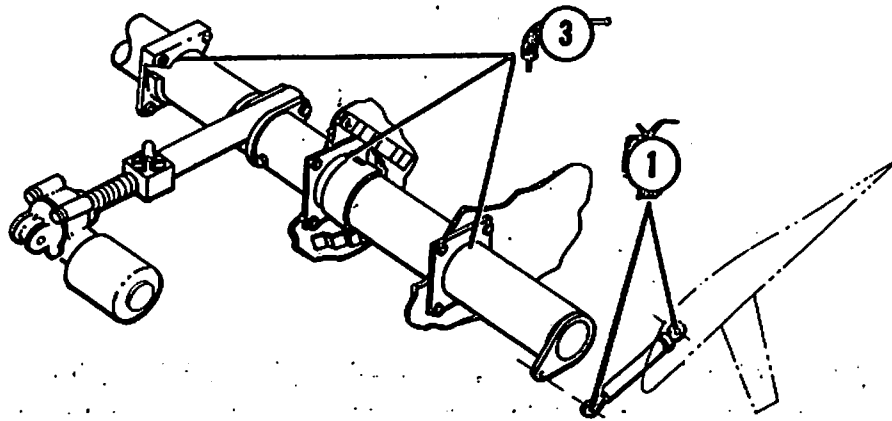

ELECTRIC FLAP ACTUATOR ASSEMBLY

F

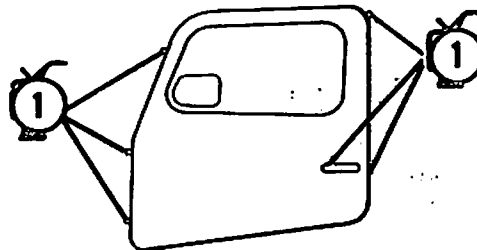

CABIN DOOR

76-604-12

G

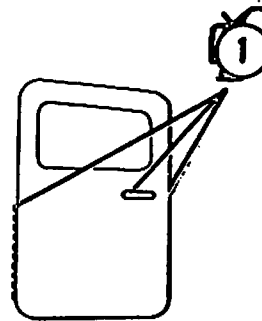

BAGGAGE DOOR

H

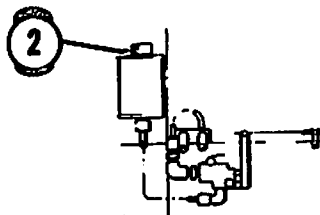

BRAKE RESERVOIR AND PARKING BRAKE VALVE

I

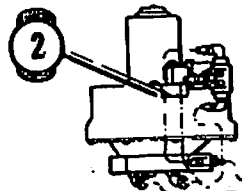

LANDING GEAR HYDRAULIC PUMP AND RESERVOIR

76-604-13

J

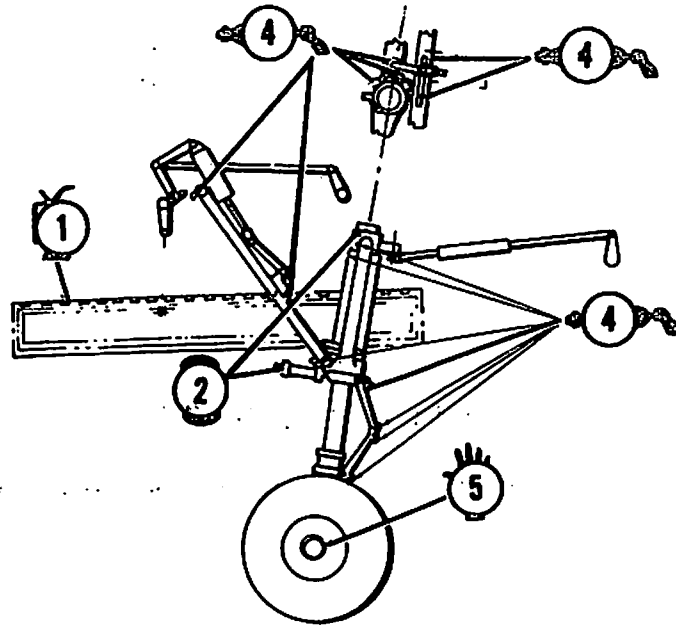

NOSE GEAR INSTALLATION AND DOORS

K

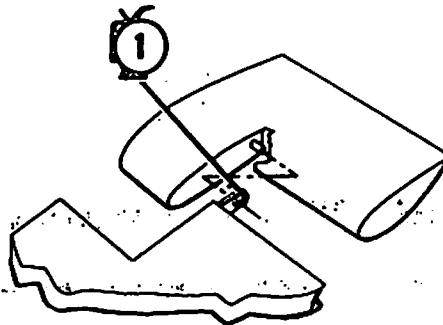

ELEVATOR STABILIZER HINGE

L

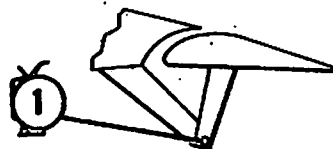

FLAP INSTALLATION

76-604-14

M

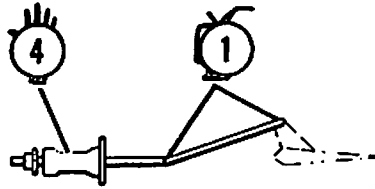

RUDDER AND ELEVATOR TAB ACTUATOR

N

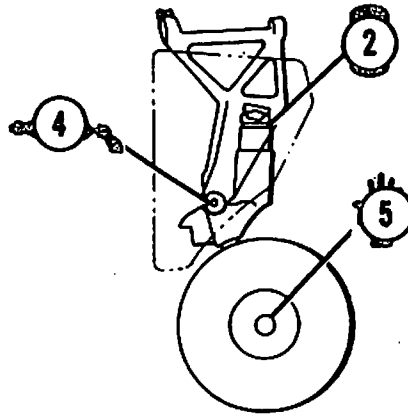

MAIN LANDING GEAR

O

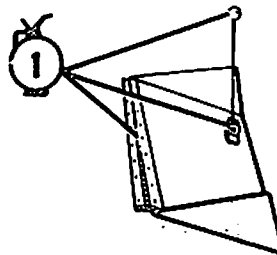

COWL FLAP

76-604-15

P

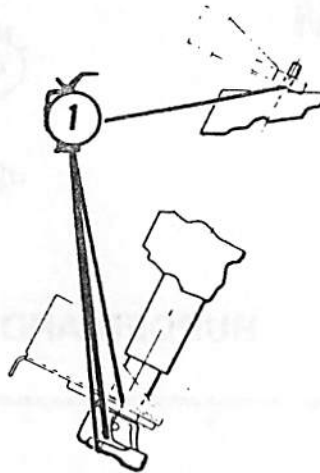

UPPER AND LOWER RUDDER INSTALLATION

R
I

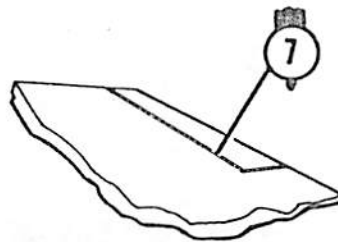

ELEVATOR AND RUDDER TAB HINGE

S

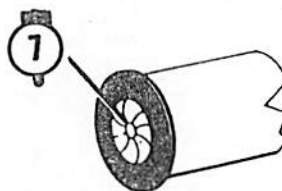

HEATER

76-604-16



ZERK FITTING



FLUID CONTAINER



SQUIRT CAN



HAND OR PACK



SPRAY



BRUSH

76-604-17

Letters are keyed to the Recommended Servicing Schedule. Numbers refer to items in Consumable Materials chart. Symbols, as shown above, indicate the method of lubrication.

Lubricate all plain bearing bushings, all push-pull control housings and all flight control pulley bushings, as required, or every 500 hours with SAE 10W30 oil.

Exercise care when using MIL-G-23827 greases as they contain a rust preventative which will discolor painted surfaces.

RECOMMENDED SERVICING SCHEDULE

| INTER-VAL | ITEM | LOCATION (Letters refer to Lubri- cation Points Diagram) | MATERIALS (Numbers refer to Items in Consumable Materials) |
|-----------|--|--|--|
| 25 Hrs | Check Battery Electrolyte Level | Aft of aft cabin bulkhead | Distilled water only |
| | Lube Nose Landing Gear Linkage (13 places) | Nose landing gear (J) | (4) |
| | Lube Lower Fork Attach Point (2 places) | Main landing gear (N) | (4) |
| 50 Hrs | Change Engine Oil Filters | Remove engine cowl | Refer to Maintenance Manual |
| | Clean Engine Induction Air Filters | Remove upper engine cowling | Clean per instructions on filter |

January 1978

8-39

| | | | |
|---------|--|---|---|
| 100 Hrs | Change Engine Oil | Remove engine cowl | (8) Refer to Maintenance Manual |
| | Clean Fuel Selector Valve Fuel Strainers | Remove the access cover on the bottom of each nacelle (O) | Clean with clean solvent (10) |
| | Clean, Test and Regap Spark Plugs | Remove engine cowl, both sides of each engine | — |
| | Check Magneto Timing | Remove engine cowl | Refer to Maintenance Manual |
| | Check Emergency Locator Transmitter | Right side of aft fuselage | Tune radio to 121.5 MHz on VHF or 243 MHz on UHF, then turn ELT switch to ON and monitor for one signal. Turn ELT switch OFF, then place in ARM position. |
| | Lube Aileron Bell Crank and Push Rod Linkage (12 places) | Left and right ailerons (A) | (1) |

BEECHCRAFT
Duchess 76

Section VIII
Handling, Serv and Maint

8-40

January 1978

| INTER-VAL | ITEM | LOCATION (Letters refer to Lubri- cation Points Diagram) | MATERIALS (Numbers refer to Items in Consumable Materials) |
|---------------------|---|--|--|
| 100 Hrs (Cont'd) | Lube Elevator Bell Crank Link- age (6 places) | Elevator (B) | (1) |
| | Lube Electric Flap Actuator Torque Shaft (3 places) | Under aft cabin floorboards under rear passenger seats (E) | (3) |
| | Lube Electric Flap Actuator Rod Assembly (4 places) | Flap (E) | (1) |
| | Lube Cabin Door Hinges and Latch Mechanisms (12 places) | Left and right cabin doors (F) | (1) |
| | Lube Baggage Door Hinge and Latch Mechanisms (3 places) | Baggage door (G) | (1) |

Section VIII
Handling, Serv and MaintBEECHCRAFT
Duchess 76

January 1978

8-41

| | | | |
|---------------------|---|-----------------------------|-----|
| 100 Hrs (Cont'd) | Lube Nose Landing Gear Door Hinges | Nose landing gear doors (J) | (1) |
| | Lube Nose Landing Gear Wheel Bearing | Nose landing gear (J) | (5) |
| | Lube Elevator Stabilizer Hinge (2 places) | Elevator (K) | (1) |
| | Lube Flap Installation Hinge (6 places) | Flap (L) | (1) |
| | Lube Rudder and Elevator Tab Actuator Rod Hinges (2 places) | Empennage (M) | (1) |
| | Lube Main Landing Gear Wheel Bearings | Main landing gear (N) | (5) |
| | Lube Cowl Flap Hinge and Attach Points (4 places) | Left and right nacelles (O) | (1) |

BEECHCRAFT
Duchess 76

Section VIII
Handling, Serv and Maint

| INTER-VAL | ITEM | LOCATION (Letters refer to Lubri- cation Points Diagram) | MATERIALS (Numbers refer to Items in Consumable Materials) |
|---------------------|--|--|--|
| 100 Hrs (Cont'd) | Lube Upper and Lower Rudder Installation Attach Points (4 places) | Rudder (P) | (1) |
| | Lube Elevator Tab and Rudder Tab Hinges | Elevator tab and rudder tab (R) | (7) |
| | Clean Static Air Buttons | Aft fuselage | Clean with solvent (10) and wipe dry with a clean rag |
| | Drain Static Air Lines | Flight compartment left side panel, forward of door frame | — |
| | Check Scupper Drains - Drain Guards Open, Facing Aft and Drain Holes are Free from Ob- structions | Rear fuselage and empen- nage | — |

January 1978

8-43

| | | | |
|----------------|--|--|---------------------------------|
| 300 Hrs | Replace Induction Air Filters | Remove upper engine cowling | Refer to Maintenance Manual |
| 300 to 500 Hrs | Replace Instrument Air Filter | Under nose compartment floor, left side | Refer to Maintenance Manual |
| 500 Hrs | Lube Rudder Pedals and Linkage (18 places) | Flight Compartment (D) | (1) |
| 1000 Hrs | Lube Control Column Linkage (5 places) | Forward of instrument panel (C) | (1) |
| 1200 Hrs | Lube Rudder Tab and Elevator Tab Actuator | Empennage | (4) Refer to Maintenance Manual |
| As Req. | Lube Magneto Cam Follower Felt (2 places) | Remove engine cowl | (9) |
| | Service Brake Reservoir | Through small access door on large access door - left side of nose compartment (H) | (2) |

BEECHCRAFT
Duchess 76

Section VIII
Handling, Serv and Maint

| INTER-VAL | ITEM | LOCATION (Letters refer to Lubri- cation Points Diagram) | MATERIALS (Numbers refer to Items in Consumable Materials) |
|---------------------|---|--|--|
| As Req. (Cont'd) | Service Hydraulic Pump Re- servoir | Aft of aft cabin bulkhead (I) | (2) |
| | Service Nose Landing Gear Shock Strut and Shimmy Dampener | Nose landing gear (J) | (2) Refer to Maintenance Manual |
| | Service Main Landing Gear Shock Struts | Main landing gear (N) | (2) Refer to Maintenance Manual |
| | Lube Heater Iris Valve | Through access door, right lower nose compartment (S) | (7) |
| †† | Check Emergency Locator Transmitter Battery | Right side of aft fuselage | - |

January 1978

- NOTES:**
- 1. Any time the control surfaces are repainted, or repaired, they must be rebalanced per Maintenance Manual.**
 - 2. Check the wing bolts for proper torque at the first 100-hour inspection and at the first 100-hour inspection after each reinstallation of the wing attach bolts.**

†† Rechargeable Batteries: Recharge after one cumulative hour of use or after 50% of the useful charge life.
Non-Rechargeable Batteries: Replace after one cumulative hour or after 50% of the useful life.

CONSUMABLE MATERIALS

Only the basic number of each Military Specification is included in the Consumable Materials Chart. No attempt has been made to update the basic number with the letter suffix that designates the current issues of the various specifications.

Vendors listed as meeting Federal and Military Specifications are provided as reference only and are not specifically recommended by Beech Aircraft Corporation; consequently, any product conforming to the specification listed may be used. The products listed below have been tested and approved for aviation usage by Beech Aircraft Corporation, by the vendor, or by compliance with the applicable specifications. Other products that are locally procurable which conform to the requirements of the applicable Military Specification may be used even though not specifically included herein.

It is the responsibility of the operator/user to determine the current revision of the applicable Military Specification prior to usage of that item. This determination may be made by contacting the vendor of a specific item.

| ITEM | MATERIAL | SPECIFICATION |
|------|--|--|
| 1. | Lubricating Oil | SAE 10W30 |
| 2. | Hydraulic Fluid | MIL-H-5606 |
| 3. | Lubricant Krylon Heavy Duty | Silicon Spray No. 1325, No. 1329 or Equivalent |
| 4. | Lubricating Grease (Aircraft & Instrument, High and Low Temperature) | MIL-G-23827 |
| *5. | Grease (Hi-Temp) | MIL-G-81322 |
| 6. | Item deleted | |

**BEECHCRAFT
Duchess 76**

**Section VIII
Handling, Serv and Maint**

| | |
|--------------------------------------|---|
| ****7. Molybdenum Disulfide | MIL-M-7866 |
| **8. Engine Oil | MIL-L-22851 |
| 9. Lubricant, Felt | 10-86527 |
| 10. Solvent | Federal Specification PD 680 |
| 11. Engine Fuel | 100 (Green) or 100 LL (Blue) Minimum Grade Fuel |
| 12. Corrosion Preventive Compound | MIL-C-6529 (Anti-Corrode No. 205) |
| ***13. Engine Fuel Additive | ALCOR TCP Concentrate |

* In extremely cold climates use MIL-G-23827 grease in place of MIL-G-81322. (These greases are harmful to paint.)

** Ashless dispersant oil complying with MIL-L-22851 is recommended after the oil consumption has stabilized or after the first 50 hours of operation. A straight mineral oil conforming to MIL-L-6082 may be used until the oil consumption has stabilized, not to exceed 50 hours of operation. Oil of seasonal viscosity, added to maintain the proper oil level during this break-in period, must comply with MIL-L-6082.

*** Product of Alcor, Inc., San Antonio, Texas 78284

**** For use on elevator and rudder tab hinge mix with naphtha into a paste and apply with a brush.

APPROVED ENGINE OILS

| COMPANY | BRAND NAME |
|---------------------------------------|--|
| Delta Petroleum Co., Inc. | *Global Concentrate A |
| Enjay Chemical Company | *Paranox 160 and 165 |
| Mobil Oil Corporation | *RT-451, RM-173E, RM-180E |
| Shell Oil Company | *Shell Concentrate A - Code 60068 *Aeroshell W120 *Aeroshell W80 |
| Texaco Incorporated | *TX-6309 *Aircraft Engine Oil Premium AD120 *Aircraft Engine Oil Premium AD80 |
| American Oil and Sup- ply Co. | *PQ Aviation Lubricant 753 |
| Chevron Oil Company | *Chevron Aero Oil Grade 120 |
| Humble Oil and Refin- ing Co. | *Esso Aviation Oil E-120 *Enco Aviation Oil E-120 *Esso Aviation Oil A-100 *Enco Aviation Oil A-100 *Esso Aviation Oil E-80 *Enco Aviation Oil E-80 |
| Standard Oil Company of California | *Chevron Aero Oil Grade 120 |

**BEECHCRAFT
Duchess 76**

**Section VIII
Handling, Serv and Maint**

Castrol Oils, Canada Ltd. **Castrolaero 113, Grade 1065
 **Castrolaero 117, Grade 1100

Champlin Oil and Refining Co. **Grade 1065
 **Grade 1100

Chevron Oil Company **Chevron Aviation Oil 65
 **Grade 1100

Continental Oil Company **Conoco Aero Oil 1065
 **Conoco Aero Oil 1100

Mobil Oil Corporation **Avrex 101/1065
 ** 101/1100

Phillips Petroleum Co. **Phillips 66 Aviation Engine Oil,
 Grade 1065
 **Phillips 66 Aviation Engine Oil,
 Grade 1100

Shell Oil Company **Aeroshell Oil 65
 **Aeroshell Oil 100

* Ashless Dispersant Oils Complying with MIL-L-22851

NOTE

Ashless dispersant oil complying with MIL-L-22851 is recommended after the oil consumption has stabilized or after the first 50 hours of operation.

**** Straight Mineral Oils Complying with MIL-L-6082**

NOTE

A straight mineral oil conforming to MIL-L-6082 may be used until the oil consumption has stabilized, not to exceed 50 hours of operation. Oil of seasonal viscosity, added to maintain the proper oil level during this break-in period, must comply with MIL-L-6082.

Vendors listed as meeting Federal and Military Specifications are provided as reference only and are not specifically recommended by Beech Aircraft Corporation. Any product conforming to the specification may be used.

LAMP BULB REPLACEMENT GUIDE

LOCATION

NUMBER

*14 VOLT

**28 VOLT

| | | |
|-------------------------------------|--------------------------|--------------------------|
| Post Lights | 330 | 327 |
| Compass Light | 330 | 327 |
| Cabin Dome Light | 89 | 303 |
| Taxi Lights | 4595 | 4594 |
| Landing Light | 4313 | 4596 |
| Tail Light | 1777 | 1683 |
| Landing Gear In-transit Lights | 330 | 327 |
| Overhead Instrument Panel Lights | 89 | 303 |
| Engine Instrument Cluster Light | 266 | 267 |
| Wing Tip Lights | A7512-12 | A7512-24 |
| Strobe Light, Wing | 55-0221-3 (Flashtube) | 55-0221-3 (Flashtube) |
| Engine Instrument Post Lights | 330 | 327 |
| Landing Gear Down and Locked Lights | 330 | 327 |

*14-VOLT: ME-1 thru ME-182

**28-VOLT: ME-183 and after

April 1979

8-51

BEECHCRAFT
Duchess 76

Section VIII
Handling, Serv and Maint

OVERHAUL AND REPLACEMENT GUIDE

The first overhaul or replacement should be performed not later than the required period. The condition of the item at the end of the first period can be used as a criterion for determining subsequent periods applicable to the individual airplane or fleet operation, providing the operator has an approved monitoring system.

The time periods for inspections noted in this handbook are based on average usage and average environmental conditions.

SPECIAL CONDITIONS CAUTIONARY NOTICE

Airplanes operated for Air Taxi or other than normal operation, and airplanes operated in humid tropics or cold and damp climates, etc., may need more frequent inspections for wear, corrosion and/or lack of lubrication. In these areas, periodic inspections should be performed until the operator can set his own inspection periods based on experience.

NOTE

The required periods do not constitute a guarantee that the item will reach the period without malfunction as the aforementioned factors cannot be controlled by the manufacturer.

NOTE

On-condition items are to be overhauled or replaced when inspection or performance of these items reveal a potentially unsafe or unserviceable condition.

COMPONENT OVERHAUL OR REPLACE

POWER PLANT

NOTE

A TBO (time between overhaul) recommendation is in no way to be construed as a warranty or engine life proration basis. The TBO recommendation is based on the projected time for most advantageous initial overhaul. The individual operator's experience may indicate a departure in either direction from the recommended TBO for the particular operation.

NOTE

When an engine has been overhauled, or a new engine installed, it is recommended that low power settings NOT be used until oil consumption has stabilized. The average time for piston ring seating is approximately 50 hours. Refer to Lycoming Engine Operator's Manual.

| | |
|-------------------------------|--|
| Engines | Refer to latest edition Avco-Lycoming SI 1009 |
| Propellers | Refer to latest edition Hartzell Bulletin 61 |
| Magnetos | At engine overhaul |
| Dry air pressure pumps | Every 1400 hours or on condition |
| All hoses | Hoses carrying flammable liquids; at engine overhaul or every 5 years, whichever occurs first. |

OVERHAUL AND REPLACEMENT GUIDE (Cont'd)

COMPONENT OVERHAUL OR REPLACE

FUEL SYSTEM

| | |
|------------------|--|
| All hoses | Hoses carrying flammable liquids; at engine overhaul or every 5 years whichever occurs first. |
|------------------|--|

ELECTRICAL SYSTEM

| | |
|--|---|
| Starter | At engine overhaul |
| Alternator | At engine overhaul |
| Battery (Emergency Locator Transmitter) | Per applicable regulations, or by date stamped on battery, whichever occurs first. |

UTILITY SYSTEM

| | |
|---------------------|--|
| Cabin heater | Refer to latest edition Janitrol Maintenance & Overhaul Manual 11D74 and applicable Airworthiness Directives. |
|---------------------|--|

WING STRUCTURE INSPECTION SCHEDULE

The basic wing structure has a substantiated life of 20,000 flight hours provided the mandatory inspection requirements of chapter four of the BEECHCRAFT DUCHESS 76 MAINTENANCE MANUAL are complied with.

NOTE

Anytime the control surfaces are repaired or repainted, they must be rebalanced as described in the Maintenance Manual.

SUPPLEMENTS

SECTION IX SUPPLEMENTS

NOTE

The supplemental data contained in this section is for equipment that was delivered on the airplane including standard optional equipment that was available, whether it was installed or not. Airplane Flight Manual Supplements for equipment for which the vendor obtained a Supplemental Type Certificate were included as loose equipment with the airplane at the time of delivery. These and other Airplane Flight Manual Supplements for other equipment that was installed after the airplane was delivered new from the factory should be placed in this Supplemental Data Section IX, of this Pilot's Operating Handbook and FAA Approved Airplane Flight Manual.

INTENTIONALLY LEFT BLANK

**PILOT'S OPERATING HANDBOOK
and
FAA APPROVED AIRPLANE FLIGHT MANUAL**

LOG OF SUPPLEMENTS

| <i>FAA Supplements must be in the airplane for flight operation when subject equipment is installed:</i> | | | | |
|--|---------------|--|----------|------|
| Supp. No. | Part Number | Subject | Rev. No. | Date |
| 1 | 105-590000-25 | King KNS-80 Integrated Navigation System | | 1/80 |

BEECHCRAFT DUCHESS 76

LANDPLANE

PILOT'S OPERATING HANDBOOK AND FAA APPROVED AIRPLANE FLIGHT MANUAL SUPPLEMENT for the KING KNS-80 INTEGRATED NAVIGATION SYSTEM

GENERAL

The information in this supplement is FAA-approved material and must be attached to the Pilot's Operating Handbook and FAA Approved Airplane Flight Manual when the airplane has been modified by installation of the King KNS-80 Navigation System in accordance with Beech-approved data.

The information in this supplement supersedes or adds to the basic Pilot's Operating Handbook and FAA Approved Airplane Flight Manual only as set forth within this document. Users of the manual are advised always to refer to the supplement for possibly superseding information and placarding applicable to operation of the airplane.

LIMITATIONS

1. The Area Navigation mode may not be used as a primary system under IFR conditions except on approved approach procedures, approved airways, and random area navigation routes when approved by Air Traffic Control.
2. The Area Navigation mode can only be used with colocated facilities (VOR and DME signals originate from the same geographical location).

**FAA Approved
Issued January, 1980
P/N 105-590000-25**

3. VOR or VOR-PAR modes must be selected when flying directly to or from a VORTAC facility.

EMERGENCY PROCEDURES

CAUTION

DME may unlock due to loss of signal with certain combinations of distance from station, altitude and angle of bank.

1. If NAV flag appears while in the Area Navigation mode, check for correct frequency.
2. If VOR or DME equipment is intermittent or lost, utilize other navigation equipment as required.
3. If NAV flag appears during an approach, execute published missed approach and utilize another approved facility.

NORMAL PROCEDURES

PREFLIGHT

AREA NAVIGATION FUNCTIONAL TEST

The following procedure applies only to airports equipped with, or in range of, a colocated VOR/DME station.

1. Place the KNS-80 in VOR mode.
2. Find and record the angle to the VOR station by centering the D-Bar with a TO indication.

FAA Approved
Issued January, 1980
P/N 105-590000-25

3. Program a waypoint radial angle 120° greater than the indicated VOR radial.
4. Program a waypoint distance equal to the indicated DME value.
5. Place the KNS-80 in RNAV ENR.
6. Rotate the OBS until the D-Bar centers with a TO indication.

The KNS-80 distance-to-station should now read a value equal to the DME distance ($\pm .5\text{NM}$), and the indicated selected course should read 60° greater than the recorded VOR angle to station.

PROGRAMMING

Pertinent information (waypoint number, station frequency, waypoint bearing, and waypoint distance) for up to four waypoints is entered into the memory from the control unit. Programming may be completed prior to takeoff or during the flight. Any combination of navigational facilities (RNAV waypoint, VOR/DME, ILS) may be loaded into the computer; however, it is desirable that each facility be numbered and loaded in the sequence it is to be used.

RNAV WAYPOINTS

1. Turn the system on by rotating the ON/OFF switch clockwise.
2. Put waypoint 1 in the DSP window by depressing the DSP button. Push button as many times as necessary to go through the 1-2-3-4-1 sequence to reach "1".
3. Select the waypoint 1 frequency using the data input controls, which are the two concentric knobs on the right.

4. Select the waypoint 1 radial by depressing the DATA button. This will cause the radial for the previous waypoint 1 to appear over the annunciation RAD. Select the new radial with the data input controls.

5. Select the waypoint 1 distance by again depressing the DATA button. This will cause the distance for the previous waypoint 1 to appear over the annunciation DST. Select the new distance with the data input controls.

6. This completes the programming for the first waypoint. Follow these procedures for all selected waypoints up to a maximum of four.

CONVENTIONAL VOR

The programming technique for conventional navigation directly toward or away from a VOR facility without a collocated DME is similar to that for RNAV waypoints. Inputting the waypoint number and frequency into the memory is accomplished in the same manner. Since the station has no DME, it cannot be electronically "moved" to a new location (waypoint). Therefore, no values are programmed in the RAD or DST displays.

ILS APPROACH (Front course and Back course)

Programming an ILS approach is accomplished in the same manner as programming conventional VOR.

MISSED APPROACH

If the published missed approach utilizes an RNAV waypoint or VOR facility, it may be entered into the memory any time prior to the approach. This is accomplished in the same manner set forth in CONVENTIONAL VOR and RNAV WAYPOINTS in this section.

INFLIGHT

Preset waypoints may be recalled from memory and put into active use as required.

1. Press the DSP button as required to select the desired waypoint. The preset waypoint frequency will replace the active waypoint frequency on the display. The selected waypoint number will appear (blinking) over the DSP annunciation. This blinking display is to indicate that the frequency displayed is other than the active waypoint. The waypoint radial and distance may also be checked at this time by pressing the DSP button for each.
2. Verify that the data is correct.

NOTE

Revisions to the waypoint data can be programmed at this time by entering the new waypoint parameters.

3. When navigation to the displayed waypoint is desired, press the USE button. The waypoint number will appear above the USE annunciation on the display board and the number above the DSP annunciation will cease blinking. The new waypoint frequency will automatically appear.

NOTE

When "Time To Station" indicates "0," actual time may be anything from 0 to 59 seconds.

RNAV OPERATION

If the system is receiving valid signals from a colocated VOR-LOC facility, it will supply linear deviation information to the Horizontal Situation Indicator (or Course Deviation Indicator). Enroute (RNV ENR) sensitivity, available by pressing the RNAV button, provides a constant course width of ± 5 NM. Approach (RNV APR) sensitivity, available by pushing the RNAV button again, provides a constant course width of $\pm 1\frac{1}{4}$ NM. Approach sensitivity should be used when within 10 miles of the terminal waypoint. Time and distance to the waypoint, and computed groundspeed are displayed at the top of the display panel.

CONVENTIONAL VOR OPERATION

VOR or VOR-PAR modes are selected by pressing the VOR button; once for VOR and a second time for VOR-PAR. In VOR mode DME is automatically tuned, and distance, groundspeed and time-to-station to the VORTAC station will be displayed upon lock-on. The HSI (CDI) will display conventional angular crosstrack deviation from the selected course ($\pm 10^\circ$ full scale). In VOR-PAR mode operation is identical to VOR except the HSI (CDI) will display crosstrack deviation of ± 5 NM full scale from the selected course. Course width will be constant irrespective of distance from the VORTAC.

ILS OPERATION

The ILS mode is annunciated whenever an ILS frequency is put "in use". LOC/GS functions are annunciated by the LOC and GS flags in the HSI (CDI). Only angular deviation is provided in the ILS mode.

DME HOLD OPERATION

The DME Hold (HLD) function inhibits changing the DME

FAA Approved
Issued January, 1980
P/N 105-590000-25

receiver frequency. Pressing the HOLD button and then selecting a new waypoint forces the KNS-80 into either a conventional VOR or ILS mode of operation according to the newly selected frequency.

Engage DME HOLD as follows:

1. Press the HOLD button.
2. Select the new frequency using the data input controls. HLD will now annunciate. Distance will continue to be read to the VORTAC and information to the HSI (CDI) will be from the newly selected station.

RNAV APPROACH

The RNAV Approach (RNV-APR) mode may be used for runway location (by placing a waypoint at the approach end of the runway) during an approach to an airport. Press the RNAV button to select RNV-APR. In RNV-APR the deviation needle on the HSI (CDI) will display crosstrack deviation of $\pm 1\frac{1}{4}$ NM full scale. All other aspects of the RNV-APR mode are identical to the RNV-ENR mode.

PERFORMANCE - No change

WEIGHT AND BALANCE - No change

SYSTEMS DESCRIPTION

The King KNS-80 is an integrated navigation system combining a 200 channel VOR/Localizer receiver, a 40 channel glideslope receiver, a 200 channel DME, and a digital RNAV computer with a capability for preselection and

**FAA Approved
Issued January, 1980
P/N 105-590000-25**

storage of 4 VOR/LOC frequencies and RNAV waypoint parameters.

The KNS-80 can be operated in any one of three basic modes: VOR, RNAV, or ILS. To change from one mode to another the appropriate pushbutton switch is pressed, except that the ILS mode is entered automatically whenever an ILS frequency is channeled in the USE waypoint. The display will annunciate the mode by lighting a message above the pushbutton. In addition to the standard VOR and RNAV enroute (RNV ENR) modes, the KNS-80 has a constant course width or parallel VOR mode (VOR-PAR) and an RNAV approach mode (RNV APR). To place the unit in either of these secondary modes, the VOR pushbutton or the RNAV pushbutton, as the case may be, is pushed a second time. Repetitive pushing of the VOR button will cause the system to alternate between the VOR and VOR-PAR modes, while repetitive pushing of the RNAV button causes the system to alternate between RNV ENR and RNV APR modes.

All waypoint information, station frequency, waypoint distance, and waypoint radial are entered with the increment/decrement rotary switch on the right side of the panel and displayed in the right hand readout. The small knob affects the lower significant digits while the large knob changes the most significant digits. The tenth's position of waypoint radial and distance can be changed by pulling the small knob to the out position. The type of data being displayed is indicated by the illuminated messages (FRQ, RAD, DST) located directly below the displayed data. Frequency, radial, or distance information for a waypoint can be displayed sequentially by pressing the "DATA" pushbutton. The increment/decrement switch changes only the information being displayed.

The KNS-80 can store frequency, radial, and distance information for up to four waypoints. The waypoint number

FAA Approved
Issued January, 1980
P/N 105-590000-25

of the data being displayed is located above the message DSP. The DSP waypoint number is changed by pressing the DSP button. The number of the waypoint being used for navigation is indicated by the number above the message USE. If the waypoint in use is different from the displayed waypoint, the DSP waypoint number blinks. Pressing the USE button causes the waypoint in use to match the displayed waypoint.

Normally, the DME is tuned to the station paired with the VOR frequency. The tuning of the DME may be frozen by depressing the HOLD button. Subsequent rechanneling of the NAV receiver will cause the HLD light to illuminate. The DME will "hold" the frequency it was tuned to at the time the button was depressed.

DISPLAYS

1. NM Display

a. VOR and VOR-PAR modes

Displays DME distance in 0.1 NM increments from 0 to 99.9 NM and in 1 NM increments from 100 to 200 NM. Displays dashes whenever DME goes into search.

b. RNV APR and RNV ENR modes

Displays RNAV distance to waypoint in 0.1 NM increments from 0 to 99.9 NM and in 1 NM increments from 100 to 400 NM. Displays dashes if DME is in search, if VOR flags, or if the VOR is rechanneled with the HOLD button depressed.

2. KT Display

a. VOR and VOR-PAR modes

Displays ground speed to the DME ground station in 1 knot increments from 0 to 999 knots. Displays dashes whenever DME goes into search.

b. RNV APR and RNV ENR modes

Displays ground speed to the active waypoint in increments of 1 knot from 0 to 999 knots. Displays dashes whenever DME goes into search, if VOR flags or if the VOR is rechanneled with the HOLD button depressed.

3. MIN Display

a. VOR and VOR-PAR modes

Displays time to DME ground station in 1 minute increments from 0 to 99 minutes. Displays dashes whenever DME goes into search or when calculated time exceeds 99 minutes.

b. RNV APR and RNV ENR modes

Displays time to the active waypoint in 1 minute increments from 0 to 99 minutes. Displays dashes if DME is in search, if VOR flags, if the VOR is rechanneled with the HOLD button depressed, or if calculated time exceeds 99 minutes.

4. FRQ, RAD, DST Display

a. FRQ mode

Displays frequency from 108.00 to 117.95 MHz in

FAA Approved
Issued January, 1980
P/N 105-590000-25

increments of .05 MHz. Least significant digit displays only zero or five.

b. RAD mode

Displays ground station radial on which waypoint is located from 0.0 to 359.9 degrees.

c. DST mode

Displays the offset distance of the waypoint from the ground station over a range of 0.0 to 199.9 NM.

5. USE Display

Displays waypoint number of data (1 to 4) actually being used by the system. In VOR modes only the frequency has meaning. When changed, always takes on DSP value.

6. DSP Display

Displays waypoint number (1 to 4) of data being displayed.

7. PAR, VOR, ENR, APR, RNV Displays

System status lights.

8. HLD Display

Indicates when the station to which the DME is actually tuned is different that the station to which the VOR is tuned.

9. DATA Display

Displays waypoint data. The messages FRQ, DST, and RAD tell what is being displayed at any one time.

10. ILS Display

Indicates that the frequency in use is an ILS frequency.

CONTROL

1. VOR Button

Momentary pushbutton which, when pushed while the system is in either RNV mode, causes the system to go to VOR mode. Otherwise, the button causes the system to toggle between VOR and VOR-PAR modes.

2. RNAV Button

Momentary pushbutton which, when pushed while the system is in either VOR mode, causes the system to go to RNV ENR mode. Otherwise the button causes the system to toggle between RNV ENR and RNV APR modes.

3. HOLD Button

Two position pushbutton which, when in the depressed position, inhibits DME from channeling to a new station when the VOR frequency is changed. Pushing the button again releases the button and channels the DME to the station paired with the VOR station.

4. USE Button

Momentary pushbutton which, when pressed, causes the active waypoint to take on the same value as the

FAA Approved
Issued January, 1980
P/N 105-590000-25

displayed waypoint and the DATA display to go to FRQ mode.

5. DSP Button

Momentary pushbutton which, when pushed, causes displayed waypoint to increment by 1 and DATA display to go to FREQUENCY mode.

6. DATA Button

Momentary pushbutton which, when pressed, causes waypoint DATA display to change from FRQ to RAD to DST and back to FRQ.

7. OFF/PULL ID Control

Rotary switch/potentiometer which, when turned clockwise, applies power to the KNS-80 and increases audio level. Turned counterclockwise it will decrease audio level and switch off power. The switch may be pulled out to hear VOR ident.

8. DATA INPUT Control

Dual concentric knobs with the center knob having an "in" and "out" position.

a. Frequency Data

The outer knob varies the 1MHz digit and the center knob varies the frequency in .05 MHz increments regardless of whether the switch is in its "in" or "out" position.

b. Radial Data

The outer knob varies the 10 degree digit with a

carryover occurring from the tens to hundreds position. The center knob in the "in" position varies the 1 degree digit and in the "out" position varies the 0.1 degree digit.

c. Distance Data

The outer knob varies the 10 NM digit with a carryover occurring from the tens to hundreds place. The center knob in the "in" position varies the 1 NM digit and in the "out" position varies the 0.1 NM digit.

HANDLING SERVICE AND MAINTENANCE

BATTERY REPLACEMENT

The waypoint memory is powered by two silver oxide watch cells located in the lower left hand corner of the front panel. Typical life of the cells is two years although high temperature and humidity conditions can shorten this period. If the batteries should become weak, waypoint storage will be lost and the radio will "wake up" tuned to 110.00 MHz in the VOR mode. The cells can be replaced by opening the battery pocket with a thin blade screwdriver. The holder was designed so that the cells can only be inserted with the correct polarity.

APPROVED:

Donald St. Peter

For

W. H. Schultz
Beech Aircraft Corporation
DOA CE-2

FAA Approved
Issued January, 1980
P/N 105-590000-25

SAFETY INFORMATION

Beechcraft
Twin Engine (Piston)

SECTION X
SAFETY INFORMATION
TABLE OF CONTENTS

| <i>SUBJECT</i> | <i>PAGE</i> |
|---|-------------|
| Introduction | 3 |
| General | 5 |
| Do's | 5 |
| Don'ts | 6 |
| Sources of Information | 7 |
| Pilot's Operating Handbook and FAA Approved Airplane Flight Manual | 7 |
| BEEHCRAFT Service Publications | 7 |
| Federal Aviation Regulations | 9 |
| Airworthiness Directives | 10 |
| Airman's Information Manual | 10 |
| Advisory Information | 11 |
| FAA Advisory Circulars | 11 |
| FAA General Aviation News | 15 |
| FAA Accident Prevention Program | 15 |
| Additional Information | 16 |
| General Information on Specific Topics | 17 |
| Maintenance | 17 |
| Hazards of Unapproved Modifications | 19 |
| Flight Planning | 20 |
| Passenger Information Cards | 20 |
| Stowage of Articles | 21 |
| Flight Operations | 21 |
| General | 21 |
| Preflight Inspection | 21 |
| Weight and Balance | 22 |
| Autopilots and Electric Trim Systems | 23 |
| Flutter | 26 |
| Turbulent Weather | 28 |
| Wind Shear | 30 |
| Flight in Icing Conditions | 31 |
| Weather Radar | 36 |
| Mountain Flying | 39 |
| VFR - Low Ceilings | 39 |

SECTION X
SAFETY INFORMATION
TABLE OF CONTENTS (Continued)

| <i>SUBJECT</i> | <i>PAGE</i> |
|---|--------------------|
| VFR at Night | 40 |
| Vertigo - Disorientation | 40 |
| Flight of Multi-Engine Airplanes With One Engine Inoperative | 42 |
| Air Minimum Control Speed (VMCA) | 44 |
| Intentional One-Engine Inoperative Speed (VSSE) | 45 |
| One-Engine-Inoperative Best Rate-of-Climb Speed (VYSE) | 45 |
| One-Engine-Inoperative Best Angle-of-Climb Speed (VXSE) | 46 |
| Single Engine Service Ceiling | 46 |
| Basic Single Engine Procedures | 46 |
| Engine Failure on Takeoff | 47 |
| When to Fly V _X , V _Y , V _{XSE} and V _{YSE} | 48 |
| Stalls, Slow Flight and Training | 48 |
| Spins | 51 |
| Descent | 53 |
| Vortices - Wake Turbulence | 54 |
| Takeoff and Landing Conditions | 55 |
| Medical Facts for Pilots | 55 |
| General | 55 |
| Fatigue | 56 |
| Hypoxia | 56 |
| Hyperventilation | 58 |
| Alcohol | 59 |
| Drugs | 60 |
| Scuba Diving | 61 |
| Carbon Monoxide and Night Vision | 61 |
| Decompression Sickness | 61 |
| A Final Word | 63 |

INTRODUCTION

Beech Aircraft Corporation has developed this special summary publication of safety information to refresh pilots' and owners' knowledge of safety related subjects. Topics in this publication are dealt with in more detail in FAA Advisory Circulars and other publications pertaining to the subject of safe flying.

The skilled pilot recognizes that safety consciousness is an integral - and never-ending - part of his or her job. Be thoroughly familiar with your airplane. Know its limitations and your own. Maintain your currency, or fly with a qualified instructor until you are current and proficient. Practice emergency procedures at safe altitudes and airspeeds, preferably with a qualified instructor pilot, until the required action can be accomplished without reference to the manual. Periodically review this Safety Information as part of your recurrency training regimen.

BEEHCRAFT airplanes are designed and built to provide you with many years of safe and efficient transportation. By maintaining your BEEHCRAFT properly and flying it prudently you will realize its full potential.

..... Beech Aircraft Corporation

WARNING

Because your airplane is a high performance, high speed transportation vehicle, designed for operation in a three-dimensional environment, special safety precautions must be observed to reduce the risk of fatal or serious injuries to the pilot(s) and occupant(s).

It is mandatory that you fully understand the contents of this publication and the other operating and maintenance manuals which accompany the airplane; that FAA requirements for ratings, certifications and review be scrupulously complied with; and that you allow only persons who are properly licensed and rated, and thoroughly familiar with the contents of the Pilot's Operating Handbook and FAA Approved Airplane Flight Manual to operate the airplane.

IMPROPER OPERATION OR MAINTENANCE OF AN AIRPLANE, NO MATTER HOW WELL BUILT INITIALLY, CAN RESULT IN CONSIDERABLE DAMAGE OR TOTAL DESTRUCTION OF THE AIRPLANE, ALONG WITH SERIOUS OR FATAL INJURIES TO ALL OCCUPANTS.

Don't trust to luck.

SOURCES OF INFORMATION

There is a wealth of information available to the pilot created for the sole purpose of making your flying safer, easier and more efficient. Take advantage of this knowledge and be prepared for an emergency in the event that one should occur.

PILOT'S OPERATING HANDBOOK AND FAA APPROVED AIRPLANE FLIGHT MANUAL

You must be thoroughly familiar with the contents of your operating manuals, placards, and check lists to ensure safe utilization of your airplane. When the airplane was manufactured, it was equipped with one or more of the following: placards, Owner's Manual, FAA Flight Manual, Approved Airplane Flight Manual Supplements, Pilot's Operating Handbook and FAA Approved Airplane Flight Manual. Beech has revised and reissued many of the early manuals for certain models of airplanes in GAMA Standard Format as Pilot's Operating Handbooks and FAA Approved Airplane Flight Manuals. For simplicity and convenience, all official manuals in various models are referred to as the Pilot's Operating Handbook and FAA Approved Airplane Flight Manual. If the airplane has changed ownership, the Pilot's Operating Handbook and FAA Approved Airplane Flight Manual may have been misplaced or may not be current. Replacement handbooks may be obtained from any BEECHCRAFT Authorized Outlet.

BEECHCRAFT SERVICE PUBLICATIONS

Beech Aircraft Corporation publishes a wide variety of manuals, service letters, service instructions, service bulletins, safety communiques and other publications for the various models of BEECHCRAFT airplanes. Information on how

**Section X
Safety Information**

**Beechcraft
Twin Engine (Piston)**

to obtain publications relating to your airplane is contained in BEEHCRAFT Service Bulletin number 2001, entitled "General - BEEHCRAFT Service Publications - What is Available and How to Obtain It."

Beech Aircraft Corporation automatically mails original issues and revisions of BEEHCRAFT Service Bulletins (Mandatory, Recommended and Optional), FAA Approved Airplane Flight Manual Supplements, reissues and revisions of FAA Approved Airplane Flight Manuals, Flight Handbooks, Owners Manuals, Pilot's Operating Manuals and Pilot's Operating Handbooks, and original issues and revisions of BEEHCRAFT Safety Communiques to BEEHCRAFT Owner addresses as listed by the FAA Aircraft Registration Branch List and the BEEHCRAFT International Owner Notification Service List. While this information is distributed by Beech Aircraft Corporation, Beech can not make changes in the name or address furnished by the FAA. The owner must contact the FAA regarding any changes to name or address. Their address is: FAA Aircraft Registration Branch (AAC250) P.O. Box 25082, Oklahoma City, OK 73125, Phone (405) 680-2131.

It is the responsibility of the FAA owner of record to ensure that any mailings from Beech are forwarded to the proper persons. Often the FAA registered owner is a bank or financing company or an individual not in possession of the airplane. Also, when an airplane is sold, there is a lag in processing the change in registration with the FAA. If you are a new owner, contact your BEEHCRAFT Authorized Outlet and ensure your manuals are up to date.

Beech Aircraft Corporation provides a subscription service which provides for direct factory mailing of BEEHCRAFT publications applicable to a specific serial number airplane. Details concerning the fees and ordering information for this owner subscription service are contained in Service Bulletin number 2001.

For owners who choose not to apply for a Publications Revision Subscription Service, Beech provides a free Owner

Notification Service by which owners are notified by post card of BEEHCRAFT manual reissues, revisions and supplements which are being issued applicable to the airplane owned. On receipt of such notification, the owner may obtain the publication through a BEEHCRAFT Authorized Outlet. This notification service is available when requested by the owner. This request may be made by using the owner notification request card furnished with the loose equipment of each airplane at the time of delivery, or by a letter requesting this service, referencing the specific airplane serial number owned. Write to :

Supervisor, Special Services
Dept. 52
Beech Aircraft Corporation
P.O. Box 85
Wichita, Kansas 67201-0085

From time to time Beech Aircraft Corporation issues BEEHCRAFT Safety Communiques dealing with the safe operation of a specific series of airplanes, or airplanes in general. It is recommended that each owner/operator maintain a current file of these publications. Back issues of BEEHCRAFT Safety Communiques may be obtained without charge by sending a request, including airplane model and serial number, to the Supervisor, Special Services, at the address listed above.

Airworthiness Directives (AD's) are not issued by the manufacturer. They are issued and available from the FAA.

FEDERAL AVIATION REGULATIONS

FAR Part 91, General Operating and Flight Rules, is a document of law governing operation of airplanes and the owner's and pilot's responsibilities. Some of the subjects covered are:

Responsibilities and authority of the pilot-in-command

**Section X
Safety Information**

**Beechcraft
Twin Engine (Piston)**

Certificates required
Liquor and Drugs
Flight plans
Preflight action
Fuel requirements
Flight Rules

Maintenance, preventive maintenance, alterations, inspection and maintenance records

You, as a pilot, have responsibilities under government regulations. The regulations are designed for your protection and the protection of your passengers and the public. Compliance is mandatory.

AIRWORTHINESS DIRECTIVES

FAR Part 39 specifies that no person may operate a product to which an Airworthiness Directive issued by the FAA applies, except in accordance with the requirements of that Airworthiness Directive.

AIRMAN'S INFORMATION MANUAL

The Airman's Information Manual (AIM) is designed to provide airmen with basic flight information and ATC procedures for use in the national airspace system of the United States. It also contains items of interest to pilots concerning health and medical facts, factors affecting flight safety, a pilot/controller glossary of terms in the Air Traffic Control system, information on safety, and accident/hazard reporting. It is revised at six-month intervals and can be purchased from the Superintendent of Documents, U.S. Government Printing Office, Washington, D.C. 20402.

This document contains a wealth of pilot information. Among the subjects are:

Controlled Airspace

Emergency Procedures
Services Available to Pilots
Weather and Icing
Radio Phraseology and Technique
Mountain Flying
Airport Operations
Wake Turbulence - Vortices
Clearances and Separations
Medical Facts for Pilots
Preflight
Bird Hazards
Departures - IFR
Good Operating Practices
Enroute - IFR
Airport Location Directory
Arrival - IFR

All pilots must be thoroughly familiar with and use the information in the AIM.

ADVISORY INFORMATION

NOTAMS (Notices to Airmen) are documents that have information of a time-critical nature that would affect a pilot's decision to make a flight; for example, an airport closed, terminal radar out of service, or enroute navigational aids out of service.

FAA ADVISORY CIRCULARS

The FAA issues Advisory Circulars to inform the aviation public in a systematic way of nonregulatory material of interest. Advisory Circulars contain a wealth of information with which the prudent pilot should be familiar. A complete list of current FAA Advisory Circulars is published in AC 00-2, which lists Advisory Circulars that are for sale, as well as those distributed free of charge by the FAA, and provides

**Section X
Safety Information**

**Beechcraft
Twin Engine (Piston)**

ordering information. Many Advisory Circulars which are for sale can be purchased locally in aviation bookstores or at FBO's. These documents are subject to periodic revision. Be certain the Advisory Circular you are using is the latest revision available. Some of the Advisory Circulars of interest to pilots are:

- | | |
|---------------|---|
| *00-6 | Aviation Weather |
| 00-24 | Thunderstorms |
| 00-30 | Rules of Thumb for Avoiding or Minimizing Encounters with Clear Air Turbulence |
| *00-45 | Aviation Weather Services |
| 00-46 | Aviation Safety Reporting Program |
| 20-5 | Plane Sense |
| 20-32 | Carbon Monoxide (CO) Contamination in Aircraft - Detection and Prevention |
| 20-35 | Tie-Down Sense |
| 20-43 | Aircraft Fuel Control |
| 20-105 | Engine-Power Loss Accident Prevention |
| 20-113 | Pilot Precautions and Procedures to be Taken in Preventing Aircraft Reciprocating Engine Induction System and Fuel System Icing Problems |
| 20-125 | Water in Aviation Fuels |
| 21-4 | Special Flight Permits for Operation of Overweight Aircraft |
| 43-9 | Maintenance Records: General Aviation Aircraft |

| | |
|---------------|--|
| 43-12 | Preventive Maintenance |
| 60-4 | Pilot's Spatial Disorientation |
| 60-6 | Airplane Flight Manuals (AFM), Approved Manual Materials, Markings and Placards - Airplanes |
| 60-12 | Availability of Industry-Developed Guidelines for the Conduct of the Bien- nial Flight Review |
| 60-13 | The Accident Prevention Counselor Program |
| *61-9 | Pilot Transition Courses for Complex Single-Engine and Light Twin-Engine Airplanes |
| *61-21 | Flight Training Handbook |
| *61-23 | Pilot's Handbook of Aeronautical Knowledge |
| *61-27 | Instrument Flying Handbook |
| 61-67 | Hazards Associated with Spins in Air- planes Prohibited from Intentional Spinning. |
| 61-84 | Role of Preflight Preparation |
| *67-2 | Medical Handbook for Pilots |
| 90-23 | Aircraft Wake Turbulence |
| 90-42 | Traffic Advisory Practices at Nontower Airports |
| 90-48 | Pilot's Role in Collision Avoidance |
| 90-66 | Recommended Standard Traffic Pat- terns for Airplane Operations at Uncontrolled Airports |

**Section X
Safety Information**

**Beechcraft
Twin Engine (Piston)**

- 90-85** Severe Weather Avoidance Plan (SWAP)
- 91-6** Water, Slush and Snow on the Runway
- 91-13** Cold Weather Operation of Aircraft
- *91-23** Pilot's Weight and Balance Handbook
- 91-26** Maintenance and Handling of Air Driven Gyroscopic Instruments
- 91-33** Use of Alternate Grades of Aviation Gasoline for Grade 80/87
- 91-35** Noise, Hearing Damage, and Fatigue in General Aviation Pilots
- 91-43** Unreliable Airspeed Indications
- 91-44** Operational and Maintenance Practices for Emergency Locator Transmitters and Receivers
- 91-46** Gyroscopic Instruments - Good Operating Practices
- 91-50** Importance of Transponder Operations and Altitude Reporting
- 91-51** Airplane Deice and Anti-ice Systems
- 91-59** Inspection and Care of General Aviation Aircraft Exhaust Systems
- 91-65** Use of Shoulder Harness in Passenger Seats
- 103-4** Hazards Associated with Sublimation of Solid Carbon Dioxide (Dry Ice) Aboard Aircraft
- 135-9** FAR Part 135 Icing Limitations

210-5A

Military Flying Activities

*** For Sale**

FAA GENERAL AVIATION NEWS

FAA General Aviation News is published by the FAA in the interest of flight safety. The magazine is designed to promote safety in the air by calling the attention of general aviation airmen to current technical, regulatory and procedural matters affecting the safe operation of airplanes. FAA General Aviation News is sold on subscription by the Superintendent of Documents, Government Printing Office, Washington D.C., 20402.

FAA ACCIDENT PREVENTION PROGRAM

The FAA assigns accident prevention specialists to each Flight Standards and General Aviation District Office to organize accident prevention program activities. In addition, there are over 3,000 volunteer airmen serving as accident prevention counselors, sharing their technical expertise and professional knowledge with the general aviation community. The FAA conducts seminars and workshops, and distributes invaluable safety information under this program.

Usually the airport manager, the FAA Flight Service Station (FSS), or Fixed Base Operator (FBO), will have a list of accident prevention counselors and their phone numbers available. All Flight Standards and General Aviation District Offices have a list of the counselors serving the District.

Before flying over unfamiliar territory, such as mountainous terrain or desert areas, it is advisable for transient pilots to consult with local counselors. They will be familiar with the more desirable routes, the wind and weather conditions, and the service and emergency landing areas that are available along the way. They can also offer advice on the type of emergency equipment you should be carrying.

ADDITIONAL INFORMATION

The National Transportation Safety Board and the Federal Aviation Administration periodically issue, in greater detail, general aviation pamphlets concerning aviation safety. FAA Regional Offices also publish material under the FAA General Aviation Accident Prevention Program. These can be obtained at FAA Offices, Weather Stations, Flight Service Stations or Airport Facilities. Some of these are titled:

12 Golden Rules for Pilots
Weather or Not
Disorientation
Plane Sense
Weather Info Guide for Pilots
Wake Turbulence
Don't Trust to Luck, Trust to Safety
Rain, Fog, Snow
Thunderstorm - TRW
Icing
Pilot's Weather Briefing Guide
Thunderstorms Don't Flirt ... Skirt 'em
IFR-VFR - Either Way Disorientation Can Be Fatal
IFR Pilot Exam-O-Grams
VFR Pilot Exam-O-Grams
Flying Light Twins Safely
Tips on Engine Operation in Small General Aviation Aircraft
Estimating Inflight Visibility
Is the Aircraft Ready for Flight
Tips on Mountain Flying
Tips on Desert Flying
Always Leave Yourself An Out
Safety Guide for Private Aircraft Owners
Tips on How to Use the Flight Planner
Tips on the Use of Ailerons and Rudder
Some Hard Facts About Soft Landings

Propeller Operation and Care
Torque "What it Means to the Pilot"
Weight and Balance. An Important Safety Consideration for Pilots

GENERAL INFORMATION ON SPECIFIC TOPICS

MAINTENANCE

Safety of flight begins with a well maintained airplane. Make it a habit to keep your airplane and all of its equipment in airworthy condition. Keep a "squawk list" on board, and see that all discrepancies, however minor, are noted and promptly corrected.

Schedule your maintenance regularly, and have your airplane serviced by a reputable organization. Be suspicious of bargain prices for maintenance, repair and inspections.

It is the responsibility of the owner and the operator to assure that the airplane is maintained in an airworthy condition and that proper maintenance records are kept.

Use only genuine BEEHCRAFT or BEEHCRAFT approved parts obtained from BEEHCRAFT approved sources, in connection with the maintenance and repair of Beech airplanes.

Genuine BEEHCRAFT parts are produced and inspected under rigorous procedures to insure airworthiness and suitability for use in Beech airplane applications. Parts purchased from sources other than BEEHCRAFT, even though outwardly identical in appearance, may not have had the required tests and inspections performed, may be different in fabrication techniques and materials, and may be dangerous when installed in an airplane.

Section X
Safety Information

Beechcraft
Twin Engine (Piston)

Salvaged airplane parts, reworked parts obtained from non-BEEHCRAFT approved sources or parts, components, or structural assemblies, the service history of which is unknown or cannot be authenticated, may have been subjected to unacceptable stresses or temperatures or have other hidden damage not discernible through routine visual or usual nondestructive testing techniques. This may render the part, component or structural assembly, even though originally manufactured by BEEHCRAFT, unsuitable and unsafe for airplane use.

BEEHCRAFT expressly disclaims any responsibility for malfunctions, failures, damage or injury caused by use of non-BEEHCRAFT parts.

Airplanes operated for Air Taxi or other than normal operation, and airplanes operated in humid tropics, or cold and damp climates, etc., may need more frequent inspections for wear, corrosion and/or lack of lubrication. In these areas, periodic inspections should be performed until the operator can set his own inspection periods based on experience.

NOTE

The required periods do not constitute a guarantee that the item will reach the period without malfunction, as the aforementioned factors cannot be controlled by the manufacturer.

Corrosion and its effects must be treated at the earliest possible opportunity. A clean, dry surface is virtually immune to corrosion. Make sure that all drain holes remain unobstructed. Protective films and sealants help to keep corrosive agents from contacting metallic surfaces. Corrosion inspections should be made most frequently under high-corrosion-risk operating conditions, such as in areas of

excessive airborne salt concentrations (e.g., near the sea) and in high-humidity areas (e.g., tropical regions).

If you have purchased a used airplane, have your mechanic inspect the airplane registration records, logbooks and maintenance records carefully. An unexplained period of time for which the airplane has been out of service, or unexplained significant repairs may well indicate the airplane has been seriously damaged in a prior accident. Have your mechanics inspect a used airplane carefully. Take the time to ensure that you really know what you are buying when you buy a used airplane.

HAZARDS OF UNAPPROVED MODIFICATIONS

Many airplane modifications are approved under Supplemental Type Certificates (STC's). Before installing an STC on your airplane, check to make sure that the STC does not conflict with other STC's that have already been installed. Because approval of an STC is obtained by the individual STC holder based upon modification of the original type design, it is possible for STC's to interfere with each other when both are installed. Never install an unapproved modification of any type, however innocent the apparent modification may seem. Always obtain proper FAA approval.

Airplane owners and maintenance personnel are particularly cautioned not to make attachments to, or otherwise modify, seats from original certification without approval from the FAA Engineering and Manufacturing District Office having original certification responsibility for that make and model.

Any unapproved attachment or modification to seat structure may increase load factors and metal stress which could cause failure of seat structure at a lesser "G" force than exhibited for original certification.

Section X Safety Information

**Beechcraft
Twin Engine (Piston)**

Examples of unauthorized attachments found are drilling holes in seat tubing to attach fire extinguishers and drilling holes to attach approach plate book bins to seats.

FLIGHT PLANNING

FAR Part 91 requires that each pilot in command, before beginning a flight, familiarize himself with all available information concerning that flight.

Obtain a current and complete preflight briefing. This should consist of local, enroute and destination weather and enroute navaid information. Enroute terrain and obstructions, alternate airports, airport runways active, length of runways, and takeoff and landing distances for the airplane for conditions expected should be known.

The prudent pilot will review his planned enroute track and stations and make a list for quick reference. It is strongly recommended a flight plan be filed with Flight Service Stations, even though the flight may be VFR. Also, advise Flight Service Stations of changes or delays of one hour or more and remember to close the flight plan at destination.

The pilot must be completely familiar with the performance of the airplane and performance data in the Pilot's Operating Handbook and FAA Approved Airplane Flight Manual. The resultant effect of temperature and pressure altitude must be taken into account in performance if not accounted for on the charts. An applicable FAA Approved Airplane Flight Manual must be aboard the airplane at all times and include the weight and balance forms and equipment list.

PASSENGER INFORMATION CARDS

Beech has available, for most current production airplanes, passenger information cards which contain important information on the proper use of restraint systems, oxygen

masks, emergency exits and emergency bracing procedures. Passenger information cards may be obtained at any BEECHCRAFT Authorized Outlet. A pilot should not only be familiar with the information contained in the cards, but should always, prior to flight, inform the passengers of the information contained in the information cards. The pilot should orally brief the passengers on the proper use of restraint systems, doors and emergency exits, and other emergency procedures, as required by Part 91 of the FAR's.

STOWAGE OF ARTICLES

The space between the seat pan and the floor is utilized to provide space for seat displacement. If hard, solid objects are stored beneath seats, the energy absorbing feature is lost and severe spinal injuries can occur to occupants.

Prior to flight, pilots should insure that articles are not stowed beneath seats that would restrict seat pan energy absorption or penetrate the seat in event of a high vertical velocity accident.

FLIGHT OPERATIONS

GENERAL

The pilot **MUST** be thoroughly familiar with **ALL INFORMATION** published by the manufacturer concerning the airplane; and is required by law to operate the airplane in accordance with the FAA Approved Airplane Flight Manual and placards installed.

PREFLIGHT INSPECTION

In addition to maintenance inspections and preflight information required by FAR Part 91, a complete, careful preflight inspection is imperative.

Each airplane has a checklist for the preflight inspection which must be followed. **USE THE CHECKLIST.**

WEIGHT AND BALANCE

Maintaining center of gravity within the approved envelope throughout the planned flight is an important safety consideration.

The airplane must be loaded so as not to exceed the weight and center of gravity (C.G.) limitations. Airplanes that are loaded above the maximum takeoff or landing weight limitations will have an overall lower level of performance compared to that shown in the Performance section of the Pilot's Operating Handbook and FAA Approved Airplane Flight Manual. If loaded above maximum takeoff weight, takeoff distance and the landing distance will be longer than that shown in the Performance section; the stalling speed will be higher, rate of climb, the cruising speed, and the range of the airplane at any level of fuel will all be lower than shown in the Performance section.

If an airplane is loaded so that the C.G. is forward of the forward limit it will require additional control movements for maneuvering the airplane with correspondingly higher control forces. The pilot may have difficulty during takeoff and landing because of the elevator control limits.

If an airplane is loaded aft of the aft C.G. limitation, the pilot will experience a lower level of stability. Airplane characteristics that indicate a lower stability level are; lower control forces, difficulty in trimming the airplane, lower control forces for maneuvering with attendant danger of structural overload, decayed stall characteristics, and a lower level of lateral-directional damping.

Ensure that all cargo and baggage is properly secured before takeoff. A sudden shift in balance at rotation can cause controllability problems.

AUTOPILOTS AND ELECTRIC TRIM SYSTEMS

Because there are several different models of autopilots and electric trim systems installed in Beech airplanes and different installations and switch positions are possible from airplane to airplane, it is essential that every owner/operator review his Airplane Flight Manual (AFM) Supplements and ensure that the supplements properly describe the autopilot and trim installations on his specific airplane. Each pilot, prior to flight, must be fully aware of the proper procedures for operation, and particularly disengagement, for the system as installed.

In addition to ensuring compliance with the autopilot manufacturer's maintenance requirements, all owners/operators should thoroughly familiarize themselves with the operation, function and procedures described in the Airplane Flight Manual Supplements. Ensure a full understanding of the methods of engagement and disengagement of the autopilot and trim systems.

Compare the descriptions and procedures contained in the Supplements to the actual installation in the airplane to ensure that the supplement accurately describes your installation. Test that all buttons, switches and circuit breakers function as described in the Supplements. If they do not function as described, have the system repaired by a qualified service agency. If field service advice or assistance is necessary, contact Beech Aircraft Corporation, Customer Support Department.

As stated in all AFM Supplements for autopilot systems and trim systems installed on Beech airplanes, the preflight check must be conducted before every flight. The preflight check assures not only that the systems and all of their features are operating properly, but also that the pilot, before flight, is familiar with the proper means of engagement and disengagement of the autopilot and trim system.

**Section X
Safety Information**

**Beechcraft
Twin Engine (Piston)**

Autopilot Airplane Flight Manual Supplements caution against trying to override the autopilot system during flight without disengaging the autopilot because the autopilot will continue to trim the airplane and oppose the pilot's actions. This could result in a severely out of trim condition. This is a basic feature of all autopilots with electric trim follow-up.

Do not try to manually override the autopilot during flight.

IN CASE OF EMERGENCY, YOU CAN OVERPOWER THE AUTOPILOT TO CORRECT THE ATTITUDE, BUT THE AUTOPILOT AND ELECTRIC TRIM MUST THEN IMMEDIATELY BE DISENGAGED.

It is often difficult to distinguish an autopilot malfunction from an electric trim system malfunction. The safest course is to deactivate both. Do not re-engage either system until after you have safely landed. Then have the systems checked by a qualified service facility prior to further flight.

Depending upon the installation on your airplane, the following additional methods may be available to disengage the autopilot or electric trim in the event that the autopilot or electric trim does not disengage utilizing the disengage methods specified in the Supplements.

CAUTION

Transient control forces may occur when the autopilot is disengaged.

1. Turn off the autopilot master switch, if installed.
2. Pull the autopilot and trim circuit breaker(s) or turn off the autopilot switch breaker, if installed.
3. Turn off the RADIO MASTER SWITCH, if installed, and

if the autopilot system and the trim system are wired through this switch.

CAUTION

Radios, including VHF COMM are also disconnected when the radio master switch is off.

4. Turn off the ELECTRIC MASTER SWITCH.

WARNING

Most electrically powered systems will be inoperative. Consult the AFM for further information.

5. Push the GA switch on throttle grip, if installed (depending upon the autopilot system).
6. Push TEST EACH FLT switch on the autopilot controller, if installed.

NOTE

After the autopilot is positively disengaged, it may be necessary to restore other electrical functions. Be sure when the master switches are turned on that the autopilot does not re-engage.

The above ways may or may not be available on your autopilot. It is essential that you read your airplane's AFM

Section X
Safety Information

Beechcraft
Twin Engine (Piston)

SUPPLEMENT for your autopilot system and check each function and operation on your system.

The engagement of the autopilot must be done in accordance with the instructions and procedures contained in the **AFM SUPPLEMENT**.

Particular attention must be paid to the autopilot settings prior to engagement. If you attempt to engage the autopilot when the airplane is out of trim, a large attitude change may occur.

IT IS ESSENTIAL THAT THE PROCEDURES SET FORTH IN THE APPROVED AFM SUPPLEMENTS FOR YOUR SPECIFIC INSTALLATION BE FOLLOWED BEFORE ENGAGING THE AUTOPILOT.

FLUTTER

Flutter is a phenomenon that can occur when an aerodynamic surface begins vibrating. The energy to sustain the vibration is derived from airflow over the surface. The amplitude of the vibration can (1) decrease, if airspeed is reduced; (2) remain constant, if airspeed is held constant and no failures occur; or (3) increase to the point of self-destruction, especially if airspeed is high and/or is allowed to increase. Flutter can lead to an in-flight break up of the airplane. Airplanes are designed so that flutter will not occur in the normal operating envelope of the airplane as long as the airplane is properly maintained. In the case of any airplane, decreasing the damping and stiffness of the structure or increasing the trailing edge weight of control surfaces will tend to cause flutter. If a combination of those factors is sufficient, flutter can occur within the normal operating envelope.

Owners and operators of airplanes have the primary responsibility for maintaining their airplanes. To fulfill that responsibility, it is imperative that all airplanes receive a thorough

preflight inspection. Improper tension on the control cables or any other loose condition in the flight control system can also cause or contribute to flutter. Pilots should pay particular attention to control surface attachment hardware including tab pushrod attachment during preflight inspection. Looseness of fixed surfaces or movement of control surfaces other than in the normal direction of travel should be rectified before flight. Further, owners should take their airplanes to mechanics who have access to current technical publications and prior experience in properly maintaining that make and model of airplane. The owner should make certain that control cable tension inspections are performed as outlined in the applicable Beech Inspection Guide. Worn control surface attachment hardware must be replaced. Any repainting or repair of a moveable control surface will require a verification of the control surface balance before the airplane is returned to service. Control surface drain holes must be open to prevent freezing of accumulated moisture, which could create an increased trailing-edge-heavy control surface and flutter.

If an excessive vibration, particularly in the control column and rudder pedals, is encountered in flight, this may be the onset of flutter and the procedure to follow is:

1. **IMMEDIATELY REDUCE AIRSPEED** (lower the landing gear, if necessary).
2. **RESTRAIN THE CONTROLS OF THE AIRPLANE UNTIL THE VIBRATION CEASES.**
3. **FLY AT THE REDUCED AIRSPEED AND LAND AT THE NEAREST SUITABLE AIRPORT.**
4. **HAVE THE AIRPLANE INSPECTED FOR AIRFRAME DAMAGE, CONTROL SURFACE ATTACHING HARDWARE CONDITION/SECURITY, TRIM TAB FREE PLAY, PROPER CONTROL CABLE TENSION, AND CONTROL SURFACE BALANCE BY ANOTHER MECHANIC WHO IS FULLY QUALIFIED.**

TURBULENT WEATHER

A complete and current weather briefing is a requirement for a safe trip.

Updating of weather information en route is also essential. The wise pilot knows that weather conditions can change quickly, and treats weather forecasting as professional advice, rather than an absolute fact. He obtains all the advice he can, but stays alert to any sign or report of changing conditions.

Plan the flight to avoid areas of reported severe turbulence. It is not always possible to detect individual storm areas or find the in-between clear areas.

The National Weather Service classifies turbulence as follows:

| Class of Turbulence | Effect |
|----------------------------|--|
| Extreme | Airplane is violently tossed about and is practically impossible to control. May cause structural damage. |
| Severe | Airplane may be momentarily out of control. Occupants are thrown violently against the belts and back into the seat. Unsecured objects are tossed about. |
| Moderate | Occupants require seat belts and occasionally are thrown against the belt. Unsecured objects move about. |

Light Occupants may be required to use seat belts, but objects in the airplane remain at rest.

Thunderstorms, squall lines and violent turbulence should be regarded as extremely dangerous and must be avoided. Hail and tornadic wind velocities can be encountered in thunderstorms that can destroy any airplane, just as tornadoes destroy nearly everything in their path on the ground.

Thunderstorms also pose the possibility of a lightning strike on an airplane. Any structure or equipment which shows evidence of a lightning strike, or of being subjected to a high current flow due to a strike, or is a suspected part of a lightning strike path through the airplane should be thoroughly inspected and any damage repaired prior to additional flight.

A roll cloud ahead of a squall line or thunderstorm is visible evidence of extreme turbulence; however, the absence of a roll cloud should not be interpreted as denoting that severe turbulence is not present.

Even though flight in severe turbulence must be avoided, flight in turbulent air may be encountered unexpectedly under certain conditions.

The following recommendations should be observed for airplane operation in turbulent air:

Flying through turbulent air presents two basic problems, the answer to both of which is proper airspeed. On one hand, if you maintain an excessive airspeed, you run the risk of structural damage or failure; on the other hand, if your airspeed is too low, you may stall.

If turbulence is encountered, reduce speed to the turbulent air penetration speed, if given, or to the maneuvering speed, which is listed in the Limitations section of the Pilot's Operating Handbook and FAA Approved Airplane Flight Manual.

Section X
Safety Information

Beechcraft
Twin Engine (Piston)

These speeds give the best assurance of avoiding excessive stress loads, and at the same time provide the proper margin against inadvertent stalls due to gusts.

Beware of overcontrolling in an attempt to correct for changes in attitude; applying control pressure abruptly will build up G-forces rapidly and could cause structural damage or even failure. You should watch particularly your angle of bank, making turns as wide and shallow as possible. Be equally cautious in applying forward or back pressure to keep the airplane level. Maintain straight and level attitude in either up or down drafts. Use trim sparingly to avoid being grossly out of trim as the vertical air columns change velocity and direction. If necessary to avoid excessive airspeeds, lower the landing gear.

WIND SHEAR

Wind shears are rapid, localized changes in wind direction, which can occur vertically as well as horizontally. Wind shear can be very dangerous to all airplanes, large and small, particularly on approach to landing when airspeeds are slow.

A horizontal wind shear is a sudden change in wind direction or speed that can, for example, transform a headwind into a tailwind, producing a sudden decrease in indicated airspeed because of the inertia of the airplane. A vertical wind shear, is a sudden updraft or downdraft. Microbursts are intense, highly localized severe downdrafts.

The prediction of wind shears is far from an exact science. Monitor your airspeed carefully when flying near storms, particularly on approach. Be mentally prepared to add power and go around at the first indication that a wind shear is being encountered.

FLIGHT IN ICING CONDITIONS

Every pilot should be intimately acquainted with the FAA Approved National Weather Service definitions for ice intensity and accumulation which we have reprinted below:

| Intensity | Ice Accumulation |
|------------------|--|
| Trace | Ice becomes perceptible. Rate of accumulation slightly greater than rate of sublimation. It is not hazardous even though deicing/anti-icing equipment is not utilized, unless encountered for an extended period of time (over 1 hour). |
| Light | The rate of accumulation may create a problem if flight is prolonged in this environment (over 1 hour). Occasional use of deicing/anti-icing equipment removes/prevents accumulation. It does not present a problem if the deicing/anti-icing equipment is used. |
| Moderate | The rate of accumulation is such that even short encounters become potentially hazardous and use of deicing/anti-icing equipment or diversion is necessary. |
| Severe | The rate of accumulation is such that deicing/anti-icing equipment fails to reduce or control the hazard. Immediate diversion is necessary. |

It is no longer unusual to find deicing and anti-icing equipment on a wide range of airplane sizes and types. Since the capability of this equipment varies, it becomes the pilot's primary responsibility to understand limitations which restrict the use of his airplane in icing conditions and the conditions which may exceed the systems capacity.

**Section X
Safety Information**

**Beechcraft
Twin Engine (Piston)**

Pilots and airplane owners must carefully review the Pilot's Operating Handbook and FAA Approved Airplane Flight Manual in order to ascertain the required operable equipment needed for flight in icing conditions. In addition, they must ascertain from the same source the limits of approval or certification of their airplane for flight in icing conditions, and plan the flight accordingly, if icing conditions are known or forecast along the route.

Every owner and pilot of an airplane should understand that it is not uncommon to find airplanes equipped with less than the full complement of available systems and equipment. For example, propellers and pitot tube may be protected, but the airplane may not have wing boots or tail boots. The reverse might be true. Windshield, pitot and airfoil surfaces might be protected, but the propellers might not be. Before undertaking any flight into areas where icing conditions might be expected, inspect the airplane and review the Pilot's Operating Handbook and FAA Approved Airplane Flight Manual to be certain that you are supported by the full complement of required IFR and deicing/anti-icing equipment.

Remember that regardless of its combination of deicing/anti-icing equipment, any airplane not fully equipped and functional for IFR flight is not properly equipped for flight in icing conditions. An airplane which is not approved or certificated for flight in icing conditions, or which does not have all critical areas protected in the required manner by fully operational anti-icing equipment must not be exposed to icing encounters of any intensity. When icing is detected, the pilot of such an airplane must make an immediate diversion by flying out of the area of visible moisture or going to an altitude where icing is not encountered.

Some models of Beech airplanes were approved for flight in certain limited icing conditions under the FAA's Bureau of Flight Standards Release No. 434. Under this release, properly equipped airplanes are approved for flight in light to

moderate icing conditions only. Refer to Sections 2 and 4 of the above document for icing limitations. These airplanes are not approved for extended flight in moderate icing conditions or flights in any severe icing conditions. Flight in these conditions must be avoided.

Even airplanes fully equipped and certified for flight in the icing conditions described in Appendix C to FAR Part 25 must avoid flights into those conditions defined by the National Weather Service as "Severe". The National Weather Service definition of "Severe Icing" describes that conditions as: "the rate of accumulation is such that deicing/anti-icing equipment fails to reduce or control the hazard." No airplane equipped with any combination of deicing/anti-icing equipment can be expected to cope with such conditions. As competent pilots know, there appears to be no predictable limits for the severest weather conditions. For essentially the same reasons that airplanes, however designed or equipped for IFR flight, cannot be flown safely into conditions such as thunderstorms, tornadoes, hurricanes or other phenomena likely to produce severe turbulence, airplanes equipped for flight in icing conditions cannot be expected to cope with "Severe" icing conditions as defined by the National Weather Service. The prudent pilot must remain alert to the possibility that icing conditions may become "severe" and that his equipment will not cope with them. At the first indication that such condition may have been encountered or may lie ahead, he should immediately react by selecting the most expeditious and safe course for diversion.

Every pilot of a properly fully-equipped Beech airplane who ventures into icing conditions must maintain the minimum speed (KIAS) for operation in icing conditions, which is set forth in the Normal Procedures section, and in the Limitations section, of his Pilot's Operating Handbook and FAA Approved Airplane Flight Manual. If a minimum speed for flight in icing conditions is not specified in the manual, the following minimum indicated airspeeds must be maintained:

**Section X
Safety Information**

**Beechcraft
Twin Engine (Piston)**

All Baron and Travel Air Models - 130 KIAS

All other BEEHCRAFT twin-engine models - 140 KIAS

The pilot must remain aware of the fact that if he allows his airspeed to deteriorate below this minimum speed, he will increase the angle of attack of his airplane to the point where ice may build up on the under side of the wings aft of the area protected by the boots.

The fact or extent of ice build-up in unprotected areas will not be directly observable from the cockpit. Due to distortion of the wing airfoil, increased drag and reduced lift, stalling speeds will increase as ice accumulates on the airplane. For the same reasons, stall warning devices are not accurate and cannot be relied upon in icing conditions.

Even though the pilot maintains the prescribed minimum speeds for operating in icing conditions, ice is still likely to build up on the unprotected areas (the fuselage and unprotected wing leading edge inboard of the engine nacelle). Under some atmospheric conditions, it may even build up aft of the boots despite the maintenance of the prescribed minimum speed. The effect of ice accumulation on any unprotected surface is aggravated by length of exposure to the icing conditions. Ice buildup on unprotected surfaces will increase drag, add weight, reduce lift, and generally, adversely affect the aerodynamic characteristics and performance of the airplane. It can progress to the point where the airplane is no longer capable of flying. Therefore, the pilot operating even a fully-equipped airplane in sustained icing conditions must remain sensitive to any indication, such as observed ice accumulation, loss of airspeed, the need for increased power, reduced rate of climb, or sluggish response, that ice is accumulating on unprotected surfaces and that continued flight in these conditions is extremely hazardous, regardless of the performance of the deicing/anti-icing equipment.

Since flight in icing conditions is not an everyday occurrence, it is important that pilots maintain a proper proficiency and awareness of the operating procedures necessary for safe operation of the airplane and that the airplane is in a condition for safe operation.

Ensure moisture drains in the airplane structure are maintained open as specified in the Aircraft Maintenance Manual, so that moisture will not collect and cause freezing in the control cable area. Also, control surface tab hinges should be maintained and lubricated as specified in the Aircraft Maintenance Manual.

In icing conditions the autopilot should be disengaged at an altitude sufficient to permit the pilot to gain the feel of the airplane prior to landing. In no case should this be less than the minimum altitude specified in the Autopilot Airplane Flight Manual Supplement.

Observe the procedures set forth in your Pilot's Operating Handbook and FAA Approved Airplane Flight Manual during operation in icing conditions.

Activate your deice and anti-icing systems before entering an area of moisture where you are likely to go through a freezing level, to make sure all necessary equipment is operative.

Rapid cycling of deice boots or cycling before at least one-half inch (1/2") of ice has accumulated (measured in the chordwise direction or forward from the leading edge), may cause the ice to grow outside the contour of the inflated boots and prevent ice removal.

For any owner or pilot whose use pattern for an airplane exposes it to icing encounters, the following references are required reading for safe flying:

- The airplane's Pilot's Operating Handbook and FAA

Section X
Safety Information

Beechcraft
Twin Engine (Piston)

Approved Airplane Flight Manual, especially the sections on Normal Procedures, Emergency Procedures, Abnormal Procedures, Systems, and Safety Information.

- FAA Advisory Circulars 91-51 Airplane Deice and Anti-ice Systems
- FAA Advisory Circulars 135-9 - Icing Limitations
- Weather Flying by Robert N. Buck.

Finally, the most important ingredients to safe flight in icing conditions - regardless of the airplane or the combination of deicing/anti-icing equipment - are a complete and current weather briefing, sound pilot judgement, close attention to the rate and type of ice accumulations, and the knowledge that "severe icing" as defined by the National Weather Service is beyond the capability of modern airplanes and immediate diversion must be made. It is the inexperienced or uneducated pilot who presses on "regardless", hoping that steadily worsening conditions will improve, only to find himself flying an airplane which has become so loaded with ice that he can no longer maintain altitude. At this point he has lost most, if not all, of his safety options, including perhaps a 180 degree turn to return along the course already traveled.

The responsible and well-informed pilot recognizes the limitations of weather conditions, his airplane and its systems, and reacts promptly.

WEATHER RADAR

Airborne weather avoidance radar is, as its name implies, for avoiding severe weather--not for penetrating it. Whether to fly into an area of radar echoes depends on echo intensity and shape, spacing between the echoes, and the capabilities of you and your airplane. Remember that weather radar detects only precipitation drops. Therefore, the radar scope provides no assurance of avoiding turbulence. The radar scope also does not provide assurance of avoiding

instrument weather from clouds and fog. Your scope may be clear between intense echoes; this clear area does not necessarily mean you can fly between the storms and maintain visual sighting of them.

Thunderstorms build and dissipate rapidly. Therefore, do not attempt to plan a course between echoes using ground based radar. The best use of ground radar information is to isolate general areas and coverage of echoes. You must avoid individual storms from in-flight observations either by visual sighting or by airborne radar. It is better to avoid the whole thunderstorm area than to detour around individual storms unless they are scattered.

Remember that while hail always gives a radar echo, it may fall several miles from the nearest visible cloud and hazardous turbulence may extend to as much as 20 miles from the echo edge. The intensity of the radar echo from hail varies with the size and nature of the hailstone. A hailstone with a wet surface gives a strong radar return while a dry hailstone gives a relatively weak return. Avoid intense or extreme level echoes by at least 20 miles; that is, such echoes should be separated by at least 40 miles before you fly between them. With weaker echoes you can reduce the distance by which you avoid them.

Above all, remember this: never regard any thunderstorm lightly. Even when radar observers report the echoes are of light intensity, avoiding thunderstorms is the best policy. The following are some do's and don'ts of thunderstorm avoidance:

1. Don't land or take off in the face of an approaching thunderstorm. A sudden gust front of low level turbulence could cause loss of control.
2. Don't attempt to fly under a thunderstorm even if you can see through to the other side. Turbulence and wind shear under the storm could be disastrous.

**Section X
Safety Information**

**Beechcraft
Twin Engine (Piston)**

3. Don't fly without airborne radar into a cloud mass containing scattered embedded thunderstorms. Embedded thunderstorms usually can not be visually circumnavigated.
4. Don't trust visual appearance to be a reliable indicator of the turbulence inside a thunderstorm.
5. Do avoid by at least 20 miles any thunderstorm identified as severe or giving an intense radar echo. This is especially true under the anvil of a large cumulonimbus.
6. Do circumnavigate the entire area if the area has 6/10 or greater thunderstorm coverage.
7. Do remember that vivid and frequent lightning indicates the probability of a severe thunderstorm.
8. Do regard as extremely hazardous any thunderstorm with tops 35,000 feet or higher, whether the top is visually sighted or determined by radar.

If you cannot avoid penetrating a thunderstorm, the following are some do's BEFORE entering the storm:

9. Tighten your safety belt, put on your shoulder harness, and secure all loose objects.
10. Plan and hold your course to take you through the storm in minimum time.
11. To avoid the most critical icing, establish a penetration altitude below the freezing level or above the level of -15°C .
12. Verify that pitot heat is on and turn on carburetor heat or engine anti-ice. Icing can be rapid at any altitude and cause almost instantaneous power failure and/or loss of airspeed indication.

MOUNTAIN FLYING

Pilots flying in mountainous areas should inform themselves of all aspects of mountain flying, including the effects of topographic features on weather conditions. Many good articles have been published, and a synopsis of mountain flying operations is included in the FAA Airman's Information Manual, Part 1.

Avoid flight at low altitudes over mountainous terrain, particularly near the lee slopes. If the wind velocity near the level of the ridge is in excess of 25 knots and approximately perpendicular to the ridge, mountain wave conditions are likely over and near the lee slopes. If the wind velocity at the level of the ridge exceeds 50 knots, a strong mountain wave is probable with extreme up and down drafts and severe turbulence. The worst turbulence will be encountered in and below the rotor zone, which is usually 8 to 10 miles downwind from the ridge. This zone is sometimes characterized by the presence of "roll clouds" if sufficient moisture is present; altocumulus standing lenticular clouds are also visible signs that a mountain wave exists, but their presence is likewise dependent on moisture. Mountain wave turbulence can, of course, occur in dry air and the absence of such clouds should not be taken as assurance that mountain wave turbulence will not be encountered. A mountain wave downdraft may exceed the climb capability of your airplane. Avoid mountain wave downdrafts.

VFR - LOW CEILINGS

If you are not instrument rated, do not attempt "VFR on Top" or "Special VFR" flight or clearances. Being caught above a solid cloud layer when an emergency descent is required (or at destination) is an extremely hazardous position for the VFR pilot. Accepting a clearance out of airport control zones with no minimum ceiling and one-mile visibility as permitted with "Special VFR" is a foolish practice for the VFR pilot.

**Section X
Safety Information**

**Beechcraft
Twin Engine (Piston)**

Avoid areas of low ceilings and restricted visibility unless you are instrument rated and proficient and have an instrument equipped airplane. Then proceed with caution and with planned alternates.

VFR AT NIGHT

When flying VFR at night, in addition to the altitude appropriate for the direction of flight, pilots should maintain a safe minimum altitude as dictated by terrain, obstacles such as TV towers, or communities in the area flown. This is especially true in mountainous terrain, where there is usually very little ground reference. Minimum clearance is 2,000 feet above the highest obstacle en route. Do not depend on your ability to see obstacles in time to miss them. Flight on dark nights over sparsely populated country can be the same as IFR, and must be avoided by inexperienced or non-IFR rated pilots.

VERTIGO - DISORIENTATION

Disorientation can occur in a variety of ways. During flight, inner ear balancing mechanisms are subjected to varied forces not normally experienced on the ground. This, combined with loss of outside visual reference, can cause vertigo. False interpretations (illusions) result, and may confuse the pilot's conception of the attitude and position of his airplane.

Under VFR conditions, the visual sense, using the horizon as a reference, can override the illusions. Under low visibility conditions (night, fog, clouds, haze, etc.) the illusions predominate. Only through awareness of these illusions, and proficiency in instrument flight procedures, can an airplane be operated safely in a low visibility environment.

Flying in fog, dense haze or dust, cloud banks, or very low visibility, with strobe lights or rotating beacons turned on can

contribute to vertigo. They should be turned off in these conditions, particularly at night.

All pilot's should check the weather and use good judgment in planning flights. The VFR pilot should use extra caution in avoiding low visibility conditions.

Motion sickness often precedes or accompanies disorientation and may further jeopardize the flight.

Disorientation in low visibility conditions is not limited to VFR pilots. Although IFR pilots are trained to look at their instruments to gain an artificial visual reference as a replacement for the loss of a visual horizon, they do not always do so. This can happen when the pilot's physical condition will not permit him to concentrate on his instruments; when the pilot is not proficient in flying instrument conditions in the airplane he is flying; or, when the pilot's work load of flying by reference to his instruments is augmented by such factors as turbulence. Even an instrument rated pilot encountering instrument conditions, intentional or unintentional, should ask himself whether or not he is sufficiently alert and proficient in the airplane he is flying, to fly under low visibility conditions and in the turbulence anticipated or encountered.

If any doubt exists, the flight should not be made or it should be discontinued as soon as possible.

The result of vertigo is loss of control of the airplane. If the loss of control is sustained, it will result in an excessive speed accident. Excessive speed accidents occur in one of two manners, either as an inflight airframe separation or as a high speed ground impact; and they are fatal accidents in either case. All airplanes are subject to this form of accident.

For years, Beech Pilot's Operating Handbooks and FAA Approved Airplane Flight Manuals have contained instructions that the landing gear should be extended in any circumstance in which the pilot encounters IFR conditions

which approach the limits of his capability or his ratings. Lowering the gear in IFR conditions or flight into heavy or severe turbulence, tends to stabilize the airplane, assists in maintaining proper airspeed, and will substantially reduce the possibility of reaching excessive airspeeds with catastrophic consequences, even where loss of control is experienced.

Excessive speed accidents occur at airspeeds greatly in excess of two operating limitations which are specified in the manuals: Maximum maneuvering speed and the "red line" or maximum operating speed. Such speed limits are set to protect the structure of an airplane. For example, flight controls are designed to be used to their fullest extent only below the airplane's maximum maneuvering speed. As a result, the control surfaces should never be suddenly or fully deflected above maximum maneuvering speed. Turbulence penetration should not be performed above that speed. The accidents we are discussing here occur at airspeeds greatly in excess of these limitations. No airplane should ever be flown beyond its FAA approved operating limitations.

FLIGHT OF MULTI-ENGINE AIRPLANES WITH ONE ENGINE INOPERATIVE

The major difference between flying a twin-engine and single-engine airplane is knowing how to manage the flight if one engine loses power for any reason. Safe flight with one engine inoperative requires an understanding of the basic aerodynamics involved - as well as proficiency in engine out procedures.

Loss of power from one engine affects both climb performance and controllability of twin-engine airplanes. Climb performance depends on an excess of power over that required for level flight. Loss of power from one engine obviously represents a 50% loss of horsepower but, in virtually all twin-engine airplanes, climb performance is reduced by at least 80%. A study of the charts in your Pilot's Operating

Handbook and FAA Approved Airplane Flight Manual will confirm this fact. Single-engine climb performance depends on four factors:

| | |
|-----------------|---|
| Airspeed | too little, or too much, will decrease climb performance |
| Drag | gear, flaps, cowl flaps, prop, and speed |
| Power | amount available in excess of that needed for level flight |
| Weight | passengers, baggage, and fuel load greatly affect climb performance |

Loss of power on one engine creates yaw due to asymmetric thrust. Yaw forces must be balanced with the rudder. Loss of power on one engine also reduces airflow over the wing causing a roll toward the "dead" engine which must be balanced with the aileron. The net result of these forces cause the airplane to sideslip slightly toward the dead engine. This sideslip may be balanced by banking slightly (up to 5°) into the operating engine.

CAUTION

In the event of an engine failure with the main tanks less than one-quarter full, corrective action must be taken immediately to prevent large yaw angles from developing and causing stoppage of the remaining engine.

Airspeed is the key to safe single engine operations. For most twin-engine airplanes there is:

| Symbol | Description |
|------------------------|--|
| V_{MCA} | Airspeed below which directional control cannot be maintained |
| V_{SSE} | Airspeed below which an intentional engine cut should never be made |
| V_{YSE} | Airspeed that will give the best single engine rate-of-climb (or the slowest loss of altitude) |
| V_{XSE} | Airspeed that will give the steepest angle-of-climb with one engine out |

AIR MINIMUM CONTROL SPEED (V_{MCA})

V_{MCA} is designated by the red radial on the airspeed indicator and indicates the minimum control speed, airborne at sea level. V_{MCA} is determined by FAA regulations as the minimum airspeed at which it is possible to recover directional control of the airplane within 20 degrees heading change, and thereafter maintain straight flight, with not more than 5 degrees of bank if one engine fails suddenly with:

- Takeoff power on both engines
- Rearmost allowable center of gravity
- Flaps in takeoff position
- Propeller windmilling in takeoff pitch configuration

However, sudden engine failures rarely occur with all factors listed above, and therefore, the actual V_{MCA} in any particular situation may be a little slower than the red radial on the airspeed indicator. Most airplanes with an inoperative engine will not maintain level flight at maximum power at speeds at or near V_{MCA}. Consequently, it is not advisable to fly at speeds approaching V_{MCA}, except in training situations or during flight tests. Adhering to the practice of never flying at or below the published V_{MCA} speed for your airplane does not eliminate loss of directional control as a problem in the

event of an engine failure. The pilot must be prepared to use assertive control input to maintain airplane control following an engine failure.

***INTENTIONAL ONE-ENGINE INOPERATIVE
SPEED (V_{SSE})***

V_{SSE} is specified by the airplane manufacturer and is the minimum speed at which to perform intentional engine cuts. Use of V_{SSE} is intended to reduce the accident potential from loss of control after engine cuts at or near minimum control speed. V_{MCA} demonstrations are necessary in training but should only be made at safe altitude above the terrain and with power reduction on one engine made at or above V_{SSE} .

***ONE-ENGINE-INOPERATIVE BEST
RATE-OF-CLIMB SPEED (V_{YSE})***

V_{YSE} is designated by the blue radial on the airspeed indicator. V_{YSE} delivers the greatest gain in altitude in the shortest possible time, and is based on the following criteria:

- Critical engine inoperative, and its propeller in the minimum drag position.
- Operating engine set at not more than the maximum continuous power.
- Landing gear retracted.
- Wing flaps up.
- Cowl flaps as required for engine cooling.
- Airplanes flown at recommended bank angle (up to 5° into operating engine).

Drag caused by a windmilling propeller, extending landing gear, or flaps in the landing position, will severely degrade or destroy single engine climb performance. Since climb

Section X
Safety Information

Beechcraft
Twin Engine (Piston)

performance varies widely with type of airplane, weight, temperature, altitude, and airplane configuration, the climb gradient (altitude gain or loss per mile) may be marginal - or even negative - under some conditions. Study the Pilot's Operating Handbook and FAA Approved Airplane Flight Manual for your airplane and know what performance to expect with one engine out.

***ONE-ENGINE-INOPERATIVE BEST
ANGLE-OF-CLIMB SPEED (V_{XSE})***

V_{XSE} is used only to clear obstructions during initial climb-out as it gives the greatest altitude gain per unit of horizontal distance. It provides less engine cooling and requires more rudder control input than V_{YSE} .

SINGLE ENGINE SERVICE CEILING

The single engine service ceiling is the maximum altitude at which an airplane will climb at a rate of at least 50 feet per minute in smooth air, with one engine inoperative.

The single engine service ceiling chart should be used during flight planning to determine whether the airplane, as loaded, can maintain the Minimum En Route Altitude (MEA) if IFR, or terrain clearance if VFR, following an engine failure.

BASIC SINGLE ENGINE PROCEDURES

Know and follow, to the letter, the single-engine emergency procedures specified in your Pilot's Operating Handbook and FAA Approved Airplane Flight Manual for your specific make and model airplane. However, the basic fundamentals of all the procedures are as follows:

1. Maintain airplane control and airspeed at all times.
THIS IS CARDINAL RULE NUMBER ONE.
2. Usually, apply maximum power to the operating engine.

However, if the engine failure occurs at a speed below V_{MCA} , during cruise or in a steep turn, you may elect to use only enough power to maintain a safe speed and altitude. If the failure occurs on final approach, use power only as necessary to complete the landing.

3. Reduce drag to an absolute minimum.
4. Secure the failed engine and related sub-systems.

The first three steps should be done promptly and from memory. The check list should then be consulted to be sure that the inoperative engine is secured properly and that the appropriate switches are placed in the correct position. The airplane must be banked about 5° into the operating engine, with the "slip/skid" ball slightly out of center toward the operating engine, to achieve rated performance.

Another note of caution: Be sure to identify the dead engine, positively, before securing it. Remember: First identify the suspected engine (i.e., "Dead foot means dead engine"), second, verify with cautious throttle movement, then secure.

ENGINE FAILURE ON TAKEOFF

If an engine fails before attaining lift-off speed or below V_{MCA} , the only proper action is to discontinue the takeoff. If the engine fails after lift-off with the landing gear still down, the takeoff should still be discontinued if touchdown and roll-out on the remaining runway is still possible.

If you do find yourself in a position of not being able to climb, it is much better to reduce the power on the good engine and land straight ahead than try to force a climb and lose control.

Your Pilot's Operating Handbook and FAA Approved Airplane Flight Manual contains charts that are used in calculating the runway length required to stop if the engine fails

before reaching lift-off speed and also has charts showing the single-engine performance after lift-off.

Study your charts carefully. No airplane is capable of climbing out on one engine under all weight, pressure altitude, and temperature conditions. Know, before you take the actual runway, whether you can maintain control and climb out if you lose an engine while the gear is still down. It may be necessary to off-load some weight, or wait for more favorable temperatures.

WHEN TO FLY V_X , V_Y , V_{XSE} AND V_{YSE}

During normal two-engine operations, always fly V_Y (V_X if necessary for obstacle clearance) on initial climb out. Then, accelerate to your cruise climb airspeed, which may be V_Y plus 10 or 15 knots after you have obtained a safe altitude. Use of cruise climb airspeed will give you better engine cooling, increased inflight visibility and better fuel economy. However, at first indication of an engine failure during climb out, or while on approach, establish V_{YSE} or V_{XSE} , whichever is appropriate. (Consult your Pilot's Operating Handbook and FAA Approved Airplane Flight Manual for specifics.)

STALLS, SLOW FLIGHT AND TRAINING

The stall warning system must be kept operational at all times and must not be deactivated by interruption of circuits, circuit breakers, or fuses. Compliance with this requirement is especially important in all high performance multi-engine airplanes during engine-out practice or stall demonstrations, because the stall speed is critical in all low speed operations of high-performance airplanes.

Training should be accomplished under the supervision of a qualified instructor-pilot, with careful reference to the applicable sections of the FAA Practical Test Standards and FAA Pilot Transition Courses for Complex Single Engine and

Light Twin Engine Airplanes (AC61-9B). In particular, observe carefully the warnings in the Practical Test Standards.

The single-engine stall speed of a twin-engine airplane is generally slightly below the power off (engines idle) stall speed, for a given weight condition. Single-engine stalls should not be conducted in multi-engine airplanes by other than qualified engineering test pilots.

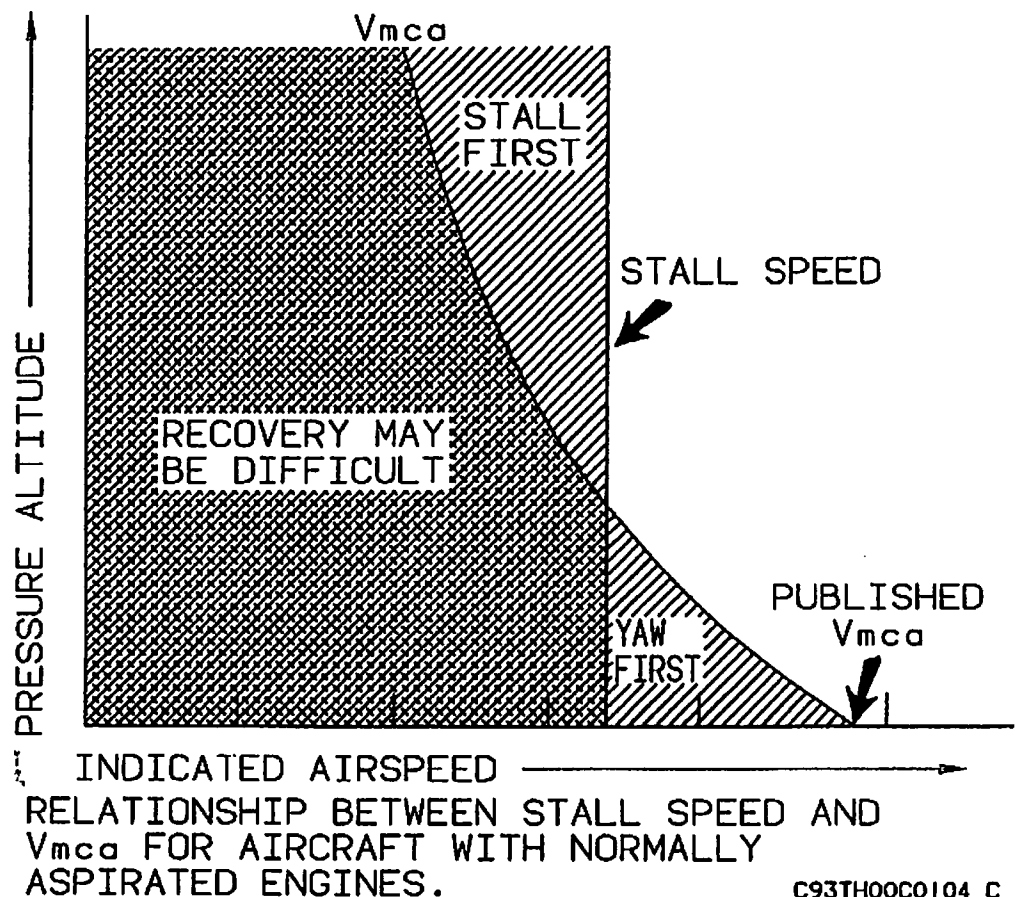

Engine-out minimum control speed generally decreases with altitude, while the single engine stall speed remains approximately constant for normally aspirated engines. No such demonstration should be attempted when the altitude and temperature are such that the engine-out minimum control

Section X
Safety Information

Beechcraft
Twin Engine (Piston)

speed is known, or discovered to be, close to the stalling speed. Loss of directional or lateral control, just as a stall occurs, is potentially hazardous.

V_{SSE} , the airspeed below which an engine should not be intentionally rendered inoperative for practice purposes, was established because of the apparent practice of some pilots, instructors, and examiners, of intentionally rendering an engine inoperative at a time when the airplane is being operated at a speed close to, or below the power-idle stall speed. Unless the pilot takes immediate and proper corrective action under such circumstances, it is possible to enter an inadvertent spin.

It is recognized that flight below V_{SSE} with one engine inoperative, or simulated inoperative, may be required for conditions such as practice demonstration of V_{MCA} for multi-engine pilot certification. Refer to the procedure set forth in the Pilot's Operating Handbook and FAA Approved Airplane Flight Manual for your airplane. This procedure calls for simulating one engine inoperative by reducing the power level (throttle) on one engine to idle while operating at an airspeed above V_{SSE} . Power on the other engine is set at maximum, then airspeed is reduced at approximately one knot per second until either V_{MCA} or stall warning is obtained. During this transition, rudder should be used to maintain directional control, and ailerons should be used to maintain a 5° bank toward the operative engine. At the first sign of either V_{MCA} or stall warning (which may be evidenced by inability to maintain longitudinal, lateral or directional control, aerodynamic stall buffet, or stall warning horn sound), recovery must be initiated immediately by reducing power to idle on operative engine and lowering the nose to regain V_{SSE} . Resume normal flight. This entire procedure should be used at a safe altitude of at least 5,000 feet above the ground in clear air only.

If stall warning is detected prior to the first sign of V_{MCA} , an engine-out minimum control speed demonstration cannot be

accomplished under the existing gross weight conditions and should not be attempted.

SPINS

A major cause of fatal accidents in general aviation airplanes is a spin. Stall demonstrations and practice are a means for a pilot to acquire the skills to recognize when a stall is about to occur and to recover as soon as the first signs of a stall are evident.

If a stall does not occur - A spin cannot occur. It is important to remember however, that a stall can occur in any flight attitude, at any airspeed, if controls are misused.

Unless your airplane has been specifically certificated in the aerobatic category and specifically tested for spin recovery characteristics, it is placarded against intentional spins. The pilot of an airplane placarded against intentional spins should assume that the airplane may become uncontrollable in a spin, since its performance characteristics beyond certain limits specified in the FAA regulations may not have been tested and are unknown. This is why airplanes are placarded against intentional spins, and this is why stall avoidance is your protection against an inadvertent spin.

Pilots are taught that intentional spins are entered by deliberately inducing a yawing moment with the controls as the airplane is stalled. Inadvertent spins result from the same combination - stall plus yaw. That is why it is important to use coordinated controls and to recover at the first indication of a stall when practicing stalls.

In any twin engine airplane, fundamental aerodynamics dictate that if the airplane is allowed to become fully stalled while one engine is providing lift-producing thrust, the yawing moment which can induce a spin will be present. Consequently, it is important to immediately reduce power on the operating engine, lower the nose to reduce the angle of attack, and increase the airspeed to recover from the stall.

**Section X
Safety Information**

**Beechcraft
Twin Engine (Piston)**

In any twin engine airplane, if application of stall recovery controls is delayed, a rapid rolling and yawing motion may develop, even against full aileron and rudder, resulting in the airplane becoming inverted during the onset of a spinning motion. Once the airplane has been permitted to progress beyond the stall and is allowed to reach the rapid rolling and yawing condition, the pilot must then immediately initiate the generally accepted spin recovery procedure for multi-engine airplanes, which is as follows:

Immediately move the control column full forward, apply full rudder opposite to the direction of the spin and reduce power on both engines to idle. These three actions should be done as near simultaneously as possible; then continue to hold this control position until rotation stops, then neutralize all controls and execute a smooth pullout. Ailerons should be neutral during recovery. **THE LONGER THE PILOT DELAYS BEFORE TAKING CORRECTIVE ACTION, THE MORE DIFFICULT RECOVERY WILL BECOME.**

Always remember that extra alertness and pilot techniques are required for slow flight maneuvers, including the practice or demonstration of stalls or V_{MCA} . In addition to the foregoing mandatory procedure, always:

- Be certain that the center of gravity of the airplane is as far forward as possible. Forward C.G. aids stall recovery, spin avoidance and spin recovery. An aft C.G. can create a tendency for a spin to stabilize, which delays recovery.
- Whenever a student pilot will be required to practice slow flight or single-engine maneuvers, be certain that the qualified instructor pilot has a full set of operable controls available. FAA regulations prohibit flight instruction without full dual controls.
- Conduct any maneuvers which could possibly result in a spin at altitudes in excess of five thousand (5,000) feet above ground level in clear air only.

- Remember that an airplane, at or near traffic pattern and approach altitudes, cannot recover from a spin, or perhaps even a stall, before impact with the ground. For twin engine airplanes, when descending to traffic altitude and during pattern entry and all other flight operations, maintain speed no lower than $V_{SS\bar{E}}$. On final approach maintain at least the airspeed shown in the flight manual. Should a go-around be required, do not apply more power than necessary until the airplane has accelerated to $V_{SS\bar{E}}$. Recognize that under some conditions of weight, density altitude, and airplane configuration, a twin engine airplane cannot climb or accelerate on a single engine. Hence a single engine go-around is impossible and the airplane is committed to a landing. Plan your approach accordingly.
- Remember that if an airplane flown under instrument conditions is permitted to stall or enter a spin, the pilot, without reference to the horizon, is certain to become disoriented. He may be unable to recognize a stall, spin entry, or the spin condition and he may be unable to determine even the direction of the rotation.
- Finally, never forget that stall avoidance is your best protection against an inadvertent spin. **MAINTAIN YOUR AIRSPEED.**

DESCENT

In twin engine piston-powered airplanes, supercharged or normally aspirated, it is necessary to avoid prolonged descents with low power, as this produces two problems: (1) excessively cool cylinder head temperatures which cause premature engine wear, and (2) excessively rich mixtures due to idle enrichment (and altitude) which causes soot and lead deposits on the spark plugs (fouling). The second of these is the more serious consideration; the engine may not respond to the throttle when it is desired to discontinue the descent. Both problems are amenable to one solution: maintain adequate power to keep cylinder head temperatures in

the "green" range during descent, and lean to best power mixture (that is, progressively enrich the mixture from cruise only slightly as altitude decreases). This procedure will lengthen the descent, of course, and requires some advance planning. If it is necessary to make a prolonged descent at or near idle, as in practicing forced landings, at least avoid the problem of fouled spark plugs by frequently advancing the throttle until the engine runs smoothly, and maintain an appropriate mixture setting with altitude. (Refer to pre-landing check list.)

VORTICES - WAKE TURBULENCE

Every airplane generates wakes of turbulence while in flight. Part of this is from the propeller or jet engine, and part from the wing tip vortices. The larger and heavier the airplane, the more pronounced and turbulent the wakes will be. Wing tip vortices from large, heavy airplanes are very severe at close range, degenerating with time, wind and distance. These are rolling in nature, from each wing tip. In tests, vortex velocities of 133 knots have been recorded. Encountering the rolling effect of wing tip vortices within two minutes after passage of large airplanes is most hazardous to light airplanes. This roll effect can exceed the maximum counter-roll obtainable in a light airplane. The turbulent areas may remain for as long as three minutes or more, depending on wind conditions, and may extend several miles behind the airplane. Plan to fly slightly above and to the windward side of other airplanes. Because of the wide variety of conditions that can be encountered, there is no set rule to follow to avoid wake turbulence in all situations. However, the Airman's Information Manual, and to a greater extent Advisory Circular 90-23, Aircraft Wake Turbulence, provide a thorough discussion of the factors you should be aware of when wake turbulence may be encountered.

TAKEOFF AND LANDING CONDITIONS

When taking off on runways covered with water or freezing slush, the landing gear should remain extended for approximately ten seconds longer than normal, allowing the wheels to spin and dissipate the freezing moisture. The landing gear should then be cycled up, then down, wait approximately five seconds and then retracted again. Caution must be exercised to insure that the entire operation is performed below Maximum Landing Gear Operating Airspeed.

Use caution when landing on runways that are covered by water or slush which cause hydroplaning (aquaplaning), a phenomenon that renders braking and steering ineffective because of the lack of sufficient surface friction. Snow and ice covered runways are also hazardous. The pilot should also be alert to the possibility of the brakes freezing.

Use caution when taking off or landing during gusty wind conditions. Also be aware of the special wind conditions caused by buildings or other obstructions located near the runway.

MEDICAL FACTS FOR PILOTS

GENERAL

When the pilot enters the airplane, he becomes an integral part of the man-machine system. He is just as essential to a successful flight as the control surfaces. To ignore the pilot in preflight planning would be as senseless as failing to inspect the integrity of the control surfaces or any other vital part of the machine. The pilot has the responsibility for determining his reliability prior to entering the airplane for flight. When piloting an airplane, an individual should be free of conditions which are harmful to alertness, ability to make correct decisions, and rapid reaction time.

FATIGUE

Fatigue generally slows reaction time and causes errors due to inattention. In addition to the most common cause of fatigue; insufficient rest and loss of sleep, the pressures of business, financial worries, and family problems can be important contributing factors. If you are tired, don't fly.

HYPOXIA

Hypoxia, in simple terms, is a lack of sufficient oxygen to keep the brain and other body tissues functioning properly. There is a wide individual variation in susceptibility to hypoxia. In addition to progressively insufficient oxygen at higher altitudes, anything interfering with the blood's ability to carry oxygen can contribute to hypoxia (anemias, carbon monoxide, and certain drugs). Also, alcohol and various drugs decrease the brain's tolerance to hypoxia.

Your body has no built-in alarm system to let you know when you are not getting enough oxygen. It is impossible to predict when or where hypoxia will occur during a given flight, or how it will manifest itself. Some of the common symptoms of hypoxia are increased breathing rate, a light-headed or dizzy sensation, tingling or warm sensation, sweating, reduced visual field, sleepiness, blue coloring of skin, fingernails, and lips, and behavior changes. A particularly dangerous feature of hypoxia is an increased sense of well-being, called euphoria. It obscures a person's ability and desire to be critical of himself, slows reaction time, and impairs thinking ability. Consequently, a hypoxic individual commonly believes things are getting progressively better while he nears total collapse.

The symptoms are slow but progressive, insidious in onset, and are most marked at altitudes starting above ten thousand feet. Night vision, however, can be impaired starting at an altitude of 5,000 feet. Persons who have recently indulged in alcohol, who are moderate to heavy smokers, or

who take certain drugs, may be more susceptible to hypoxia. Susceptibility may also vary in the same individual from day to day or even morning to evening. Use oxygen on flights above 10,000 feet and at any time when symptoms appear.

Depending upon altitude, a hypoxic individual has a limited time to make decisions and perform useful acts, even though he may remain conscious for a longer period. If pressurization equipment fails at certain altitudes the pilot and passengers have only a certain amount of time to get an oxygen mask on before they exceed their time of useful consciousness. The time of useful consciousness is approximately 3-5 minutes at 25,000 feet of altitude for the average individual and diminishes markedly as altitude increases. At 30,000 feet altitude, for example, the time of useful consciousness is approximately 1-2 minutes. Therefore, in the event of depressurization, oxygen masks should be used immediately.

Should symptoms occur that cannot definitely be identified as either hypoxia or hyperventilation, try three or four deep breaths of oxygen. The symptoms should improve markedly if the condition was hypoxia (recovery from hypoxia is rapid).

Pilots who fly to altitudes that require or may require the use of supplemental oxygen should be thoroughly familiar with the operation of the airplane oxygen systems. A preflight inspection of the system should be performed, including proper fit of the mask. The passengers should be briefed on the proper use of their oxygen system before flight.

Pilots who wear beards should be careful to ensure that their beard is carefully trimmed so that it will not interfere with proper sealing of the oxygen masks. If you wear a beard or moustache, test the fit of your oxygen mask on the ground for proper sealing. Studies conducted by the military and oxygen equipment manufacturers conclude that oxygen masks do not seal over beards or heavy facial hair.

**Section X
Safety Information**

**Beechcraft
Twin Engine (Piston)**

Federal Aviation Regulations related to the use of supplemental oxygen by flight crew and passengers must be adhered to if flight to higher altitudes is to be accomplished safely. Passengers with significant circulatory or lung disease may need to use supplemental oxygen at lower altitudes than specified by these regulations.

Pilots of pressurized airplanes should receive physiological training with emphasis on hypoxia and the use of oxygen and oxygen systems. Pilots of airplanes with pressure demand oxygen systems should undergo training, experience altitude chamber decompression, and be familiar with pressure breathing before flying at high altitude. This training is available throughout the United States at nominal cost. Information regarding this training may be obtained by request from the Chief, Civil Aeromedical Institute, Attention: Aeromedical Education Branch, AAC-140, Mike Monroney Aeronautical Center, P. O. Box 25082, Oklahoma City, Oklahoma 73125

HYPERVENTILATION

Hyperventilation, or overbreathing, is a disturbance of respiration that may occur in individuals as a result of emotional tension or anxiety. Under conditions of emotional stress, fright, or pain, breathing rate may increase, causing increased lung ventilation, although the carbon dioxide output of the body cells does not increase. As a result, carbon dioxide is "washed out" of the blood. The most common symptoms of hyperventilation are: dizziness, nausea, sleepiness, and finally, unconsciousness. If the symptoms persist discontinue use of oxygen and consciously slow your breathing rate until symptoms clear, and then resume normal breathing rate. Normal breathing can be aided by talking aloud.

ALCOHOL

Common sense and scientific evidence dictate that you must not fly as a crew member while under the influence of alcohol. Alcohol, even in small amounts, produces (among other things):

- A dulling of critical judgement.
- A decreased sense of responsibility.
- Diminished skill reactions and coordination.
- Decreased speed and strength of muscular reflexes (even after one ounce of alcohol).
- Decreases in efficiency of eye movements during reading (after one ounce of alcohol).
- Increased frequency of errors (after one ounce of alcohol).
- Constriction of visual fields.
- Decreased ability to see under dim illuminations.
- Loss of efficiency of sense of touch.
- Decrease of memory and reasoning ability.
- Increased susceptibility to fatigue and decreased attention span.
- Decreased relevance of response.
- Increased self confidence with decreased insight into immediate capabilities.

Tests have shown that pilots commit major errors of judgment and procedure at blood alcohol levels substantially less than the minimum legal levels of intoxication for most states. These tests further show a continuation of impairment from alcohol up to as many as 14 hours after consumption, with no appreciable diminution of impairment. The body metabolizes ingested alcohol at a rate of about one-third of an ounce per hour. Even after the body completely

**Section X
Safety Information**

**Beechcraft
Twin Engine (Piston)**

destroys a moderate amount of alcohol, a pilot can still be severely impaired for many hours by hangover. The effects of alcohol on the body are magnified at altitudes, as 2 oz. of alcohol at 18,000 feet produce the same adverse effects as 6 oz. at sea level.

Federal Aviation Regulations have been amended to reflect the FAA's growing concern with the effects of alcohol impairment. FAR 91 states:

"Alcohol or drugs.

(a) No person may act or attempt to act as a crew-member of a civil aircraft -

(1) Within 8 hours after the consumption of any alcoholic beverage;

(2) While under the influence of alcohol;

(3) While using any drug that affects the person's faculties in any way contrary to safety; or

(4) While having .04 percent by weight or more alcohol in the blood.

(b) Except in an emergency, no pilot of a civil aircraft may allow a person who appears to be intoxicated or who demonstrates by manner or physical indications that the individual is under the influence of drugs (except a medical patient under proper care) to be carried in that aircraft."

Because of the slow destruction of alcohol by the body, a pilot may still be under influence eight hours after drinking a moderate amount of alcohol. Therefore, an excellent rule is to allow at least 12 to 24 hours between "bottle and throttle," depending on the amount of alcoholic beverage consumed.

DRUGS

Self-medication or taking medicine in any form when you are flying can be extremely hazardous. Even simple home or

over-the-counter remedies and drugs such as aspirin, anti-histamines, cold tablets, cough mixtures, laxatives, tranquilizers, and appetite suppressors, may seriously impair the judgment and coordination needed while flying. The safest rule is to take no medicine before or while flying, except after consultation with your Aviation Medical Examiner.

SCUBA DIVING

Flying shortly after any prolonged scuba diving could be dangerous. Under the increased pressure of the water, excess nitrogen is absorbed into your system. If sufficient time has not elapsed prior to takeoff for your system to rid itself of this excess gas, you may experience the bends at altitudes even under 10,000 feet, where most light planes fly.

CARBON MONOXIDE AND NIGHT VISION

The presence of carbon monoxide results in hypoxia which will affect night vision in the same manner and extent as hypoxia from high altitudes. Even small levels of carbon monoxide have the same effect as an altitude increase of 8,000 to 10,000 feet. Smoking several cigarettes can result in a carbon monoxide saturation sufficient to affect visual sensitivity equal to an increase of 8,000 feet altitude.

DECOMPRESSION SICKNESS

Pilots flying unpressurized airplanes at altitudes in excess of 10,000 feet should be alert for the symptoms of 'decompression sickness'. This phenomenon, while rare, can impair the pilot's ability to perform and in extreme cases, can result in the victim being rendered unconscious. Decompression sickness, also known as dysbarism and aviator's "bends", is caused by nitrogen bubble formation in body tissue as the ambient air pressure is reduced by climbing to higher altitudes. The symptoms are pain in the joints, abdominal cramps, burning sensations in the skin, visual impairment

**Section X
Safety Information**

**Beechcraft
Twin Engine (Piston)**

and numbness. Some of these symptoms are similar to hypoxia. The only known remedy for decompression sickness is recompression, which can only be accomplished in an unpressurized airplane by descending. The pilot should immediately descend if it is suspected that this condition exists, since the effects will only worsen with continued exposure to the reduced pressure environment at altitude and could result, if uncorrected, in complete incapacitation. The possibility of decompression sickness can be greatly reduced by pre-breathing oxygen prior to flight and by commencing oxygen breathing well below the altitudes where it is legally mandatory.

A FINAL WORD

Airplanes are truly remarkable machines. They enable us to shrink distance and time, and to expand our business and personal horizons in ways that, not too many years ago, were virtually inconceivable. For many businesses, the general aviation airplane has become the indispensable tool of efficiency.

Advances in the mechanical reliability of the airplanes we fly have been equally impressive, as attested by the steadily declining statistics of accidents attributed to mechanical causes, at a time when the airframe, systems and power plants have grown infinitely more complex. The explosion in capability of avionics systems is even more remarkable. Radar, RNAV, LORAN, sophisticated autopilots and other devices which, just a few years ago, were too large and prohibitively expensive for general aviation size airplanes, are becoming increasingly commonplace in even the smallest airplanes.

It is thus that this Safety Information is directed to the pilot, for it is in the area of the skill and proficiency of you, the pilot, that the greatest gains in safe flying are to be made over the years to come. Intimate knowledge of your airplane, its capabilities and its limitations, and disciplined adherence to the procedures for your airplane's operation, will enable you to transform potential tragedy into an interesting hangar story when - as it inevitably will - the abnormal situation is presented.

Know your airplane's limitations, and your own. Never exceed either.

Safe flying,

BEECH AIRCRAFT CORPORATION

**THIS PAGE INTENTIONALLY LEFT
BLANK**